

STATE OF NORTH CAROLINA  
DEPARTMENT OF TRANSPORTATION  
RALEIGH, N.C.

C204603

CONTRACT AND  
CONTRACT BONDS

FOR CONTRACT NO. C204603

WBS 50401.3.GV1 NHPP-040-4(161)220

T.I.P NO. I-5711

COUNTY OF ALAMANCE  
THIS IS THE ROADWAY & STRUCTURE CONTRACT  
ROUTE NUMBER I 40 LENGTH 0.605 MILES  
LOCATION I-40/I-85 AND SR-1007 (MEBANE OAKS RD) IN MEBANE.

CONTRACTOR ZACHRY CONSTRUCTION CORPORATION  
ADDRESS P.O. BOX 33240  
SAN ANTONIO, TX 78265

BIDS OPENED MARCH 16, 2021  
CONTRACT EXECUTION 4/7/2021

STATE OF NORTH CAROLINA  
DEPARTMENT OF TRANSPORTATION  
RALEIGH, N.C.

PROPOSAL

**INCLUDES ADDENDUM No.1 DATED 03-08-2021**

DATE AND TIME OF BID OPENING: **MARCH 16, 2021 AT 2:00 PM**

CONTRACT ID C204603  
WBS 50401.3.GV1

FEDERAL-AID NO. NHPP-040-4(161)220  
COUNTY ALAMANCE  
T.I.P. NO. I-5711  
MILES 0.605  
ROUTE NO. I 40  
LOCATION I-40/I-85 AND SR-1007 (MEBANE OAKS RD) IN MEBANE.

TYPE OF WORK GRADING, DRAINAGE, PAVING, ITS, AND STRUCTURES.

**NOTICE:**

ALL BIDDERS SHALL COMPLY WITH ALL APPLICABLE LAWS REGULATING THE PRACTICE OF GENERAL CONTRACTING AS CONTAINED IN CHAPTER 87 OF THE GENERAL STATUTES OF NORTH CAROLINA WHICH REQUIRES THE BIDDER TO BE LICENSED BY THE N.C. LICENSING BOARD FOR CONTRACTORS WHEN BIDDING ON ANY NON-FEDERAL AID PROJECT WHERE THE BID IS \$30,000 OR MORE, EXCEPT FOR CERTAIN SPECIALTY WORK AS DETERMINED BY THE LICENSING BOARD. BIDDERS SHALL ALSO COMPLY WITH ALL OTHER APPLICABLE LAWS REGULATING THE PRACTICES OF ELECTRICAL, PLUMBING, HEATING AND AIR CONDITIONING AND REFRIGERATION CONTRACTING AS CONTAINED IN CHAPTER 87 OF THE GENERAL STATUTES OF NORTH CAROLINA. NOTWITHSTANDING THESE LIMITATIONS ON BIDDING, THE BIDDER WHO IS AWARDED ANY FEDERAL - AID FUNDED PROJECT SHALL COMPLY WITH CHAPTER 87 OF THE GENERAL STATUTES OF NORTH CAROLINA FOR LICENSING REQUIREMENTS WITHIN 60 CALENDAR DAYS OF BID OPENING.

**BIDS WILL BE RECEIVED AS SHOWN BELOW:**

**THIS IS A ROADWAY & STRUCTURE PROPOSAL**

**5% BID BOND OR BID DEPOSIT REQUIRED**

---

**PROPOSAL FOR THE CONSTRUCTION OF  
CONTRACT No. C204603 IN ALAMANCE COUNTY, NORTH CAROLINA**

Date \_\_\_\_\_ 20 \_\_\_\_\_

**DEPARTMENT OF TRANSPORTATION,  
RALEIGH, NORTH CAROLINA**

The Bidder has carefully examined the location of the proposed work to be known as Contract No. C204603 has carefully examined the plans and specifications, which are acknowledged to be part of the proposal, the special provisions, the proposal, the form of contract, and the forms of contract payment bond and contract performance bond; and thoroughly understands the stipulations, requirements and provisions. The undersigned bidder agrees to bound upon his execution of the bid and subsequent award to him by the Board of Transportation in accordance with this proposal to provide the necessary contract payment bond and contract performance bond within fourteen days after the written notice of award is received by him. The undersigned Bidder further agrees to provide all necessary machinery, tools, labor, and other means of construction; and to do all the work and to furnish all materials, except as otherwise noted, necessary to perform and complete the said contract in accordance with *the 2018 Standard Specifications for Roads and Structures* by the dates(s) specified in the Project Special Provisions and in accordance with the requirements of the Engineer, and at the unit or lump sum prices, as the case may be, for the various items given on the sheets contained herein.

The Bidder shall provide and furnish all the materials, machinery, implements, appliances and tools, and perform the work and required labor to construct and complete State Highway Contract No. C204603 in Alamance County, for the unit or lump sum prices, as the case may be, bid by the Bidder in his bid and according to the proposal, plans, and specifications prepared by said Department, which proposal, plans, and specifications show the details covering this project, and hereby become a part of this contract.

The published volume entitled *North Carolina Department of Transportation, Raleigh, Standard Specifications for Roads and Structures, January 2018* with all amendments and supplements thereto, is by reference incorporated into and made a part of this contract; that, except as herein modified, all the construction and work included in this contract is to be done in accordance with the specifications contained in said volume, and amendments and supplements thereto, under the direction of the Engineer.

If the proposal is accepted and the award is made, the contract is valid only when signed either by the Contract Officer or such other person as may be designated by the Secretary to sign for the Department of Transportation. The conditions and provisions herein cannot be changed except over the signature of the said Contract Officer.

The quantities shown in the itemized proposal for the project are considered to be approximate only and are given as the basis for comparison of bids. The Department of Transportation may increase or decrease the quantity of any item or portion of the work as may be deemed necessary or expedient.

An increase or decrease in the quantity of an item will not be regarded as sufficient ground for an increase or decrease in the unit prices, nor in the time allowed for the completion of the work, except as provided for the contract.

Accompanying this bid is a bid bond secured by a corporate surety, or certified check payable to the order of the Department of Transportation, for five percent of the total bid price, which deposit is to be forfeited as liquidated damages in case this bid is accepted and the Bidder shall fail to provide the required payment and performance bonds with the Department of Transportation, under the condition of this proposal, within 14 calendar days after the written notice of award is received by him, as provided in the *Standard Specifications*; otherwise said deposit will be returned to the Bidder.



*State Contract Officer*

DocuSigned by:

*Ronald E. Davenport, Jr.*

F81B6038A47A442...

3/8/2021

**TABLE OF CONTENTS**

**COVER SHEET  
PROPOSAL SHEET**

**PROJECT SPECIAL PROVISIONS**

CONTRACT TIME AND LIQUIDATED DAMAGES:..... G-1  
INTERMEDIATE CONTRACT TIME NUMBER 1 AND LIQUIDATED DAMAGES:..... G-1  
INTERMEDIATE CONTRACT TIME NUMBERS 2 THRU 7 AND LIQUIDATED  
DAMAGES: ..... G-2  
INTERMEDIATE CONTRACT TIME NUMBER 8 AND LIQUIDATED DAMAGES:..... G-3  
INTERMEDIATE CONTRACT TIME NUMBER 9 AND LIQUIDATED DAMAGES:..... G-4  
INTERMEDIATE CONTRACT TIME NUMBER 10 AND LIQUIDATED DAMAGES:..... G-5  
INTERMEDIATE CONTRACT TIME NUMBER 11 AND LIQUIDATED DAMAGES:..... G-5  
INTERMEDIATE CONTRACT TIME NUMBER 12 AND LIQUIDATED DAMAGES:..... G-6  
INTERMEDIATE CONTRACT TIME NUMBER 13 AND LIQUIDATED DAMAGES:..... G-6  
INTERMEDIATE CONTRACT TIME NUMBER 14 AND LIQUIDATED DAMAGES FOR  
FAILURE TO REPAIR A DAMAGED NCDOT ITS FIBER OPTIC COMMUNICATIONS  
CABLE AND RESTORE COMMUNICATION: ..... G-6  
INTERMEDIATE CONTRACT TIME NUMBERS 15 AND 16 AND LIQUIDATED DAMAGES  
FOR FAILURE TO REESTABLISH ITS FIBER OPTIC COMMUNICATIONS .....G-6  
PERMANENT VEGETATION ESTABLISHMENT:..... G-7  
AWARD OF CONTRACT: ..... G-8  
DELAY IN RIGHT OF ENTRY:..... G-8  
MAJOR CONTRACT ITEMS: ..... G-8  
SPECIALTY ITEMS: ..... G-9  
FUEL PRICE ADJUSTMENT:..... G-9  
SCHEDULE OF ESTIMATED COMPLETION PROGRESS:.....G-10  
DISADVANTAGED BUSINESS ENTERPRISE: .....G-10  
CERTIFICATION FOR FEDERAL-AID CONTRACTS:.....G-24  
CONTRACTOR'S LICENSE REQUIREMENTS: .....G-24  
RESTRICTIONS ON ITS EQUIPMENT AND SERVICES: .....G-24  
USE OF UNMANNED AIRCRAFT SYSTEM (UAS):.....G-25  
EQUIPMENT IDLING GUIDELINES: .....G-25  
U.S. DEPARTMENT OF TRANSPORTATION HOTLINE:.....G-26  
CARGO PREFERENCE ACT: .....G-26  
SUBSURFACE INFORMATION:.....G-27  
PORTABLE CONCRETE BARRIER - (Partial Payments for Materials): .....G-27  
MAINTENANCE OF THE PROJECT:.....G-27  
ELECTRONIC BIDDING: .....G-28  
TWELVE MONTH GUARANTEE: .....G-28  
EROSION AND SEDIMENT CONTROL/STORMWATER CERTIFICATION:.....G-29  
PROCEDURE FOR MONITORING BORROW PIT DISCHARGE:.....G-34

ROADWAY .....R-1

**STANDARD SPECIAL PROVISIONS**

AVAILABILITY FUNDS – TERMINATION OF CONTRACTS.....SSP-1  
 NCDOT GENERAL SEED SPECIFICATION FOR SEED QUALITY.....SSP-2  
 ERRATA .....SSP-5  
 PLANT AND PEST QUARANTINES.....SSP-6  
 TITLE VI AND NONDISCRIMINATION .....SSP-7  
 MINORITY AND FEMALE EMPLOYMENT REQUIREMENTS.....SSP-15  
 REQUIRED CONTRACT PROVISIONS FEDERAL-AID CONST. CONTRACTS .....SSP-18  
 ON-THE-JOB TRAINING.....SSP-27  
 MINIMUM WAGES.....SSP-30

**UNIT PROJECT SPECIAL PROVISIONS**

GEOTECHNICAL ..... GT-0.1  
 GEOENVIRONMENTAL.....GV-1  
 TRAFFIC CONTROL..... TC-1  
 LIGHTING ..... LT-1  
 UTILITY CONSTRUCTION ..... UC-1  
 UTILITY BY OTHERS ..... UBO-1  
 EROSION CONTROL ..... EC-1  
 TRAFFIC SIGNALS..... TS-1  
 STRUCTURE / CULVERTS ..... BP-1

**PROPOSAL ITEM SHEET**

ITEM SHEET(S) (TAN SHEETS)

**PROJECT SPECIAL PROVISIONS****GENERAL****CONTRACT TIME AND LIQUIDATED DAMAGES:**

(4-17-12)

108

SP1 G07 C

The date of availability for this contract is **April 26, 2021**.

The completion date for this contract is **January 11, 2024**.

Except where otherwise provided by the contract, observation periods required by the contract will not be a part of the work to be completed by the completion date and/or intermediate contract times stated in the contract. The acceptable completion of the observation periods that extend beyond the final completion date shall be a part of the work covered by the performance and payment bonds.

The liquidated damages for this contract are **Two Hundred Dollars (\$ 200.00)** per calendar day. These liquidated damages will not be cumulative with any liquidated damages which may become chargeable under Intermediate Contract Time Number 1.

**INTERMEDIATE CONTRACT TIME NUMBER 1 AND LIQUIDATED DAMAGES:**

(7-1-95) (Rev. 2-21-12)

108

SP1 G13 A

Except for that work required under the Project Special Provisions entitled *Planting, Reforestation* and/or *Permanent Vegetation Establishment*, included elsewhere in this proposal, the Contractor will be required to complete all work included in this contract and shall place and maintain traffic on same.

The date of availability for this intermediate contract time is **April 26, 2021**.

The completion date for this intermediate contract time is **July 15, 2023**.

The liquidated damages for this intermediate contract time are **Two Thousand Dollars (\$ 2,000.00)** per calendar day.

Upon apparent completion of all the work required to be completed by this intermediate date, a final inspection will be held in accordance with Article 105-17 and upon acceptance, the Department will assume responsibility for the maintenance of all work except *Planting, Reforestation* and/or *Permanent Vegetation Establishment*. The Contractor will be responsible for and shall make corrections of all damages to the completed roadway caused by his planting operations, whether occurring prior to or after placing traffic through the project.

**INTERMEDIATE CONTRACT TIME NUMBERS 2 THRU 7 AND LIQUIDATED****DAMAGES:**

(2-20-07)

108

SP1 G14 C

The Contractor shall complete the required work of installing, maintaining and removing the traffic control devices for lane closures and restoring traffic to the existing traffic pattern. The Contractor shall not close or narrow a lane of traffic on **the following roads** during the following time restrictions:

**DAY AND TIME RESTRICTIONS****ICT #2****-Y1- (I-40/I-85) Single Lane Closures****Monday through Sunday from 6:00 AM to 8:00 PM**

The liquidated damages are **One Thousand Two Hundred and Fifty Dollars (\$ 1,250.00)** per fifteen **(15)** minute time period.

**ICT #3****-Y1- (I-40/I-85) Double Lane Closures****Monday through Sunday from 6:00 AM to 10:00 PM**

The liquidated damages are **Two Thousand Dollars (\$ 2,000.00)** per fifteen **(15)** minute time period.

**ICT #4****-Y1- (I-40/I-85) Triple Lane Closures:****Monday through Sunday from 6:00 AM to 12:00 AM**

The liquidated damages are **Two Thousand Five Hundred Dollars (\$ 2,500.00)** per fifteen **(15)** minute time period.

**ICT #5****Any I-40/I-85 Ramp****Monday through Sunday from 6:00 AM to 8:00 PM**

The liquidated damages are **One Thousand Two Hundred and Fifty Dollars (\$ 1,250.00)** per fifteen **(15)** minute time period.

**ICT #6****-Y2- (Forest Oaks Ln), -Y3- (Brundage Ln)****Monday through Friday from 6:00 AM to 9:00 AM and from 4:00 PM to 6:00 PM**

The liquidated damages are **Two Hundred Fifty Dollars (\$ 250.00)** per hour.

ICT #7**-L- (Mebane Oaks Rd)**

**Monday through Friday from 6:00 AM to 9:00 AM and from 4:00 PM to 6:00 PM  
And Saturday and Sunday from 9:00 AM to 6:00 PM**

The liquidated damages are **One Thousand Two Hundred and Fifty Dollars (\$ 1,250.00)** per fifteen **(15)** minute time period.

The time of availability for **each of these intermediate contract times** will be the time the Contractor begins to install traffic control devices required for the lane closures according to the time restrictions stated herein.

The completion time for **each of these intermediate contract times** will be the time the Contractor is required to complete the removal of traffic control devices required for the lane closures according to the time restrictions stated herein and restore traffic to the existing traffic pattern.

**INTERMEDIATE CONTRACT TIME NUMBER 8 AND LIQUIDATED DAMAGES:**

(2-20-07)

108

SP1 G14 B

The Contractor shall not narrow or close a lane of traffic on **I-40/I-85 (including any associated Ramp), and/or -L-** , detain and /or alter the traffic flow on or during holiday weekends, special events, or any other time when traffic is unusually heavy, including the following schedules:

**HOLIDAY AND HOLIDAY WEEKEND LANE CLOSURE RESTRICTIONS**

1. For **unexpected occurrence** that creates unusually high traffic volumes, as directed by the Engineer.
2. For **New Year's Day**, between the hours of **6:00 AM** December 31<sup>st</sup> and **8:00 PM** January 2<sup>nd</sup>. If New Year's Day is on a Friday, Saturday, Sunday or Monday, then until **8:00 PM** the following Tuesday.
3. For **Easter**, between the hours of **6:00 AM** Thursday and **8:00 PM** Monday.
4. For **Memorial Day**, between the hours of **6:00 AM** Friday and **8:00 PM** Tuesday.
5. For **Independence Day**, between the hours of **6:00 AM** the day before Independence Day and **8:00 PM** the day after Independence Day.

If **Independence Day** is on a Friday, Saturday, Sunday or Monday, then between the hours of **6:00 AM** the Thursday before Independence Day and **8:00 PM** the Tuesday after Independence Day.

6. For **Labor Day**, between the hours of **6:00 AM** Friday and **8:00 PM** Tuesday.
7. For **Thanksgiving**, between the hours of **6:00 AM** Tuesday to **8:00 PM** Monday, for **-Y1- (I-40/I-85)** only.



8. For **Christmas**, between the hours of **6:00 AM** the Friday before the week of Christmas Day and **8:00 PM** the following Tuesday after the week of Christmas, for **-Y1-(I-40/I-85)** only.
9. For **Thanksgiving through the Christmas holiday period** beginning on the **Tuesday of the week of Thanksgiving** and ending on the following **Tuesday after the week of Christmas, for all ramps and -L- only:**  
  
**Monday through Thursday from 6:00 AM to 9:00AM and from 4:00 PM to 6:00 PM**  
**And Friday through Sunday from 6:00 AM to 8:00 PM**
10. For **football and basketball games at UNC in Chapel Hill**, between **three (3)** hours before the start and **two (2)** hours after the end of the **football and basketball games at UNC in Chapel Hill**.

Holidays and holiday weekends shall include New Year's, Easter, Memorial Day, Independence Day, Labor Day, Thanksgiving, and Christmas. The Contractor shall schedule his work so that lane closures are not required during these periods, unless otherwise directed by the Engineer.

The time of availability for this intermediate contract work shall be the time the Contractor begins to install all traffic control devices for lane closures according to the time restrictions listed herein.

The completion time for this intermediate contract work shall be the time the Contractor is required to complete the removal of all traffic control devices for lane closures according to the time restrictions stated herein and place traffic in the existing traffic pattern.

The liquidated damages are **Two Thousand Five Hundred Dollars (\$ 2,500.00)** per fifteen **(15)** minute time period.

**INTERMEDIATE CONTRACT TIME NUMBER 9 AND LIQUIDATED DAMAGES:**

(2-20-07)

108

SP1 G14 D

The Contractor shall complete the required work of installing, maintaining and removing the traffic control devices for road closures and restoring traffic to the existing traffic pattern. The Contractor shall not close **-Y1- (I-40/I-85)** during the following time restrictions:

**DAY AND TIME RESTRICTIONS**

**Monday through Sunday from 6:00 AM to 1:00 AM**

**For detouring traffic off-site when removing sections of the existing -L- bridge decking over -Y1- (Phase IA, Step #3) and when installing proposed -L- bridge girders over -Y1- (Phase IA, Step #5 and Phase II, Step #4).**

The time of availability for this intermediate contract time will be the time the Contractor begins to install traffic control devices required for road closures according to the time restrictions stated herein.

The completion time for this intermediate contract time will be the time the Contractor is required to complete the removal of traffic control devices required for the road closures according to the time restrictions stated herein and restore traffic to the existing traffic pattern.

The liquidated damages are **Five Thousand Dollars (\$ 5,000.00)** per **(15)** minute time period.

**INTERMEDIATE CONTRACT TIME NUMBER 10 AND LIQUIDATED DAMAGES:**

(2-20-07) (Rev. 10-15-13)

108

SP1 G14 E

The Contractor shall complete the required work of installing, maintaining and removing the traffic control devices for road closures and restoring traffic to the existing traffic pattern. The Contractor shall not close **-L- (Mebane Oaks Rd), -Y1- (I-40/I-85) and/or any Ramp** during the following time restrictions:

DAY AND TIME RESTRICTIONS

**Monday through Sunday from 6:00 AM to 1:00 AM**

The maximum allowable time for **Overhead Sign Installation** is **thirty (30)** minutes for **-L- (Mebane Oaks Rd), -Y1- (I-40/I-85) and any ramp**. The Contractor shall reopen the travel lanes to traffic until any resulting traffic queue is depleted.

The time of availability for this intermediate contract time will be the time the Contractor begins to install traffic control devices required for the road closures according to the time restrictions stated herein.

The completion time for this intermediate contract time will be the time the Contractor is required to complete the removal of traffic control devices required for the road closures according to the time restrictions stated herein and restore traffic to the existing traffic pattern.

The liquidated damages are **Two Thousand Five Hundred Dollars (\$ 2,500.00)** per fifteen **(15)** minute time period.

**INTERMEDIATE CONTRACT TIME NUMBER 11 AND LIQUIDATED DAMAGES:**

(2-20-07) (Rev. 6-18-13)

108

SP1 G14 H

The Contractor shall complete the work required of **Phase IA, Steps #4A thru #4E** as shown on Sheet **TMP-3** and shall place and maintain traffic on same.

The date of availability for this intermediate contract time is the date the Contractor elects to begin the work.

The completion date for this intermediate contract time is the date which is **sixty (60) consecutive calendar days** after and including the date the Contractor begins this work.

The liquidated damages are **One Thousand Dollars (\$ 1,000.00)** per calendar day.

**INTERMEDIATE CONTRACT TIME NUMBER 12 AND LIQUIDATED DAMAGES:**

(2-20-07) (Rev. 6-18-13)

108

SP1 G14 H

The Contractor shall complete the work required of **Phase IC, Steps #1 thru #3** as shown on Sheet **TMP-3** and shall place and maintain traffic on same.

The time of availability for this intermediate contract time is **8:00 PM** the **Friday** the Contractor elects to begin the work.

The completion time for this intermediate contract time is **6:00 AM** the following **Monday**, that is **fifty-eight (58) consecutive hours** after the Contractor begins this work.

The liquidated damages are **One Thousand Two Hundred and Fifty Dollars (\$ 1,250.00)** per fifteen **(15)** minute time period.

**INTERMEDIATE CONTRACT TIME NUMBER 13 AND LIQUIDATED DAMAGES:**

(2-20-07) (Rev. 6-18-13)

108

SP1 G14 H

The Contractor shall complete the work required of **Phase III, Steps #5 thru #7** as shown on Sheet **TMP-3A** and shall place and maintain traffic on same.

The time of availability for this intermediate contract time is **8:00 PM** the **Friday** the Contractor elects to begin the work.

The completion time for this intermediate contract time is **6:00 AM** the following **Monday**, that is **fifty-eight (58) consecutive hours** after the Contractor begins this work.

The liquidated damages are **One Thousand Two Hundred and Fifty Dollars (\$ 1,250.00)** per fifteen **(15)** minute time period.

**INTERMEDIATE CONTRACT TIME NUMBER 14 AND LIQUIDATED DAMAGES FOR FAILURE TO REPAIR A DAMAGED NCDOT ITS FIBER OPTIC COMMUNICATIONS CABLE AND RESTORE COMMUNICATION:**

The Contractor shall repair all existing fiber optic communication cables damaged during construction. The Contractor shall immediately report damages to the Engineer and the NCDOT Regional ITS Engineer at (336) 315-7080. The Contractor shall repair all damages within twenty-four (24) hours at no cost to the Department. The Contractor shall bring all affected ITS fiber optic communication cables back on line within the same twenty-four (24) hours. A “damaged” ITS fiber optic communications cable is any fiber optic communications cable that is determined damaged due to an accidental or unscheduled outage event.

**Liquidated Damages for failure to repair a damaged NCDOT ITS fiber optic communications cable and restore communications within twenty-four (24) hours are Five Hundred Dollars (\$ 500.00) per hour, or any portion thereof.**

**INTERMEDIATE CONTRACT TIME NUMBERS 15 AND 16 AND LIQUIDATED DAMAGES FOR FAILURE TO REESTABLISH ITS FIBER OPTIC COMMUNICATIONS**

During construction, the Contractor shall coordinate any disruption in ITS fiber optic communications with the Engineer and the NCDOT Regional ITS Engineer at (336) 315-7080. The Contractor shall notify the Engineer and the NCDOT Regional ITS Engineer a minimum of seven (7) calendar days prior to all proposed disruptions in service. A minimum of twenty one (21) calendar days prior to any disruption in ITS fiber optic communications, the Contractor shall develop and provide a plan for the Department's approval that defines 1) an anticipated disruption timeframe and 2) a plan of action for reestablishing ITS communications within four (4) hours.

#### **ICT #15**

**Liquidated Damages for failure to reestablish ITS fiber optic communications within four (4) hours are Two Thousand Five Hundred Dollars (\$ 2,500.00) per day, or any portion thereof.**

#### **ICT #16**

**Liquidated Damages for failure to provide a plan that defines 1) an anticipated ITS fiber optic communications disruption timeframe and 2) a plan of action for reestablishing ITS communications a minimum of twenty one (21) calendar days prior to a proposed disruption in service are Ten Thousand Dollars (\$ 10,000.00) per failure.**

#### **PERMANENT VEGETATION ESTABLISHMENT:**

(2-16-12) (Rev. 10-15-13)

104

SP1 G16

Establish a permanent stand of the vegetation mixture shown in the contract. During the period between initial vegetation planting and final project acceptance, perform all work necessary to establish permanent vegetation on all erodible areas within the project limits, as well as, in borrow and waste pits. This work shall include erosion control device maintenance and installation, repair seeding and mulching, supplemental seeding and mulching, mowing, and fertilizer topdressing, as directed. All work shall be performed in accordance with the applicable section of the *2018 Standard Specifications*. All work required for initial vegetation planting shall be performed as a part of the work necessary for the completion and acceptance of the Intermediate Contract Time (ICT). Between the time of ICT and Final Project acceptance, or otherwise referred to as the vegetation establishment period, the Department will be responsible for preparing the required National Pollutant Discharge Elimination System (NPDES) inspection records.

Once the Engineer has determined that the permanent vegetation establishment requirement has been achieved at an 80% vegetation density (the amount of established vegetation per given area to stabilize the soil) and no erodible areas exist within the project limits, the Contractor will be notified to remove the remaining erosion control devices that are no longer needed. The Contractor will be responsible for, and shall correct any areas disturbed by operations performed in permanent vegetation establishment and the removal of temporary erosion control measures, whether occurring prior to or after placing traffic on the project.

Payment for *Response for Erosion Control, Seeding and Mulching, Repair Seeding, Supplemental Seeding, Mowing, Fertilizer Topdressing, Silt Excavation, and Stone for Erosion Control* will be made at contract unit prices for the affected items. Work required that is not represented by contract line items will be paid in accordance with Articles 104-7 or 104-3 of the *2018 Standard Specifications*. No additional compensation will be made for maintenance and removal of temporary erosion control items.

**AWARD OF CONTRACT:**

Revise the 2018 *Standard Specifications* as follows:

**Page 1-23, Subarticle 103-4 (A) General, first paragraph**, replace the 3<sup>rd</sup> and 4<sup>th</sup> sentences with the following:

Where award is to be made, the notice of award will be issued within 60 days after the opening of bids or upon issuance of any necessary debt instrument, whichever is later, but not to exceed 120 days; except with the consent of the lowest responsible bidder the decision to award the contract to such bidder may be delayed for as long a time as may be agreed upon by the Department and such bidder. In the absence of such agreement, the lowest responsible bidder may withdraw his bid at the expiration of 120 days without penalty if no notice of award has been issued.

**DELAY IN RIGHT OF ENTRY:**

(7-1-95) (Rev. 7-15-14)

108

SP1 G22

The Contractor will not be allowed right of entry to the following parcel(s) prior to the listed date(s) unless otherwise permitted by the Engineer.

<b><u>Parcel No.</u></b>	<b><u>Property Owner</u></b>	<b><u>Date</u></b>
009	Calvin Coble	03-15-21
012	E&D Holdings	03-15-21
013	PHD Mebane Oaks	03-15-21
014	Cook Out – Mebane Oaks	03-15-21
016	Restaurant Properties	03-15-21
017	1412-1416 9 <sup>th</sup> Street	03-15-21
018	Twin Creek Properties	03-15-21
019	Mebane Oaks Association	03-15-21
020	Roger Shields	03-15-21
024	Fried Egg, LLC	03-15-21
025	Walmart Real Estate	03-15-21
026	NC Mebane Garrett	03-15-21

**MAJOR CONTRACT ITEMS:**

(2-19-02)

104

SP1 G28

The following listed items are the major contract items for this contract (see Article 104-5 of the *2018 Standard Specifications*):

<b>Line #</b>	<b>Description</b>
29	Asphalt Concrete Base Course, Type B25.0 C
30	Asphalt Concrete Intermediate Course, Type I19.0 C
31	Asphalt Concrete Surface Course, Type S9.5 B
276	Reinforced Concrete Deck Slab

**SPECIALTY ITEMS:**

(7-1-95)(Rev. 1-17-12)

108-6

SP1 G37

Items listed below will be the specialty items for this contract (see Article 108-6 of the 2018 Standard Specifications).

<b>Line #</b>	<b>Description</b>
65-73	Guardrail
74-77, 288	Fencing
80-99	Signing
121-128, 130, 144	Long-Life Pavement Markings
129, 131	Removable Tape
145-146	Permanent Pavement Markers
147-155, 157-160	Lighting
161-181	Utility Construction
182-209	Erosion Control
210-268	Signals/ITS System
271-275	Drilled Piers
296	Polyester Polymer Concrete Materials
299	Placing & Finishing Polyester Polymer Concrete Overlay

**FUEL PRICE ADJUSTMENT:**

(11-15-05) (Rev. 2-18-14)

109-8

SP1 G43

Revise the 2018 Standard Specifications as follows:

**Page 1-87, Article 109-8, Fuel Price Adjustments,** add the following:

The base index price for DIESEL #2 FUEL is \$ **1.6662** per gallon. Where any of the following are included as pay items in the contract, they will be eligible for fuel price adjustment.

The pay items and the fuel factor used in calculating adjustments to be made will be as follows:

<b>Description</b>	<b>Units</b>	<b>Fuel Usage Factor Diesel</b>
Unclassified Excavation	Gal/CY	0.29
Borrow Excavation	Gal/CY	0.29
Class IV Subgrade Stabilization	Gal/Ton	0.55
Aggregate Base Course	Gal/Ton	0.55
Sub-Ballast	Gal/Ton	0.55
Asphalt Concrete Base Course, Type _____	Gal/Ton	2.90
Asphalt Concrete Intermediate Course, Type _____	Gal/Ton	2.90
Asphalt Concrete Surface Course, Type _____	Gal/Ton	2.90
Open-Graded Asphalt Friction Course	Gal/Ton	2.90
Permeable Asphalt Drainage Course, Type _____	Gal/Ton	2.90
Sand Asphalt Surface Course, Type _____	Gal/Ton	2.90
Aggregate for Cement Treated Base Course	Gal/Ton	0.55
Portland Cement for Cement Treated Base Course	Gal/Ton	0.55
" Portland Cement Concrete Pavement	Gal/SY	0.245
Concrete Shoulders Adjacent to ___ " Pavement	Gal/SY	0.245

**SCHEDULE OF ESTIMATED COMPLETION PROGRESS:**

(7-15-08) (Rev. 5-13-19)

108-2

SP1 G58

The Contractor's attention is directed to the Standard Special Provision entitled *Availability of Funds Termination of Contracts* included elsewhere in this proposal. The Department of Transportation's schedule of estimated completion progress for this project as required by that Standard Special Provision is as follows:

<b><u>Fiscal Year</u></b>	<b><u>Progress (% of Dollar Value)</u></b>
2021	(7/01/20 - 6/30/21) 15% of Total Amount Bid
2022	(7/01/21 - 6/30/22) 58% of Total Amount Bid
2023	(7/01/22 - 6/30/23) 26% of Total Amount Bid
2024	(7/01/23 - 6/30/24) 1% of Total Amount Bid

The Contractor shall also furnish his own progress schedule in accordance with Article 108-2 of the *2018 Standard Specifications*. Any acceleration of the progress as shown by the Contractor's progress schedule over the progress as shown above shall be subject to the approval of the Engineer.

**DISADVANTAGED BUSINESS ENTERPRISE:**

(10-16-07)(Rev. 12-17-19)

102-15(J)

SP1 G61

**Description**

The purpose of this Special Provision is to carry out the U.S. Department of Transportation's policy of ensuring nondiscrimination in the award and administration of contracts financed in whole or in part with Federal funds. This provision is guided by 49 CFR Part 26.

**Definitions**

*Additional DBE Subcontractors* - Any DBE submitted at the time of bid that will not be used to meet the DBE goal. No submittal of a Letter of Intent is required.

*Committed DBE Subcontractor* - Any DBE submitted at the time of bid that is being used to meet the DBE goal by submission of a Letter of Intent. Or any DBE used as a replacement for a previously committed DBE firm.

*Contract Goal Requirement* - The approved DBE participation at time of award, but not greater than the advertised contract goal.

*DBE Goal* - A portion of the total contract, expressed as a percentage, that is to be performed by committed DBE subcontractor(s).

*Disadvantaged Business Enterprise (DBE)* - A firm certified as a Disadvantaged Business Enterprise through the North Carolina Unified Certification Program.

*Goal Confirmation Letter* - Written documentation from the Department to the bidder confirming the Contractor's approved, committed DBE participation along with a listing of the committed DBE firms.

*Manufacturer* - A firm that operates or maintains a factory or establishment that produces on the premises, the materials or supplies obtained by the Contractor.

*Regular Dealer* - A firm that owns, operates, or maintains a store, warehouse, or other establishment in which the materials or supplies required for the performance of the contract are bought, kept in stock, and regularly sold to the public in the usual course of business. A regular dealer engages in, as its principal business and in its own name, the purchase and sale or lease of the products in question. A regular dealer in such bulk items as steel, cement, gravel, stone, and petroleum products need not keep such products in stock, if it owns and operates distribution equipment for the products. Brokers and packagers are not regarded as manufacturers or regular dealers within the meaning of this section.

*Replacement / Substitution* – A full or partial reduction in the amount of work subcontracted to a committed (or an approved substitute) DBE firm.

*North Carolina Unified Certification Program (NCUCP)* - A program that provides comprehensive services and information to applicants for DBE certification, such that an applicant is required to apply only once for a DBE certification that will be honored by all recipients of USDOT funds in the state and not limited to the Department of Transportation only. The Certification Program is in accordance with 49 CFR Part 26.

*United States Department of Transportation (USDOT)* - Federal agency responsible for issuing regulations (49 CFR Part 26) and official guidance for the DBE program.

### **Forms and Websites Referenced in this Provision**

*DBE Payment Tracking System* - On-line system in which the Contractor enters the payments made to DBE subcontractors who have performed work on the project.  
<https://apps.dot.state.nc.us/Vendor/PaymentTracking/>

*DBE-IS Subcontractor Payment Information* - Form for reporting the payments made to all DBE firms working on the project. This form is for paper bid projects only.  
<https://connect.ncdot.gov/business/Turnpike/Documents/Form%20DBE-IS%20Subcontractor%20Payment%20Information.pdf>

*RF-1 DBE Replacement Request Form* - Form for replacing a committed DBE.  
<http://connect.ncdot.gov/projects/construction/Construction%20Forms/DBE%20MBE%20WBE%20Replacement%20Request%20Form.pdf>

*SAF Subcontract Approval Form* - Form required for approval to sublet the contract.  
<http://connect.ncdot.gov/projects/construction/Construction%20Forms/Subcontract%20Approval%20Form%20Rev.%202012.zip>

*JC-1 Joint Check Notification Form* - Form and procedures for joint check notification. The form acts as a written joint check agreement among the parties providing full and prompt disclosure of the expected use of joint checks.



<http://connect.ncdot.gov/projects/construction/Construction%20Forms/Joint%20Check%20Notification%20Form.pdf>

*Letter of Intent* - Form signed by the Contractor and the DBE subcontractor, manufacturer or regular dealer that affirms that a portion of said contract is going to be performed by the signed DBE for the estimated amount (based on quantities and unit prices) listed at the time of bid.

<http://connect.ncdot.gov/letting/LetCentral/Letter%20of%20Intent%20to%20Perform%20as%20a%20Subcontractor.pdf>

*Listing of DBE Subcontractors Form* - Form for entering DBE subcontractors on a project that will meet this DBE goal. This form is for paper bids only.

[http://connect.ncdot.gov/municipalities/Bid%20Proposals%20for%20LGA%20Content/08%20DBE%20Subcontractors%20\(Federal\).docx](http://connect.ncdot.gov/municipalities/Bid%20Proposals%20for%20LGA%20Content/08%20DBE%20Subcontractors%20(Federal).docx)

*Subcontractor Quote Comparison Sheet* - Spreadsheet for showing all subcontractor quotes in the work areas where DBEs quoted on the project. This sheet is submitted with good faith effort packages.

<http://connect.ncdot.gov/business/SmallBusiness/Documents/DBE%20Subcontractor%20Quote%20Comparison%20Example.xls>

## **DBE Goal**

The following DBE goal for participation by Disadvantaged Business Enterprises is established for this contract:

Disadvantaged Business Enterprises **5.0** %

- (A) *If the DBE goal is more than zero*, the Contractor shall exercise all necessary and reasonable steps to ensure that DBEs participate in at least the percent of the contract as set forth above as the DBE goal.
- (B) *If the DBE goal is zero*, the Contractor shall make an effort to recruit and use DBEs during the performance of the contract. Any DBE participation obtained shall be reported to the Department.

## **Directory of Transportation Firms (Directory)**

Real-time information is available about firms doing business with the Department and firms that are certified through NCUCP in the Directory of Transportation Firms. Only firms identified in the Directory as DBE certified shall be used to meet the DBE goal. The Directory can be found at the following link. [https:// www.ebs.nc.gov/VendorDirectory/default.html](https://www.ebs.nc.gov/VendorDirectory/default.html)

The listing of an individual firm in the directory shall not be construed as an endorsement of the firm's capability to perform certain work.

### Listing of DBE Subcontractors

At the time of bid, bidders shall submit all DBE participation that they anticipate to use during the life of the contract. Only those identified to meet the DBE goal will be considered committed, even though the listing shall include both committed DBE subcontractors and additional DBE subcontractors. Additional DBE subcontractor participation submitted at the time of bid will be used toward the Department's overall race-neutral goal. Only those firms with current DBE certification at the time of bid opening will be acceptable for listing in the bidder's submittal of DBE participation. The Contractor shall indicate the following required information:

(A) Electronic Bids

Bidders shall submit a listing of DBE participation in the appropriate section of the electronic submittal file.

- (1) Submit the names and addresses of DBE firms identified to participate in the contract. If the bidder uses the updated listing of DBE firms shown in the electronic submittal file, the bidder may use the dropdown menu to access the name and address of the DBE firm.
- (2) Submit the contract line numbers of work to be performed by each DBE firm. When no figures or firms are entered, the bidder will be considered to have no DBE participation.
- (3) The bidder shall be responsible for ensuring that the DBE is certified at the time of bid by checking the Directory of Transportation Firms. If the firm is not certified at the time of the bid-letting, that DBE's participation will not count towards achieving the DBE goal.

(B) Paper Bids

- (1) *If the DBE goal is more than zero,*
  - (a) Bidders, at the time the bid proposal is submitted, shall submit a listing of *DBE* participation, including the names and addresses on *Listing of DBE Subcontractors* contained elsewhere in the contract documents in order for the bid to be considered responsive. Bidders shall indicate the total dollar value of the DBE participation for the contract.
  - (b) If bidders have no DBE participation, they shall indicate this on the *Listing of DBE Subcontractors* by entering the word "None" or the number "0." This form shall be completed in its entirety. **Blank forms will not be deemed to represent zero participation.** Bids submitted that do not have DBE participation indicated on the appropriate form will not be read publicly during the opening of bids. The Department will not consider these bids for award and the proposal will be rejected.

- (c) The bidder shall be responsible for ensuring that the DBE is certified at the time of bid by checking the Directory of Transportation Firms. If the firm is not certified at the time of the bid-letting, that DBE's participation will not count towards achieving the corresponding goal.
- (2) *If the DBE goal is zero, entries on the Listing of DBE Subcontractors are not required for the zero goal, however any DBE participation that is achieved during the project shall be reported in accordance with requirements contained elsewhere in the special provision.*

### **DBE Prime Contractor**

When a certified DBE firm bids on a contract that contains a DBE goal, the DBE firm is responsible for meeting the goal or making good faith efforts to meet the goal, just like any other bidder. In most cases, a DBE bidder on a contract will meet the DBE goal by virtue of the work it performs on the contract with its own forces. However, all the work that is performed by the DBE bidder and any other DBE subcontractors will count toward the DBE goal. The DBE bidder shall list itself along with any DBE subcontractors, if any, in order to receive credit toward the DBE goal.

For example, if the DBE goal is 45% and the DBE bidder will only perform 40% of the contract work, the prime will list itself at 40%, and the additional 5% shall be obtained through additional DBE participation with DBE subcontractors or documented through a good faith effort.

DBE prime contractors shall also follow Sections A and B listed under *Listing of DBE Subcontractor* just as a non-DBE bidder would.

### **Written Documentation – Letter of Intent**

The bidder shall submit written documentation for each DBE that will be used to meet the DBE goal of the contract, indicating the bidder's commitment to use the DBE in the contract. This documentation shall be submitted on the Department's form titled *Letter of Intent*.

The documentation shall be received in the office of the State Contractor Utilization Engineer or at [DBE@ncdot.gov](mailto:DBE@ncdot.gov) no later than 10:00 a.m. of the sixth calendar day following opening of bids, unless the sixth day falls on an official state holiday. In that situation, it is due in the office of the State Contractor Utilization Engineer no later than 10:00 a.m. on the next official state business day.

If the bidder fails to submit the Letter of Intent from each committed DBE to be used toward the DBE goal, or if the form is incomplete (i.e. both signatures are not present), the DBE participation will not count toward meeting the DBE goal. If the lack of this participation drops the commitment below the DBE goal, the Contractor shall submit evidence of good faith efforts, completed in its entirety, to the State Contractor Utilization Engineer or [DBE@ncdot.gov](mailto:DBE@ncdot.gov) no later than 10:00 a.m. on the eighth calendar day following opening of bids, unless the eighth day falls on an official state holiday. In that situation, it is due in the office of the State Contractor Utilization Engineer no later than 10:00 a.m. on the next official state business day.

**Submission of Good Faith Effort**

If the bidder fails to meet or exceed the DBE goal, the apparent lowest responsive bidder shall submit to the Department documentation of adequate good faith efforts made to reach the DBE goal.

A hard copy and an electronic copy of this information shall be received in the office of the State Contractor Utilization Engineer or at DBE@ncdot.gov no later than 10:00 a.m. on the sixth calendar day following opening of bids unless the sixth day falls on an official state holiday. In that situation, it is due in the office of the State Contractor Utilization Engineer no later than 10:00 a.m. on the next official state business day. If the contractor cannot send the information electronically, then one complete set and 5 copies of this information shall be received under the same time constraints above.

Note: Where the information submitted includes repetitious solicitation letters, it will be acceptable to submit a representative letter along with a distribution list of the firms that were solicited. Documentation of DBE quotations shall be a part of the good faith effort submittal. This documentation may include written subcontractor quotations, telephone log notations of verbal quotations, or other types of quotation documentation.

**Consideration of Good Faith Effort for Projects with DBE Goals More Than Zero**

Adequate good faith efforts mean that the bidder took all necessary and reasonable steps to achieve the goal which, by their scope, intensity, and appropriateness, could reasonably be expected to obtain sufficient DBE participation. Adequate good faith efforts also mean that the bidder actively and aggressively sought DBE participation. Mere *pro forma* efforts are not considered good faith efforts.

The Department will consider the quality, quantity, and intensity of the different kinds of efforts a bidder has made. Listed below are examples of the types of actions a bidder will take in making a good faith effort to meet the goal and are not intended to be exclusive or exhaustive, nor is it intended to be a mandatory checklist.

- (A) Soliciting through all reasonable and available means (e.g. attendance at pre-bid meetings, advertising, written notices, use of verifiable electronic means through the use of the NCDOT Directory of Transportation Firms) the interest of all certified DBEs who have the capability to perform the work of the contract. The bidder must solicit this interest within at least 10 days prior to bid opening to allow the DBEs to respond to the solicitation. Solicitation shall provide the opportunity to DBEs within the Division and surrounding Divisions where the project is located. The bidder must determine with certainty if the DBEs are interested by taking appropriate steps to follow up initial solicitations.

- (B) Selecting portions of the work to be performed by DBEs in order to increase the likelihood that the DBE goals will be achieved.
- (1) Where appropriate, break out contract work items into economically feasible units to facilitate DBE participation, even when the prime contractor might otherwise prefer to perform these work items with its own forces.
  - (2) Negotiate with subcontractors to assume part of the responsibility to meet the contract DBE goal when the work to be sublet includes potential for DBE participation (2<sup>nd</sup> and 3<sup>rd</sup> tier subcontractors).
- (C) Providing interested DBEs with adequate information about the plans, specifications, and requirements of the contract in a timely manner to assist them in responding to a solicitation.
- (D) (1) Negotiating in good faith with interested DBEs. It is the bidder's responsibility to make a portion of the work available to DBE subcontractors and suppliers and to select those portions of the work or material needs consistent with the available DBE subcontractors and suppliers, to facilitate DBE participation. Evidence of such negotiation includes the names, addresses, and telephone numbers of DBEs that were considered; a description of the information provided regarding the plans and specifications for the work selected for subcontracting; and evidence as to why additional agreements could not be reached for DBEs to perform the work.
- (2) A bidder using good business judgment would consider a number of factors in negotiating with subcontractors, including DBE subcontractors, and would take a firm's price and capabilities as well as contract goals into consideration. However, the fact that there may be some additional costs involved in finding and using DBEs is not in itself sufficient reason for a bidder's failure to meet the contract DBE goal, as long as such costs are reasonable. Also, the ability or desire of a prime contractor to perform the work of a contract with its own organization does not relieve the bidder of the responsibility to make good faith efforts. Bidding contractors are not, however, required to accept higher quotes from DBEs if the price difference is excessive or unreasonable.
- (E) Not rejecting DBEs as being unqualified without sound reasons based on a thorough investigation of their capabilities. The bidder's standing within its industry, membership in specific groups, organizations, or associates and political or social affiliations (for example, union vs. non-union employee status) are not legitimate causes for the rejection or non-solicitation of bids in the bidder's efforts to meet the project goal.
- (F) Making efforts to assist interested DBEs in obtaining bonding, lines of credit, or insurance as required by the recipient or bidder.
- (G) Making efforts to assist interested DBEs in obtaining necessary equipment, supplies, materials, or related assistance or services.

- (H) Effectively using the services of available minority/women community organizations; minority/women contractors' groups; Federal, State, and local minority/women business assistance offices; and other organizations as allowed on a case-by-case basis to provide assistance in the recruitment and placement of DBEs. Contact within 7 days from the bid opening the Business Opportunity and Work Force Development Unit at BOWD@ncdot.gov to give notification of the bidder's inability to get DBE quotes.
- (I) Any other evidence that the bidder submits which shows that the bidder has made reasonable good faith efforts to meet the DBE goal.

In addition, the Department may take into account the following:

- (1) Whether the bidder's documentation reflects a clear and realistic plan for achieving the DBE goal.
- (2) The bidders' past performance in meeting the DBE goals.
- (3) The performance of other bidders in meeting the DBE goal. For example, when the apparent successful bidder fails to meet the DBE goal, but others meet it, you may reasonably raise the question of whether, with additional reasonable efforts the apparent successful bidder could have met the goal. If the apparent successful bidder fails to meet the DBE goal, but meets or exceeds the average DBE participation obtained by other bidders, the Department may view this, in conjunction with other factors, as evidence of the apparent successful bidder having made a good faith effort.

If the Department does not award the contract to the apparent lowest responsive bidder, the Department reserves the right to award the contract to the next lowest responsive bidder that can satisfy to the Department that the DBE goal can be met or that an adequate good faith effort has been made to meet the DBE goal.

### **Non-Good Faith Appeal**

The State Prequalification Engineer will notify the contractor verbally and in writing of non-good faith. A contractor may appeal a determination of non-good faith made by the Goal Compliance Committee. If a contractor wishes to appeal the determination made by the Committee, they shall provide written notification to the State Prequalification Engineer or at DBE@ncdot.gov. The appeal shall be made within 2 business days of notification of the determination of non-good faith.

### **Counting DBE Participation Toward Meeting DBE Goal**

- (A) Participation

The total dollar value of the participation by a committed DBE will be counted toward the contract goal requirement. The total dollar value of participation by a committed DBE will be based upon the value of work actually performed by the DBE and the actual payments to DBE firms by the Contractor.

## (B) Joint Checks

Prior notification of joint check use shall be required when counting DBE participation for services or purchases that involves the use of a joint check. Notification shall be through submission of Form JC-1 (*Joint Check Notification Form*) and the use of joint checks shall be in accordance with the Department's Joint Check Procedures.

## (C) Subcontracts (Non-Trucking)

A DBE may enter into subcontracts. Work that a DBE subcontracts to another DBE firm may be counted toward the contract goal requirement. Work that a DBE subcontracts to a non-DBE firm does not count toward the contract goal requirement. If a DBE contractor or subcontractor subcontracts a significantly greater portion of the work of the contract than would be expected on the basis of standard industry practices, it shall be presumed that the DBE is not performing a commercially useful function. The DBE may present evidence to rebut this presumption to the Department. The Department's decision on the rebuttal of this presumption is subject to review by the Federal Highway Administration but is not administratively appealable to USDOT.

## (D) Joint Venture

When a DBE performs as a participant in a joint venture, the Contractor may count toward its contract goal requirement a portion of the total value of participation with the DBE in the joint venture, that portion of the total dollar value being a distinct clearly defined portion of work that the DBE performs with its forces.

## (E) Suppliers

A contractor may count toward its DBE requirement 60 percent of its expenditures for materials and supplies required to complete the contract and obtained from a DBE regular dealer and 100 percent of such expenditures from a DBE manufacturer.

## (F) Manufacturers and Regular Dealers

A contractor may count toward its DBE requirement the following expenditures to DBE firms that are not manufacturers or regular dealers:

- (1) The fees or commissions charged by a DBE firm for providing a *bona fide* service, such as professional, technical, consultant, or managerial services, or for providing bonds or insurance specifically required for the performance of a DOT-assisted contract, provided the fees or commissions are determined to be reasonable and not excessive as compared with fees and commissions customarily allowed for similar services.
- (2) With respect to materials or supplies purchased from a DBE, which is neither a manufacturer nor a regular dealer, count the entire amount of fees or commissions charged for assistance in the procurement of the materials and supplies, or fees or transportation charges for the delivery of materials or supplies required on a job site

(but not the cost of the materials and supplies themselves), provided the fees are determined to be reasonable and not excessive as compared with fees customarily allowed for similar services.

### **Commercially Useful Function**

#### **(A) DBE Utilization**

The Contractor may count toward its contract goal requirement only expenditures to DBEs that perform a commercially useful function in the work of a contract. A DBE performs a commercially useful function when it is responsible for execution of the work of the contract and is carrying out its responsibilities by actually performing, managing, and supervising the work involved. To perform a commercially useful function, the DBE shall also be responsible with respect to materials and supplies used on the contract, for negotiating price, determining quality and quantity, ordering the material and installing (where applicable) and paying for the material itself. To determine whether a DBE is performing a commercially useful function, the Department will evaluate the amount of work subcontracted, industry practices, whether the amount the firm is to be paid under the contract is commensurate with the work it is actually performing and the DBE credit claimed for its performance of the work, and any other relevant factors.

#### **(B) DBE Utilization in Trucking**

The following factors will be used to determine if a DBE trucking firm is performing a commercially useful function:

- (1) The DBE shall be responsible for the management and supervision of the entire trucking operation for which it is responsible on a particular contract, and there shall not be a contrived arrangement for the purpose of meeting DBE goals.
- (2) The DBE shall itself own and operate at least one fully licensed, insured, and operational truck used on the contract.
- (3) The DBE receives credit for the total value of the transportation services it provides on the contract using trucks it owns, insures, and operates using drivers it employs.
- (4) The DBE may subcontract the work to another DBE firm, including an owner-operator who is certified as a DBE. The DBE who subcontracts work to another DBE receives credit for the total value of the transportation services the subcontracted DBE provides on the contract.
- (5) The DBE may also subcontract the work to a non-DBE firm, including from an owner-operator. The DBE who subcontracts the work to a non-DBE is entitled to credit for the total value of transportation services provided by the non-DBE subcontractor not to exceed the value of transportation services provided by DBE-owned trucks on the contract. Additional participation by non-DBE subcontractors receives credit only for the fee or commission it receives as a result of the subcontract arrangement. The value of services performed under



subcontract agreements between the DBE and the Contractor will not count towards the DBE contract requirement.

- (6) A DBE may lease truck(s) from an established equipment leasing business open to the general public. The lease must indicate that the DBE has exclusive use of and control over the truck. This requirement does not preclude the leased truck from working for others during the term of the lease with the consent of the DBE, so long as the lease gives the DBE absolute priority for use of the leased truck. This type of lease may count toward the DBE's credit as long as the driver is under the DBE's payroll.
- (7) Subcontracted/leased trucks shall display clearly on the dashboard the name of the DBE that they are subcontracted/leased to and their own company name if it is not identified on the truck itself. Magnetic door signs are not permitted.

### **DBE Replacement**

When a Contractor has relied on a commitment to a DBE subcontractor (or an approved substitute DBE subcontractor) to meet all or part of a contract goal requirement, the contractor shall not terminate the DBE subcontractor for convenience. This includes, but is not limited to, instances in which the Contractor seeks to perform the work of the terminated subcontractor with another DBE subcontractor, a non-DBE subcontractor, or with the Contractor's own forces or those of an affiliate.

The Contractor must give notice in writing both by certified mail and email to the DBE subcontractor, with a copy to the Engineer of its intent to request to terminate and/or substitute, and the reason for the request. The Contractor must give the DBE subcontractor five (5) business days to respond to the Contractor's Notice of Intent to Request Termination and/or Substitution. If the DBE subcontractor objects to the intended termination/substitution, the DBE, within five (5) business days must advise the Contractor and the Department of the reasons why the action should not be approved. The five-day notice period shall begin on the next business day after written notice is provided to the DBE subcontractor.

A committed DBE subcontractor may only be terminated after receiving the Department's written approval based upon a finding of good cause for the proposed termination and/or substitution. For purposes of this section, good cause shall include the following circumstances:

- (a) The listed DBE subcontractor fails or refuses to execute a written contract;
- (b) The listed DBE subcontractor fails or refuses to perform the work of its subcontract in a way consistent with normal industry standards. Provided, however, that good cause does not exist if the failure or refusal of the DBE subcontractor to perform its work on the subcontract results from the bad faith or discriminatory action of the prime contractor;
- (c) The listed DBE subcontractor fails or refuses to meet the prime contractor's reasonable, nondiscriminatory bond requirements;
- (d) The listed DBE subcontractor becomes bankrupt, insolvent, or exhibits credit unworthiness;

- (e) The listed DBE subcontractor is ineligible to work on public works projects because of suspension and debarment proceedings pursuant to 2 CFR Parts 180, 215 and 1,200 or applicable state law;
- (f) The listed DBE subcontractor is not a responsible contractor;
- (g) The listed DBE voluntarily withdraws from the project and provides written notice of withdrawal;
- (h) The listed DBE is ineligible to receive DBE credit for the type of work required;
- (i) A DBE owner dies or becomes disabled with the result that the listed DBE contractor is unable to complete its work on the contract;
- (j) Other documented good cause that compels the termination of the DBE subcontractor. Provided, that good cause does not exist if the prime contractor seeks to terminate a DBE it relied upon to obtain the contract so that the prime contractor can self-perform the work for which the DBE contractor was engaged or so that the prime contractor can substitute another DBE or non-DBE contractor after contract award.

The Contractor shall comply with the following for replacement of a committed DBE:

(A) Performance Related Replacement

When a committed DBE is terminated for good cause as stated above, an additional DBE that was submitted at the time of bid may be used to fulfill the DBE commitment. A good faith effort will only be required for removing a committed DBE if there were no additional DBEs submitted at the time of bid to cover the same amount of work as the DBE that was terminated.

If a replacement DBE is not found that can perform at least the same amount of work as the terminated DBE, the Contractor shall submit a good faith effort documenting the steps taken. Such documentation shall include, but not be limited to, the following:

- (1) Copies of written notification to DBEs that their interest is solicited in contracting the work defaulted by the previous DBE or in subcontracting other items of work in the contract.
- (2) Efforts to negotiate with DBEs for specific subbids including, at a minimum:
  - (a) The names, addresses, and telephone numbers of DBEs who were contacted.
  - (b) A description of the information provided to DBEs regarding the plans and specifications for portions of the work to be performed.
- (3) A list of reasons why DBE quotes were not accepted.
- (4) Efforts made to assist the DBEs contacted, if needed, in obtaining bonding or insurance required by the Contractor.

**(B) Decertification Replacement**

- (1) When a committed DBE is decertified by the Department after the SAF (*Subcontract Approval Form*) has been received by the Department, the Department will not require the Contractor to solicit replacement DBE participation equal to the remaining work to be performed by the decertified firm. The participation equal to the remaining work performed by the decertified firm will count toward the contract goal requirement.
- (2) When a committed DBE is decertified prior to the Department receiving the SAF (*Subcontract Approval Form*) for the named DBE firm, the Contractor shall take all necessary and reasonable steps to replace the DBE subcontractor with another DBE subcontractor to perform at least the same amount of work to meet the DBE goal requirement. If a DBE firm is not found to do the same amount of work, a good faith effort must be submitted to NCDOT (see A herein for required documentation).

All requests for replacement of a committed DBE firm shall be submitted to the Engineer for approval on Form RF-1 (*DBE Replacement Request*). If the Contractor fails to follow this procedure, the Contractor may be disqualified from further bidding for a period of up to 6 months.

**Changes in the Work**

When the Engineer makes changes that result in the reduction or elimination of work to be performed by a committed DBE, the Contractor will not be required to seek additional participation. When the Engineer makes changes that result in additional work to be performed by a DBE based upon the Contractor's commitment, the DBE shall participate in additional work to the same extent as the DBE participated in the original contract work.

When the Engineer makes changes that result in extra work, which has more than a minimal impact on the contract amount, the Contractor shall seek additional participation by DBEs unless otherwise approved by the Engineer.

When the Engineer makes changes that result in an alteration of plans or details of construction, and a portion or all of the work had been expected to be performed by a committed DBE, the Contractor shall seek participation by DBEs unless otherwise approved by the Engineer.

When the Contractor requests changes in the work that result in the reduction or elimination of work that the Contractor committed to be performed by a DBE, the Contractor shall seek additional participation by DBEs equal to the reduced DBE participation caused by the changes.

**Reports and Documentation**

A SAF (*Subcontract Approval Form*) shall be submitted for all work which is to be performed by a DBE subcontractor. The Department reserves the right to require copies of actual subcontract agreements involving DBE subcontractors.

When using transportation services to meet the contract commitment, the Contractor shall submit a proposed trucking plan in addition to the SAF. The plan shall be submitted prior to beginning construction on the project. The plan shall include the names of all trucking firms proposed for use, their certification type(s), the number of trucks owned by the firm, as well as the individual truck identification numbers, and the line item(s) being performed.

Within 30 calendar days of entering into an agreement with a DBE for materials, supplies or services, not otherwise documented by the SAF as specified above, the Contractor shall furnish the Engineer a copy of the agreement. The documentation shall also indicate the percentage (60% or 100%) of expenditures claimed for DBE credit.

### **Reporting Disadvantaged Business Enterprise Participation**

The Contractor shall provide the Engineer with an accounting of payments made to all DBE firms, including material suppliers and contractors at all levels (prime, subcontractor, or second tier subcontractor). This accounting shall be furnished to the Engineer for any given month by the end of the following month. Failure to submit this information accordingly may result in the following action:

- (A) Withholding of money due in the next partial pay estimate; or
- (B) Removal of an approved contractor from the prequalified bidders' list or the removal of other entities from the approved subcontractors list.

While each contractor (prime, subcontractor, 2nd tier subcontractor) is responsible for accurate accounting of payments to DBEs, it shall be the prime contractor's responsibility to report all monthly and final payment information in the correct reporting manner.

Failure on the part of the Contractor to submit the required information in the time frame specified may result in the disqualification of that contractor and any affiliate companies from further bidding until the required information is submitted.

Failure on the part of any subcontractor to submit the required information in the time frame specified may result in the disqualification of that contractor and any affiliate companies from being approved for work on future DOT projects until the required information is submitted.

Contractors reporting transportation services provided by non-DBE lessees shall evaluate the value of services provided during the month of the reporting period only.

At any time, the Engineer can request written verification of subcontractor payments.

The Contractor shall report the accounting of payments through the Department's DBE Payment Tracking System.

**Failure to Meet Contract Requirements**

Failure to meet contract requirements in accordance with Subarticle 102-15(J) of the *2018 Standard Specifications* may be cause to disqualify the Contractor.

**CERTIFICATION FOR FEDERAL-AID CONTRACTS:**

(3-21-90)

SP1 G85

The prospective participant certifies, by signing and submitting this bid or proposal, to the best of his or her knowledge and belief, that:

- (A) No Federal appropriated funds have been paid or will be paid, by or on behalf of the undersigned, to any person for influencing or attempting to influence an officer or employee of any Federal agency, a Member of Congress, an officer or employee of Congress, or an employee of a Member of Congress in connection with the awarding of any Federal contract, the making of any Federal grant, the making of any Federal loan, the entering into of any cooperative agreement, and the extension, continuation, renewal, amendment, or modification of any Federal contract, grant, loan, or cooperative agreement.
- (B) If any funds other than Federal appropriated funds have been paid or will be paid to any person for influencing or attempting to influence an officer or employee of any Federal agency, a Member of Congress, an officer or employee of Congress, or an employee of a Member of Congress in connection with this Federal contract, grant, loan, or cooperative agreement, the undersigned shall complete and submit Standard Form-LLL, *Disclosure Form to Report Lobbying*, in accordance with its instructions.

This certification is a material representation of fact upon which reliance was placed when this transaction was made or entered into. Submission of this certification is a prerequisite for making or entering into this transaction imposed by *Section 1352, Title 31, U.S. Code*. Any person who fails to file the required certification shall be subject to a civil penalty of not less than \$10,000 and not more than \$100,000 for each such failure.

The prospective participant also agrees by submitting his or her bid or proposal that he or she shall require that the language of this certification be included in all lower tier subcontracts, which exceed \$100,000 and that all such subrecipients shall certify and disclose accordingly.

**CONTRACTOR'S LICENSE REQUIREMENTS:**

(7-1-95)

102-14

SP1 G88

If the successful bidder does not hold the proper license to perform any plumbing, heating, air conditioning, or electrical work in this contract, he will be required to sublet such work to a contractor properly licensed in accordance with *Article 2 of Chapter 87 of the General Statutes* (licensing of heating, plumbing, and air conditioning contractors) and *Article 4 of Chapter 87 of the General Statutes* (licensing of electrical contractors).

**RESTRICTIONS ON ITS EQUIPMENT AND SERVICES:**

(11-17-20)

SP01 G090

All telecommunications, video or other ITS equipment or services installed or utilized on this project must be in conformance with UNIFORM ADMINISTRATIVE REQUIREMENTS, COST

**PRINCIPLES, AND AUDIT REQUIREMENTS FOR FEDERAL AWARDS 2 CFR, § 200.216  
Prohibition on certain telecommunications and video surveillance services or equipment.**

**USE OF UNMANNED AIRCRAFT SYSTEM (UAS):**

(8-20-19)

SP1 G092

The Contractor shall adhere to all Federal, State and Local regulations and guidelines for the use of Unmanned Aircraft Systems (UAS). This includes but is not limited to US 14 CFR Part 107 *Small UAS Rule*, NC GS 15A-300.2 *Regulation of launch and recovery sites*, NC GS 63-95 *Training required for the operation of unmanned aircraft systems*, NC GS 63-96 *Permit required for commercial operation of unmanned aircraft system*, and NCDOT UAS Policy. The required operator certifications include possessing a current Federal Aviation Administration (FAA) Remote Pilot Certificate, a NC UAS Operator Permit as well as operating a UAS registered with the FAA.

Prior to beginning operations, the Contractor shall complete the NCDOT UAS – Flight Operation Approval Form and submit it to the Engineer for approval. All UAS operations shall be approved by the Engineer prior to beginning the operations.

All contractors or subcontractors operating UAS shall have UAS specific general liability insurance to cover all operations under this contract.

The use of UAS is at the Contractor's discretion. No measurement or payment will be made for the use of UAS. In the event that the Department directs the Contractor to utilize UAS, payment will be in accordance with Article 104-7 Extra Work.

**EQUIPMENT IDLING GUIDELINES:**

(1-19-21)

107

SP1 G096

Exercise reduced fuel consumption and reduced equipment emissions during the construction of all work associated with this contract. Employees engaged in the construction of this project should turn off vehicles when stopped for more than thirty (30) minutes and off-highway equipment should idle no longer than fifteen (15) consecutive minutes.

These guidelines for turning off vehicles and equipment when idling do not apply to:

1. Idling when queuing.
2. Idling to verify the vehicle is in safe operating condition.
3. Idling for testing, servicing, repairing or diagnostic purposes.
4. Idling necessary to accomplish work for which the vehicle was designed (such as operating a crane, mixing concrete, etc.).
5. Idling required to bring the machine system to operating temperature.
6. Emergency vehicles, utility company, construction, and maintenance vehicles where the engines must run to perform needed work.
7. Idling to ensure safe operation of the vehicle.
8. Idling when the propulsion engine is providing auxiliary power for other than heating or air conditioning. (such as hydraulic systems for pavers)
9. When specific traffic, safety, or emergency situations arise.

10. If the ambient temperature is less than 32 degrees Fahrenheit. Limited idling to provide for the safety of vehicle occupants (e.g. to run the heater).
  11. If the ambient temperature is greater than 90 degrees Fahrenheit. Limited idling to provide for the safety of vehicle occupants of off-highway equipment (e.g. to run the air conditioning) no more than 30 minutes.
  12. Diesel powered vehicles may idle for up to 30 minutes to minimize restart problems.
- Any vehicle, truck, or equipment in which the primary source of fuel is natural gas or electricity is exempt from the idling limitations set forth in this special provision.

**U.S. DEPARTMENT OF TRANSPORTATION HOTLINE:**

(11-22-94)

108-5

SP1 G100

To report bid rigging activities call: **1-800-424-9071**

The U.S. Department of Transportation (DOT) operates the above toll-free hotline Monday through Friday, 8:00 a.m. to 5:00 p.m. eastern time. Anyone with knowledge of possible bid rigging, bidder collusion, or other fraudulent activities should use the hotline to report such activities.

The hotline is part of the DOT's continuing effort to identify and investigate highway construction contract fraud and abuse is operated under the direction of the DOT Inspector General. All information will be treated confidentially and caller anonymity will be respected.

**CARGO PREFERENCE ACT:**

(2-16-16)

Privately owned United States-flag commercial vessels transporting cargoes are subject to the Cargo Preference Act (CPA) of 1954 requirements and regulations found in 46 CFR 381.7. Contractors are directed to clause (b) of 46 CFR 381.7 as follows:

- (b) Contractor and Subcontractor Clauses. "Use of United States-flag vessels: The contractor agrees-

" (1) To utilize privately owned United States-flag commercial vessels to ship at least 50 percent of the gross tonnage (computed separately for dry bulk carriers, dry cargo liners, and tankers) involved, whenever shipping any equipment, material, or commodities pursuant to this contract, to the extent such vessels are available at fair and reasonable rates for United States-flag commercial vessels.

(2) To furnish within 20 days following the date of loading for shipments originating within the United States or within 30 working days following the date of loading for shipments originating outside the United States a legible copy of a rated, 'on-board' commercial ocean bill-of-lading in English for each shipment of cargo described in paragraph (b) (1) of this section to both the Contracting Officer (through the prime contractor in the case of subcontractor bills-of-lading) and to the Division of National Cargo, Office of Market Development, Maritime Administration, Washington, DC 20590.

(3) To insert the substance of the provisions of this clause in all subcontracts issued pursuant to this contract."

**SUBSURFACE INFORMATION:**

(7-1-95)

450

SP1 G112 C

Subsurface information is available on the roadway and structure portions of this project.

**PORTABLE CONCRETE BARRIER - (Partial Payments for Materials):**

(7-1-95) (Rev. 8-16-11)

1170-4

SP1 G121

When so authorized by the Engineer, partial materials payments will be made up to 95 percent of the delivered cost of portable concrete barrier, provided that these materials have been delivered on the project and stored in an acceptable manner, and further provided the documents listed in Subarticle 109-5(C) of the *2018 Standard Specifications* have been furnished to the Engineer.

The provisions of Subarticle 109-5(B) of the *2018 Standard Specifications* will apply to the portable concrete barrier.

**MAINTENANCE OF THE PROJECT:**

(11-20-07) (Rev. 1-17-12)

104-10

SP1 G125

Revise the *2018 Standard Specifications* as follows:

**Page 1-39, Article 104-10 Maintenance of the Project, line 25,** add the following after the first sentence of the first paragraph:

All guardrail/guiderail within the project limits shall be included in this maintenance.

**Page 1-39, Article 104-10 Maintenance of the Project, line 30,** add the following as the last sentence of the first paragraph:

The Contractor shall perform weekly inspections of guardrail and guiderail and shall report damages to the Engineer on the same day of the weekly inspection. *Where damaged guardrail or guiderail is repaired or replaced as a result of maintaining the project in accordance with this article, such repair or replacement shall be performed within 7 consecutive calendar days of such inspection report.*

**Page 1-39, Article 104-10 Maintenance of the Project, lines 42-44,** replace the last sentence of the last paragraph with the following:

The Contractor will not be directly compensated for any maintenance operations necessary, except for maintenance of guardrail/guiderail, as this work will be considered incidental to the work covered by the various contract items. The provisions of Article 104-7, Extra Work, and Article 104-8, Compensation and Record Keeping will apply to authorized maintenance of guardrail/guiderail. Performance of weekly inspections of guardrail/guiderail, and the damage reports required as described above, will be considered to be an incidental part of the work being paid for by the various contract items.



**ELECTRONIC BIDDING:**

(2-19-19)

101, 102, 103

SP1 G140

Revise the *2018 Standard Specifications* as follows:

**Page 1-4, Article 101-3, DEFINITIONS, BID (OR PROPOSAL) *Electronic Bid*, line 1,** replace “Bid Express®” with “the approved electronic bidding provider”.

**Page 1-15, Subarticle 102-8(B), Electronic Bids, lines 39-40,** replace “to Bid Express®” with “via the approved electronic bidding provider”.

**Page 1-15, Subarticle 102-8(B)(1), Electronic Bids, line 41,** delete “from Bid Express®”

**Page 1-17, Subarticle 102-9(C)(2), Electronic Bids, line 21,** replace “Bid Express® miscellaneous folder within the .ebs” with “electronic submittal”.

**Page 1-29, Subarticle 103-4(C)(2), Electronic Bids, line 32,** replace “.ebs miscellaneous data file of Expedite” with “electronic submittal file”

**TWELVE MONTH GUARANTEE:**

(7-15-03)

108

SP1 G145

- (A) The Contractor shall guarantee materials and workmanship against latent and patent defects arising from faulty materials, faulty workmanship or negligence for a period of twelve months following the date of final acceptance of the work for maintenance and shall replace such defective materials and workmanship without cost to the Department. The Contractor will not be responsible for damage due to faulty design, normal wear and tear, for negligence on the part of the Department, and/or for use in excess of the design.
- (B) Where items of equipment or material carry a manufacturer’s guarantee for any period in excess of twelve months, then the manufacturer’s guarantee shall apply for that particular piece of equipment or material. The Department’s first remedy shall be through the manufacturer although the Contractor is responsible for invoking the warranted repair work with the manufacturer. The Contractor’s responsibility shall be limited to the term of the manufacturer’s guarantee. NCDOT would be afforded the same warranty as provided by the Manufacturer.

This guarantee provision shall be invoked only for major components of work in which the Contractor would be wholly responsible for under the terms of the contract. Examples would include pavement structures, bridge components, and sign structures. This provision will not be used as a mechanism to force the Contractor to return to the project to make repairs or perform additional work that the Department would normally compensate the Contractor for. In addition, routine maintenance activities (i.e. mowing grass, debris removal, ruts in earth shoulders,) are not parts of this guarantee.

Appropriate provisions of the payment and/or performance bonds shall cover this guarantee for the project.

To ensure uniform application statewide the Division Engineer will forward details regarding the circumstances surrounding any proposed guarantee repairs to the Chief Engineer for review and approval prior to the work being performed.

**EROSION AND SEDIMENT CONTROL/STORMWATER CERTIFICATION:**

(1-16-07) (Rev 12-15-20)

105-16, 225-2, 16

SP1 G180

**General**

Schedule and conduct construction activities in a manner that will minimize soil erosion and the resulting sedimentation and turbidity of surface waters. Comply with the requirements herein regardless of whether or not a National Pollution discharge Elimination System (NPDES) permit for the work is required.

Establish a chain of responsibility for operations and subcontractors' operations to ensure that the *Erosion and Sediment Control/Stormwater Pollution Prevention Plan* is implemented and maintained over the life of the contract.

- (A) *Certified Supervisor* - Provide a certified Erosion and Sediment Control/Stormwater Supervisor to manage the Contractor and subcontractor operations, insure compliance with Federal, State and Local ordinances and regulations, and manage the Quality Control Program.
- (B) *Certified Foreman* - Provide a certified, trained foreman for each construction operation that increases the potential for soil erosion or the possible sedimentation and turbidity of surface waters.
- (C) *Certified Installer* - Provide a certified installer to install or direct the installation for erosion or sediment/stormwater control practices.
- (D) *Certified Designer* - Provide a certified designer for the design of the erosion and sediment control/stormwater component of reclamation plans and, if applicable, for the design of the project erosion and sediment control/stormwater plan.

**Roles and Responsibilities**

- (A) *Certified Erosion and Sediment Control/Stormwater Supervisor* - The Certified Supervisor shall be Level II and responsible for ensuring the erosion and sediment control/stormwater plan is adequately implemented and maintained on the project and for conducting the quality control program. The Certified Supervisor shall be on the project within 24 hours notice from initial exposure of an erodible surface to the project's final acceptance. Perform the following duties:
  - (1) *Manage Operations* - Coordinate and schedule the work of subcontractors so that erosion and sediment control/stormwater measures are fully executed for each operation and in a timely manner over the duration of the contract.

- (a) Oversee the work of subcontractors so that appropriate erosion and sediment control/stormwater preventive measures are conformed to at each stage of the work.
  - (b) Prepare the required National Pollutant Discharge Elimination System (NPDES) Inspection Record and submit to the Engineer.
  - (c) Attend all weekly or monthly construction meetings to discuss the findings of the NPDES inspection and other related issues.
  - (d) Implement the erosion and sediment control/stormwater site plans requested.
  - (e) Provide any needed erosion and sediment control/stormwater practices for the Contractor's temporary work not shown on the plans, such as, but not limited to work platforms, temporary construction, pumping operations, plant and storage yards, and cofferdams.
  - (f) Acquire applicable permits and comply with requirements for borrow pits, dewatering, and any temporary work conducted by the Contractor in jurisdictional areas.
  - (g) Conduct all erosion and sediment control/stormwater work in a timely and workmanlike manner.
  - (h) Fully perform and install erosion and sediment control/stormwater work prior to any suspension of the work.
  - (i) Coordinate with Department, Federal, State and Local Regulatory agencies on resolution of erosion and sediment control/stormwater issues due to the Contractor's operations.
  - (j) Ensure that proper cleanup occurs from vehicle tracking on paved surfaces or any location where sediment leaves the Right-of-Way.
  - (k) Have available a set of erosion and sediment control/stormwater plans that are initialed and include the installation date of Best Management Practices. These practices shall include temporary and permanent groundcover and be properly updated to reflect necessary plan and field changes for use and review by Department personnel as well as regulatory agencies.
- (2) Requirements set forth under the NPDES Permit - The Department's NPDES Stormwater permit (NCS000250) outlines certain objectives and management measures pertaining to construction activities. The permit references *NCG010000, General Permit to Discharge Stormwater* under the NPDES, and states that the Department shall incorporate the applicable requirements into its delegated Erosion and Sediment Control Program for construction activities disturbing one or more acres of land. The Department further incorporates these requirements on all contracted bridge and culvert work at jurisdictional waters, regardless of size. Some of the requirements are, but are not limited to:
- (a) Control project site waste to prevent contamination of surface or ground waters of the state, i.e. from equipment operation/maintenance, construction materials, concrete washout, chemicals, litter, fuels, lubricants, coolants, hydraulic fluids, any other petroleum products, and sanitary waste.
  - (b) Inspect erosion and sediment control/stormwater devices and stormwater discharge outfalls at least once every 7 calendar days and within 24 hours after a rainfall event equal to or greater than 1.0 inch that occurs within a 24

- hour period. Additional monitoring may be required at the discretion of Division of Water Resources personnel if the receiving stream is 303(d) listed for turbidity and the project has had documented problems managing turbidity.
- (c) Maintain an onsite rain gauge or use the Department's Multi-Sensor Precipitation Estimate website to maintain a daily record of rainfall amounts and dates.
  - (d) Maintain erosion and sediment control/stormwater inspection records for review by Department and Regulatory personnel upon request.
  - (e) Implement approved reclamation plans on all borrow pits, waste sites and staging areas.
  - (f) Maintain a log of turbidity test results as outlined in the Department's Procedure for Monitoring Borrow Pit Discharge.
  - (g) Provide secondary containment for bulk storage of liquid materials.
  - (h) Provide training for employees concerning general erosion and sediment control/stormwater awareness, the Department's NPDES Stormwater Permit NCS000250 requirements, and the applicable requirements of the *General Permit, NCG010000*.
  - (i) Report violations of the NPDES permit to the Engineer immediately who will notify the Division of Water Quality Regional Office within 24 hours of becoming aware of the violation.
- (3) Quality Control Program - Maintain a quality control program to control erosion, prevent sedimentation and follow provisions/conditions of permits. The quality control program shall:
- (a) Follow permit requirements related to the Contractor and subcontractors' construction activities.
  - (b) Ensure that all operators and subcontractors on site have the proper erosion and sediment control/stormwater certification.
  - (c) Notify the Engineer when the required certified erosion and sediment control/stormwater personnel are not available on the job site when needed.
  - (d) Conduct the inspections required by the NPDES permit.
  - (e) Take corrective actions in the proper timeframe as required by the NPDES permit for problem areas identified during the NPDES inspections.
  - (f) Incorporate erosion control into the work in a timely manner and stabilize disturbed areas with mulch/seed or vegetative cover on a section-by-section basis.
  - (g) Use flocculants approved by state regulatory authorities where appropriate and where required for turbidity and sedimentation reduction.
  - (h) Ensure proper installation and maintenance of temporary erosion and sediment control devices.
  - (i) Remove temporary erosion or sediment control devices when they are no longer necessary as agreed upon by the Engineer.
  - (j) The Contractor's quality control and inspection procedures shall be subject to review by the Engineer. Maintain NPDES inspection records and make records available at all times for verification by the Engineer.

(B) *Certified Foreman* - At least one Certified Foreman shall be onsite for each type of work listed herein during the respective construction activities to control erosion, prevent sedimentation and follow permit provisions:

- (1) Foreman in charge of grading activities
- (2) Foreman in charge of bridge or culvert construction over jurisdictional areas
- (3) Foreman in charge of utility activities

The Contractor may request to use the same person as the Level II Supervisor and Level II Foreman. This person shall be onsite whenever construction activities as described above are taking place. This request shall be approved by the Engineer prior to work beginning.

The Contractor may request to name a single Level II Foreman to oversee multiple construction activities on small bridge or culvert replacement projects. This request shall be approved by the Engineer prior to work beginning.

(C) *Certified Installers* - Provide at least one onsite, Level I Certified Installer for each of the following erosion and sediment control/stormwater crew:

- (1) Seeding and Mulching
- (2) Temporary Seeding
- (3) Temporary Mulching
- (4) Sodding
- (5) Silt fence or other perimeter erosion/sediment control device installations
- (6) Erosion control blanket installation
- (7) Hydraulic tackifier installation
- (8) Turbidity curtain installation
- (9) Rock ditch check/sediment dam installation
- (10) Ditch liner/matting installation
- (11) Inlet protection
- (12) Riprap placement
- (13) Stormwater BMP installations (such as but not limited to level spreaders, retention/detention devices)
- (14) Pipe installations within jurisdictional areas

If a Level I *Certified Installer* is not onsite, the Contractor may substitute a Level II Foreman for a Level I Installer, provided the Level II Foreman is not tasked to another crew requiring Level II Foreman oversight.

(D) *Certified Designer* - Include the certification number of the Level III Certified Designer on the erosion and sediment control/stormwater component of all reclamation plans and if applicable, the certification number of the Level III Certified Designer on the design of the project erosion and sediment control/stormwater plan.

**Preconstruction Meeting**

Furnish the names of the *Certified Erosion and Sediment Control/Stormwater Supervisor*, *Certified Foremen*, *Certified Installers* and *Certified Designer* and notify the Engineer of changes in certified personnel over the life of the contract within 2 days of change.

**Ethical Responsibility**

Any company performing work for the North Carolina Department of Transportation has the ethical responsibility to fully disclose any reprimand or dismissal of an employee resulting from improper testing or falsification of records.

**Revocation or Suspension of Certification**

Upon recommendation of the Chief Engineer to the certification entity, certification for *Supervisor*, *Certified Foremen*, *Certified Installers* and *Certified Designer* may be revoked or suspended with the issuance of an *Immediate Corrective Action (ICA)*, *Notice of Violation (NOV)*, or *Cease and Desist Order* for erosion and sediment control/stormwater related issues.

The Chief Engineer may recommend suspension or permanent revocation of certification due to the following:

- (A) Failure to adequately perform the duties as defined within this certification provision.
- (B) Issuance of an ICA, NOV, or Cease and Desist Order.
- (C) Failure to fully perform environmental commitments as detailed within the permit conditions and specifications.
- (D) Demonstration of erroneous documentation or reporting techniques.
- (E) Cheating or copying another candidate's work on an examination.
- (F) Intentional falsification of records.
- (G) Directing a subordinate under direct or indirect supervision to perform any of the above actions.
- (H) Dismissal from a company for any of the above reasons.
- (I) Suspension or revocation of one's certification by another entity.

Suspension or revocation of a certification will be sent by certified mail to the certificant and the Corporate Head of the company that employs the certificant.

A certificant has the right to appeal any adverse action which results in suspension or permanent revocation of certification by responding, in writing, to the Chief Engineer within 10 calendar days after receiving notice of the proposed adverse action.

Chief Engineer  
1536 Mail Service Center  
Raleigh, NC 27699-1536

Failure to appeal within 10 calendar days will result in the proposed adverse action becoming effective on the date specified on the certified notice. Failure to appeal within the time specified

will result in a waiver of all future appeal rights regarding the adverse action taken. The certificant will not be allowed to perform duties associated with the certification during the appeal process.

The Chief Engineer will hear the appeal and make a decision within 7 days of hearing the appeal. Decision of the Chief Engineer will be final and will be made in writing to the certificant.

If a certification is temporarily suspended, the certificant shall pass any applicable written examination and any proficiency examination, at the conclusion of the specified suspension period, prior to having the certification reinstated.

### **Measurement and Payment**

*Certified Erosion and Sediment Control/Stormwater Supervisor, Certified Foremen, Certified Installers and Certified Designer* will be incidental to the project for which no direct compensation will be made.

### **PROCEDURE FOR MONITORING BORROW PIT DISCHARGE:**

(2-20-07) (Rev. 4-5-19)

105-16, 230, 801

SP1 G181

Water discharge from borrow pit sites shall not cause surface waters to exceed 50 NTUs (nephelometric turbidity unit) in streams not designated as trout waters and 10 NTUs in streams, lakes or reservoirs designated as trout waters. For lakes and reservoirs not designated as trout waters, the turbidity shall not exceed 25 NTUs. If the turbidity exceeds these levels due to natural background conditions, the existing turbidity level shall not be increased.

If during any operating day, the downstream water quality exceeds the standard, the Contractor shall do all of the following:

- (A) Either cease discharge or modify the discharge volume or turbidity levels to bring the downstream turbidity levels into compliance, or
- (B) Evaluate the upstream conditions to determine if the exceedance of the standard is due to natural background conditions. If the background turbidity measurements exceed the standard, operation of the pit and discharge can continue as long as the stream turbidity levels are not increased due to the discharge.
- (C) Measure and record the turbidity test results (time, date and sampler) at all defined sampling locations 30 minutes after startup and at a minimum, one additional sampling of all sampling locations during that 24-hour period in which the borrow pit is discharging.
- (D) Notify DWQ within 24 hours of any stream turbidity standard exceedances that are not brought into compliance.

During the Environmental Assessment required by Article 230-4 of the *2018 Standard Specifications*, the Contractor shall define the point at which the discharge enters into the State's surface waters and the appropriate sampling locations. Sampling locations shall include points upstream and downstream from the point at which the discharge enters these waters. Upstream sampling location shall be located so that it is not influenced by backwater conditions and

represents natural background conditions. Downstream sampling location shall be located at the point where complete mixing of the discharge and receiving water has occurred.

The discharge shall be closely monitored when water from the dewatering activities is introduced into jurisdictional wetlands. Any time visible sedimentation (deposition of sediment) on the wetland surface is observed, the dewatering activity will be suspended until turbidity levels in the stilling basin can be reduced to a level where sediment deposition does not occur. Staining of wetland surfaces from suspended clay particles, occurring after evaporation or infiltration, does not constitute sedimentation. No activities shall occur in wetlands that adversely affect the functioning of a wetland. Visible sedimentation will be considered an indication of possible adverse impacts on wetland use.

The Engineer will perform independent turbidity tests on a random basis. These results will be maintained in a log within the project records. Records will include, at a minimum, turbidity test results, time, date and name of sampler. Should the Department's test results exceed those of the Contractor's test results, an immediate test shall be performed jointly with the results superseding the previous test results of both the Department and the Contractor.

The Contractor shall use the *NCDOT Turbidity Reduction Options for Borrow Pits Matrix*, available at <https://connect.ncdot.gov/resources/roadside/FieldOperationsDocuments/TurbidityReductionOptionSheet.pdf> to plan, design, construct, and maintain BMPs to address water quality standards. Tier I Methods include stilling basins which are standard compensatory BMPs. Other Tier I methods are noncompensatory and shall be used when needed to meet the stream turbidity standards. Tier II Methods are also noncompensatory and are options that may be needed for protection of rare or unique resources or where special environmental conditions exist at the site which have led to additional requirements being placed in the DWQ's 401 Certifications and approval letters, Isolated Wetland Permits, Riparian Buffer Authorization or a DOT Reclamation Plan's Environmental Assessment for the specific site. Should the Contractor exhaust all Tier I Methods on a site exclusive of rare or unique resources or special environmental conditions, Tier II Methods may be required by regulators on a case by case basis per supplemental agreement.

The Contractor may use cation exchange capacity (CEC) values from proposed site borings to plan and develop the bid for the project. CEC values exceeding 15 milliequivalents per 100 grams of soil may indicate a high potential for turbidity and should be avoided when dewatering into surface water is proposed.

No additional compensation for monitoring borrow pit discharge will be paid.



**PROJECT SPECIAL PROVISIONS****ROADWAY****CLEARING AND GRUBBING - METHOD II:**

(9-17-02) (Rev.8-18-15)

200

SP2 R02A

Perform clearing on this project to the limits established by Method "II" shown on Standard Drawing No. 200.02 of the *2018 Roadway Standard Drawings*. Conventional clearing methods may be used except where permit drawings or conditions have been included in the proposal which require certain areas to be cleared by hand methods.

**BURNING RESTRICTIONS:**

(7-1-95)

200, 210, 215

SP2 R05

Open burning is not permitted on any portion of the right-of-way limits established for this project. Do not burn the clearing, grubbing or demolition debris designated for disposal and generated from the project at locations within the project limits, off the project limits or at any waste or borrow sites in this county. Dispose of the clearing, grubbing and demolition debris by means other than burning, according to state or local rules and regulations.

**SHOULDER AND FILL SLOPE MATERIAL:**

(5-21-02)

235, 560

SP2 R45 A

**Description**

Perform the required shoulder and slope construction for this project in accordance with the applicable requirements of Section 560 and Section 235 of the *2018 Standard Specifications*.

**Measurement and Payment**

Where the material has been obtained from an authorized stockpile or from a borrow source and *Borrow Excavation* is not included in the contract, no direct payment will be made for this work, as the cost of this work will be part of the work being paid at the contract lump sum price for *Grading*. If *Borrow Excavation* is included in this contract and the material has been obtained from an authorized stockpile or from a borrow source, measurement and payment will be as provided in Section 230 of the *2018 Standard Specifications* for *Borrow Excavation*.

**MANUFACTURED QUARRY FINES IN EMBANKMENTS:**

(01-17-17)

235

SP02 R72

**Description**

This specification addresses the use of manufactured quarry fines that are not classified as select materials. The specification allows the Contractor an option, with the approval of the Engineer, to use manufactured quarry fines (MQFs) in embankments as a substitute for conventional borrow material. Furnish and place geotextile for pavement stabilization in accordance with the Geotextile for Pavement Stabilization special provision and detail. Geotextile for pavement stabilization is required to prevent pavement cracking and provide separation between the subgrade and pavement section at embankment locations where manufactured quarry fines are utilized and as directed by the Engineer.

**Materials**

Manufactured Quarry Fines.

Site specific approval of MQFs material will be required prior to beginning construction as detailed in the preconstruction requirements of this provision.

The following MQFs are unacceptable:

- (A) Frozen material,
- (B) Material with a maximum dry unit weight of less than 90 pounds per cubic foot when tested in accordance with AASHTO T-99 Method A or C.
- (C) Material with greater than 80% by weight Passing the #200 sieve

Collect and transport MQFs in a manner that will prevent nuisances and hazards to public health and safety. Moisture condition the MQFs as needed and transport in covered trucks to prevent dusting. If MQFs are blended with natural earth material, follow Borrow Criteria in Section 1018 of the *Standard Specifications*.

**Geotextiles**

Areas of embankment where MQFs are incorporated, Geotextile for Pavement Stabilization shall be used. If the Geotextile for Pavement Stabilization special provision is not included elsewhere in this contract, then it along with a detail will be incorporated as part of the contractors request to use. Notification of subgrade elevation, sampling and waiting period as required in the Construction Methods section of the Geotextile for Pavement Stabilization special provision are not required.

**Preconstruction Requirements**

When MQFs are to be used as a substitute for earth borrow material, request written approval from the Engineer at least ninety (90) days in advance of the intent to use MQFs and include the following details:

- (A) Description, purpose and location of project.
- (B) Estimated start and completion dates of project.
- (C) Estimated volume of MQFs to be used on project with specific locations and construction details of the placement.
- (D) The names, address, and contact information for the generator of the MQFs.
- (E) Physical location of the site at which the MQFs were generated.

The Engineer will forward this information to the State Materials Engineer for review and material approval.

**Construction Methods**

Place MQFs in the core of the embankment section with at least 4 feet of earth cover to the outside limits of the embankments or subgrade.

Construct embankments by placing MQFs in level uniform lifts with no more than a lift of 10 inches and compacted to at least a density of 95 percent as determined by test methods in AASHTO T-99, Determination of Maximum Dry Density and Optimum Moisture Content,

Method A or C depending upon particle size of the product. Provide a moisture content at the time of compaction of within 4 percent of optimum but not greater than one percent above optimum as determined by AASHTO T-99, Method A or C.

Areas of embankment where MQFs are incorporated, Geotextile for Pavement Stabilization shall be used. See Geotextile for Pavement Stabilization special provision for geotextile type and construction method.

### Measurement and Payment

*Borrow Excavation* will be measured by truck volume and paid in cubic yards in accordance with Article 230-5 of the *2018 Standard Specifications*. As an alternate weigh tickets can be provided and payment made by converting weight to cubic yards based on the verifiable unit weight. Where the pay item for *Borrow Excavation* is not included in the original contract then no separate payment will be made for this item and payment will be included in the lump sum price bid for *Grading*.

Where the pay item of *Geotextile for Pavement Stabilization* is included in the original contract the material will be measured and paid in square yards (see Geotextile for Pavement Stabilization special provision). Where the pay item of *Geotextile for Pavement Stabilization* is not included in the original contract then no payment will be made for this item and will be considered incidental to the use of MQFs in embankment.

### **POLYPROPYLENE CULVERT PIPE:**

(8-20-19)

305,310

SP3 R35

Revise the *2018 Standard Specifications* as follows:

**Page 3-5, Article 305-1 DESCRIPTION**, lines 12-14, replace with the following:

Where shown in the plans, the Contractor may use reinforced concrete pipe, aluminum alloy pipe, aluminized corrugated steel pipe, HDPE pipe, Polypropylene Pipe, or PVC pipe in accordance with the following requirements.

**Page 3-5, Article 305-2 MATERIALS**, add the following after line 16:

<b>Item</b>	<b>Section</b>
Polypropylene Pipe	1032-9

**Page 3-6, Article 310-2 MATERIALS**, add the following after line 9:

<b>Item</b>	<b>Section</b>
Polypropylene Pipe	1032-9

**Page 3-6, Article 310-4 SIDE DRAIN PIPE**, lines 24-25, replace the first sentence of the second paragraph with the following:

Where shown in the plans, side drain pipe may be Class II reinforced concrete pipe, aluminized corrugated steel pipe, corrugated aluminum alloy pipe, polypropylene pipe, HDPE pipe or PVC

pipe.

**Page 3-7, Article 310-5 PIPE END SECTIONS**, lines 2-4, replace the second sentence with the following:

Both corrugated steel and concrete pipe end sections will work on concrete pipe, corrugated steel pipe, polypropylene pipe, and HDPE smooth lined corrugated plastic pipe.

**Page 3-7, Article 310-6 MEASUREMENT AND PAYMENT**, add the following after line 14:

<b>Pay Item</b>	<b>Pay Unit</b>
__" Polypropylene Pipe	Linear Foot

**Page 10-60, add Article 1032-9:**

**(A) General**

Use polypropylene pipe from sources participating in the Department's Polypropylene Pipe QA/QC Program. A list of participating sources is available from the Materials and Tests Unit. The Department will remove a manufacturer of polypropylene pipe from this program if the monitoring efforts indicated that non-specification material is being provided or test procedures are not being followed.

Use polypropylene culvert pipe that meets AASHTO M 330 for Type S or Type D, or ASTM F2881 or ASTM F2764 Double or Triple wall; and has been evaluated by NTPEP.

**(B) End Treatments, Pipe Tees and Elbows**

End treatments, pipe tees and elbows shall meet AASHTO M 330, Section 7.7, or ASTM F2764, Section 6.6.

**(C) Marking**

Clearly mark each section of pipe, end section, tee and elbow and other accessories according to the Department's Polypropylene Pipe QC/QA Program:

- (1) AASHTO or ASTM Designation
- (2) The date of manufacture
- (3) Name or trademark of the manufacturer

When polypropylene pipe, end sections, tees and elbows have been inspected and accepted a sticker will be applied to the inside of the pipe. Do not use pipe sections, flared end sections, tees or elbows which do not have this seal of approval.

**BRIDGE APPROACH FILLS:**

(10-19-10) (Rev. 1-16-18)

422

SP4 R02A

**Description**

Bridge approach fills consist of backfilling behind bridge end bents with select material or aggregate to support all or portions of bridge approach slabs. Install drains to drain water from bridge approach fills and geotextiles to separate approach fills from embankment fills, ABC and natural ground as required. For bridge approach fills behind end bents with mechanically stabilized earth (MSE) abutment walls, reinforce bridge approach fills with MSE wall reinforcement connected to end bent caps. Construct bridge approach fills in accordance with the contract, accepted submittals and 2018 Roadway Standard Drawing Nos. 422.01 or 422.02 or Roadway Detail Drawing No. 422D10.

Define bridge approach fill types as follows:

*Approach Fills* – Bridge approach fills in accordance with 2018 Roadway Standard Drawing Nos. 422.01 or 422.02 or Roadway Detail Drawing No. 422D10;

*Standard Approach Fill* – Type I Standard Bridge Approach Fill in accordance with 2018 Roadway Standard Drawing No. 422.01;

*Modified Approach Fill* – Type II Modified Bridge Approach Fill in accordance with 2018 Roadway Standard Drawing No. 422.02 and

*Reinforced Approach Fill* – Type III Reinforced Bridge Approach Fill in accordance with Roadway Detail Drawing No. 422D10.

**Materials**

Refer to Division 10 of the *2018 Standard Specifications*.

<b>Item</b>	<b>Section</b>
Geotextiles, Type 1	1056
Portland Cement Concrete	1000
Select Materials	1016
Subsurface Drainage Materials	1044

Provide Type 1 geotextile for separation geotextiles and Class B concrete for outlet pads. Use Class V or Class VI select material for standard and modified approach fills. For an approach fill behind a bridge end bent with an MSE abutment wall, backfill the reinforced approach fill with the same aggregate type approved for the reinforced zone in the accepted MSE wall submittal. For MSE wall aggregate, reinforcement and connector materials, see the *Mechanically Stabilized Earth Retaining Walls* provision. Provide PVC pipes, fittings and outlet pipes for subsurface drainage materials. For PVC drain pipes, use pipes with perforations that meet AASHTO M 278.

## Construction Methods

Excavate as necessary for approach fills in accordance with the contract. Notify the Engineer when foundation excavation is complete. Do not place separation geotextiles or aggregate until approach fill dimensions and foundation material are approved.

For reinforced approach fills, cast MSE wall reinforcement or connectors into end bent cap backwalls within 3" of locations shown in the accepted MSE wall submittals. Install MSE wall reinforcement with the orientation, dimensions and number of layers shown in the accepted MSE wall submittals. If a reinforced approach fill is designed with geogrid reinforcement embedded in an end bent cap, cut geogrids to the required lengths and after securing ends of geogrids in place, reroll and rewrap portions of geogrids not embedded in the cap to protect geogrids from damage. Before placing aggregate, pull geosynthetic reinforcement taut so that it is in tension and free of kinks, folds, wrinkles or creases.

Attach separation geotextiles to end bent cap backwalls and wing walls with adhesives, tapes or other approved methods. Overlap adjacent separation geotextiles at least 18" with seams oriented parallel to the roadway centerline. Hold geotextiles in place with wire staples or anchor pins as needed. Contact the Engineer when existing or future obstructions such as foundations, pavements, pipes, inlets or utilities will interfere with separation geotextiles or MSE wall reinforcement.

Install continuous perforated PVC drain pipes with perforations pointing down in accordance with 2018 Roadway Standard Drawing Nos. 422.01 or 422.02. Connect drain pipes to outlet pipes just beyond wing walls. Connect PVC pipes, fittings and outlet pipes with solvent cement in accordance with Article 815-3 of the *2018 Standard Specifications* and place outlet pads in accordance with 2018 Roadway Standard Drawing No. 815.03.

Install drain pipes so water drains towards outlets. If the groundwater elevation is above drain pipe elevations, raise drains up to maintain positive drainage towards outlets. Place pipe sleeves in or under wing walls so water drains towards outlets. Use sleeves that can withstand wing wall loads.

Place select material or aggregate in 8" to 10" thick lifts. Compact fine aggregate for reinforced approach fills in accordance with Subarticle 235-3(C) of the *2018 Standard Specifications* except compact fine aggregate to a density of at least 98%. Compact select material for standard or modified approach fills and coarse aggregate for reinforced approach fills with a vibratory compactor to the satisfaction of the Engineer. Do not displace or damage geosynthetics, MSE wall reinforcement or drains when placing and compacting select material or aggregate. End dumping directly on geosynthetics is not permitted. Do not operate heavy equipment on geosynthetics or drain pipes until they are covered with at least 8" of select material or aggregate. Replace any damaged geosynthetics or drains to the satisfaction of the Engineer. When approach fills extend beyond bridge approach slabs, wrap separation geotextiles over select material or aggregate as shown in 2018 Roadway Standard Drawing No. 422.01 or 2018 Roadway Detail Drawing No. 422D10.

**Measurement and Payment**

*Type I Standard Approach Fill, Station \_\_\_\_\_, Type II Modified Approach Fill, Station \_\_\_\_\_ and Type III Reinforced Approach Fill, Station \_\_\_\_\_* will be paid at the contract lump sum price. The lump sum price for each approach fill will be full compensation for providing labor, tools, equipment and approach fill materials, excavating, backfilling, hauling and removing excavated materials, installing geotextiles and drains, compacting backfill and supplying select material, aggregate, separation geotextiles, drain pipes, pipe sleeves, outlet pipes and pads and any incidentals necessary to construct approach fills behind bridge end bents.

The contract lump sum price for *Type III Reinforced Approach Fill, Station \_\_\_\_\_* will also be full compensation for supplying and connecting MSE wall reinforcement to end bent caps but not designing MSE wall reinforcement and connectors. The cost of designing reinforcement and connectors for reinforced approach fills behind bridge end bents with MSE abutment walls will be incidental to the contract unit price for *MSE Retaining Wall No. \_\_\_\_*.

Payment will be made under:

<b>Pay Item</b>	<b>Pay Unit</b>
Type I Standard Approach Fill, Station _____	Lump Sum
Type II Modified Approach Fill, Station _____	Lump Sum
Type III Reinforced Approach Fill, Station _____	Lump Sum

**PRICE ADJUSTMENT - ASPHALT BINDER FOR PLANT MIX:**

(11-21-00)

620

SP6 R25

Price adjustments for asphalt binder for plant mix will be made in accordance with Section 620 of the *2018 Standard Specifications*.

The base price index for asphalt binder for plant mix is \$ **430.00** per ton.

This base price index represents an average of F.O.B. selling prices of asphalt binder at supplier's terminals on **February 1, 2021**.

**FINAL SURFACE TESTING NOT REQUIRED:**

(5-18-04) (Rev. 2-16-16)

610

SP6 R45

Final surface testing is not required on this project in accordance with Section 610-13, *Final Surface Testing and Acceptance*.

**MILLING ASPHALT PAVEMENT:**

(1-15-19)

607

SP6 R59

Revise the *2018 Standard Specifications* as follows:

**Page 6-5, Article 607-2, EQUIPMENT, lines 14-16**, delete the seventh sentence of this Article and replace with the following:

Use either a non-contacting laser or sonar type ski system with a minimum of three referencing stations mounted on the milling machine at a length of at least 24 feet.

**ASPHALT CONCRETE PLANT MIX PAVEMENTS:**

(2-20-18) (Rev.1-15-19)

610, 1012

SP6 R65

Revise the *2018 Standard Specifications* as follows:

**Page 6-14, Table 609-3, LIMITS OF PRECISION FOR TEST RESULTS**, replace with the following:

<b>TABLE 609-3 LIMITS OF PRECISION FOR TEST RESULTS</b>	
<b>Mix Property</b>	<b>Limits of Precision</b>
25.0 mm sieve (Base Mix)	± 10.0%
19.0 mm sieve (Base Mix)	± 10.0%
12.5 mm sieve (Intermediate & Type P-57)	± 6.0%
9.5 mm sieve (Surface Mix)	± 5.0%
4.75 mm sieve (Surface Mix)	± 5.0%
2.36 mm sieve (All Mixes, except S4.75A)	± 5.0%
1.18 mm sieve (S4.75A)	± 5.0%
0.075 mm sieve (All Mixes)	± 2.0%
Asphalt Binder Content	± 0.5%
Maximum Specific Gravity ( $G_{mm}$ )	± 0.020
Bulk Specific Gravity ( $G_{mb}$ )	± 0.030
TSR	± 15.0%
QA retest of prepared QC Gyratory Compacted Volumetric Specimens	± 0.015
Retest of QC Core Sample	± 1.2% (% Compaction)
Comparison QA Core Sample	± 2.0% (% Compaction)
QA Verification Core Sample	± 2.0% (% Compaction)
Density Gauge Comparison of QC Test	± 2.0% (% Compaction)
QA Density Gauge Verification Test	± 2.0% (% Compaction)

**Page 6-17, Table 610-1, MIXING TEMPERATURE AT THE ASPHALT PLANT**, replace with the following:

<b>TABLE 610-1 MIXING TEMPERATURE AT THE ASPHALT PLANT</b>	
<b>Binder Grade</b>	<b>JMF Temperature</b>
PG 58-28; PG 64-22	250 - 290°F
PG 76-22	300 - 325°F

**Page 6-17, Subarticle 610-3(C), Job Mix Formula (JMF), lines 38-39**, delete the fourth paragraph.

**Page 6-18, Subarticle 610-3(C), Job Mix Formula (JMF), line 12**, replace “SF9.5A” with “S9.5B”.

**Page 6-18, Table 610-3, MIX DESIGN CRITERIA**, replace with the following:



**TABLE 610-3  
MIX DESIGN CRITERIA**

Mix Type	Design ESALs millions <sup>A</sup>	Binder PG Grade	Compaction Levels		Max. Rut Depth (mm)	Volumetric Properties <sup>B</sup>			
			G <sub>mm</sub> @			VMA	VTM	VFA	%G <sub>mm</sub>
			N <sub>ini</sub>	N <sub>des</sub>		% Min.	%	Min.-Max.	@ N <sub>ini</sub>
S4.75A	< 1	64 - 22	6	50	11.5	16.0	4.0 - 6.0	65 - 80	≤ 91.5
S9.5B	0 - 3	64 - 22	6	50	9.5	16.0	3.0 - 5.0	70 - 80	≤ 91.5
S9.5C	3 - 30	64 - 22	7	65	6.5	15.5	3.0 - 5.0	65 - 78	≤ 90.5
S9.5D	> 30	76 - 22	8	100	4.5	15.5	3.0 - 5.0	65 - 78	≤ 90.0
I19.0C	ALL	64 - 22	7	65	-	13.5	3.0 - 5.0	65 - 78	≤ 90.5
B25.0C	ALL	64 - 22	7	65	-	12.5	3.0 - 5.0	65 - 78	≤ 90.5
<b>Design Parameter</b>						<b>Design Criteria</b>			
All Mix Types	Dust to Binder Ratio (P <sub>0.075</sub> / P <sub>be</sub> )					0.6 - 1.4 <sup>C</sup>			
	Tensile Strength Ratio (TSR) <sup>D</sup>					85% Min. <sup>E</sup>			

- A. Based on 20 year design traffic.
- B. Volumetric Properties based on specimens compacted to N<sub>des</sub> as modified by the Department.
- C. Dust to Binder Ratio (P<sub>0.075</sub> / P<sub>be</sub>) for Type S4.75A is 1.0 - 2.0.
- D. NCDOT-T-283 (No Freeze-Thaw cycle required).
- E. TSR for Type S4.75A & B25.0C mixes is 80% minimum.

Page 6-19, Table 610-5, BINDER GRADE REQUIREMENTS (BASED ON RBR%), replace with the following:

**TABLE 610-5  
BINDER GRADE REQUIREMENTS (BASED ON RBR%)**

Mix Type	%RBR ≤ 20%	21% ≤ %RBR ≤ 30%	%RBR ≥ 30%
S4.75A, S9.5B, S9.5C, I19.0C, B25.0C	PG 64-22	PG 64-22 <sup>A</sup>	PG-58-28
S9.5D, OGFC	PG 76-22 <sup>B</sup>	n/a	n/a

- A. If the mix contains any amount of RAS, the virgin binder shall be PG 58-28.
- B. Maximum Recycled Binder Replacement (%RBR) is 18% for mixes using PG 76-22 binder.

Page 6-20, Table 610-6, PLACEMENT TEMPERATURES FOR ASPHALT, replace with the following:

**TABLE 610-6  
PLACEMENT TEMPERATURES FOR ASPHALT**

Asphalt Concrete Mix Type	Minimum Surface and Air Temperature
B25.0C	35°F
I19.0C	35°F
S4.75A, S9.5B, S9.5C	40°F <sup>A</sup>
S9.5D	50°F

- A. For the final layer of surface mixes containing recycled asphalt shingles (RAS), the minimum surface and air temperature shall be 50°F.

Page 6-21, Article 610-8, SPREADING AND FINISHING, lines 34-35, delete the second sentence and replace with the following:

Use an MTV for all surface mix regardless of binder grade on Interstate, US Routes, and NC Routes (primary routes) that have 4 or more lanes and median divided.

**Page 6-21, Article 610-8, SPREADING AND FINISHING, lines 36-38,** delete the fourth sentence and replace with the following:

Use MTV for all ramps, loops, Y-line that have 4 or more lanes and are median divided, full width acceleration lanes, full width deceleration lanes, and full width turn lanes that are greater than 1000 feet in length.

**Page 6-23, Table 610-7, DENSITY REQUIREMENTS,** replace with the following:

<b>Mix Type</b>	<b>Minimum % G<sub>mm</sub> (Maximum Specific Gravity)</b>
S4.75A	85.0 <sup>A</sup>
S9.5B	90.0
S9.5C, S9.5D, I19.0C, B25.0C	92.0

A. Compaction to the above specified density will be required when the S4.75A mix is applied at a rate of 100 lbs/sy or higher.

**Page 6-24, Article 610-13, FINAL SURFACE TESTING, lines 35-36,** delete the second sentence and replace with the following:

Final surface testing is not required on ramps, loops and turn lanes.

**Page 6-26, Subarticle 610-13(A)(1), Acceptance for New Construction, lines 29-30,** delete the second sentence and replace with the following:

Areas excluded from testing by the profiler may be tested using a 10-foot straightedge in accordance with Article 610-12.

**Page 6-27, Subarticle 610-13(B), Option 2- North Carolina Hearne Straightedge, lines 41-46,** delete the eighth and ninth sentence of this paragraph and replace with the following:

Take profiles over the entire length of the final surface travel lane pavement exclusive of structures, approach slabs, paved shoulders, tapers, or other irregular shaped areas of pavement, unless otherwise approved by the Engineer. Test in accordance with this provision all mainline travel lanes, full width acceleration or deceleration lanes and collector lanes.

**Page 6-28, Subarticle 610-13(B), Option 2- North Carolina Hearne Straightedge, lines 1-2,** delete these two lines.

**Page 6-32, Article 610-16 MEASUREMENT AND PAYMENT,** replace with the following:

<b>Pay Item</b>	<b>Pay Unit</b>
Asphalt Concrete Base Course, Type B25.0C	Ton
Asphalt Concrete Intermediate Course, Type I19.0C	Ton
Asphalt Concrete Surface Course, Type S4.75A	Ton
Asphalt Concrete Surface Course, Type S9.5B	Ton

Asphalt Concrete Surface Course, Type S9.5C  
 Asphalt Concrete Surface Course, Type S9.5D

Ton  
 Ton

Page 10-30, Table 1012-1, AGGREGATE CONSENSUS PROPERTIES, replace with the following:

**TABLE 1012-1  
 AGGREGATE CONSENSUS PROPERTIES<sup>A</sup>**

<b>Mix Type</b>	<b>Coarse Aggregate Angularity<sup>B</sup></b>	<b>Fine Aggregate Angularity % Minimum</b>	<b>Sand Equivalent % Minimum</b>	<b>Flat and Elongated 5 : 1 Ratio % Maximum</b>
<i>Test Method</i>	<i>ASTM D5821</i>	<i>AASHTO T 304</i>	<i>AASHTO T 176</i>	<i>ASTM D4791</i>
S4.75A; S9.5B	75 / -	40	40	-
S9.5C; I19.0C; B25.0C	95 / 90	45	45	10
S9.5D	100 / 100	45	50	10
OGFC	100 / 100	45	45	10
UBWC	100 / 85	45	45	10

A. Requirements apply to the design aggregate blend.

B. 95 / 90 denotes that 95% of the coarse aggregate has one fractured face and 90% has 2 or more fractured faces.

## **AUTOMATED MACHINE GUIDANCE**

(1-2-11)

801

SP8 R01

### **General**

This Special Provision contains requirements to be followed if the Contractor elects to use Global Positioning System (GPS) machine control grading and shall be used in conjunction with Section 801 of the *Standard Specifications*. The use of this technology is referenced as Automated Machine Guidance (AMG).

All equipment using AMG shall be able to generate end results that meet the *Standard Specifications*. Perform test sections for each type of work to be completed with AMG to demonstrate that the system has the capability to achieve acceptable results. If acceptable results cannot be achieved, conform to the requirements for conventional stakeout.

The Contractor shall be responsible for all errors resulting from the use of AMG and shall correct deficiencies to the satisfaction of the Engineer at no cost to the Department.

### **Submittals**

If the Contractor elects to use AMG, a Digital Terrain Model (DTM) of the design surface and all intermediate surfaces shall be developed and submitted to the Engineer for review.

At least 90 days prior to beginning grading operations, the Contractor shall submit to the Engineer an AMG work plan to include, but not limited to, proposed equipment, control software manufacturer and version, types of work to be completed using AMG, project site calibration report, repetitive calibration methods for construction equipment and rover units to be used for the duration of the project, and local GPS base station to be used for broadcasting differential correction data to rover units (this may include the NC Network RTK). All surveys must be tied to existing project control as established by NCDOT.

### **Inspection**

The Engineer will perform quality assurance checks of all work associated with AMG. If it is determined that work is not being performed in a manner that will assure accurate results, the Engineer may require corrective action at no cost to the Department.

The Contractor shall provide the Engineer with one GPS rover unit for use during the duration of the contract. The rover will be loaded with the same model that is used with the AMG and have the same capability as rover units used by the Contractor. The rover will be kept in the possession of the Engineer and will be returned to the Contractor upon completion of the contract. Any maintenance or repairs required for the rover will be the responsibility of the Contractor. Formal training of at least 8 hours shall be provided to the Engineer by the Contractor on the use of the proposed AMG system.

### **Subgrade and Base Controls**

If the Contractor elects to use AMG for fine grading and placement of base or other roadway materials, the GPS shall be supplemented with a laser or robotic total station. Include details of the proposed system in the AMG work plan. In addition, the following requirements apply for the use of AMG for subgrade and base construction.

Provide control points at intervals along the project not to exceed 1,000 feet. The horizontal position of these points shall be determined by static GPS sessions or by traverse connection from the original base line control points. The elevation of these control points shall be established using differential leveling from project benchmarks, forming closed loops where practical. A copy of all new control point information shall be provided to the Engineer prior to construction activities.

Provide control points and conventional survey grade stakes at 500 foot intervals and at critical points such as, but not limited to, PCs, PTs, superelevation transition points, and other critical points as requested by the Engineer.

Provide hubs at the top of the finished subgrade at all hinge points on the cross section at 500 foot intervals. These hubs shall be established using conventional survey methods for use by the Engineer to check the accuracy of construction.

### **Measurement and Payment**

No direct payment will be made for work required to utilize this provision. All work will be considered incidental to various grading operations.

**GUARDRAIL END UNITS, TYPE - TL-3:**

(4-20-04) (Rev. 7-1-17)

862

SP8 R65

**Description**

Furnish and install guardrail end units in accordance with the details in the plans, the applicable requirements of Section 862 of the *2018 Standard Specifications*, and at locations shown in the plans.

**Materials**

Furnish guardrail end units listed on the NCDOT [Approved Products List](https://apps.dot.state.nc.us/vendor/approvedproducts/) at <https://apps.dot.state.nc.us/vendor/approvedproducts/> or approved equal.

Prior to installation the Contractor shall submit to the Engineer:

- (A) FHWA acceptance letter for each guardrail end unit certifying it meets the requirements of the AASHTO Manual for Assessing Safety Hardware, Test Level 3, in accordance with Article 106-2 of the *2018 Standard Specifications*.
- (B) Certified working drawings and assembling instructions from the manufacturer for each guardrail end unit in accordance with Article 105-2 of the *2018 Standard Specifications*.

No modifications shall be made to the guardrail end unit without the express written permission from the manufacturer. Perform installation in accordance with the details in the plans, and details and assembling instructions furnished by the manufacturer.

**Construction Methods**

Guardrail end delineation is required on all approach and trailing end sections for both temporary and permanent installations. Guardrail end delineation consists of yellow reflective sheeting applied to the entire end section of the guardrail in accordance with Article 1088-3 of the *2018 Standard Specifications* and is incidental to the cost of the guardrail end unit.

**Measurement and Payment**

Measurement and payment will be made in accordance with Article 862-6 of the *2018 Standard Specifications*.

Payment will be made under:

**Pay Item**

Guardrail End Units, Type TL-3

**Pay Unit**

Each

**GUARDRAIL ANCHOR UNITS AND TEMPORARY GUARDRAIL ANCHOR UNITS:**

(1-16-2018)

862

SP8 R70

Guardrail anchor units will be in accordance with the details in the plans and the applicable requirements of Section 862 of the *2018 Standard Specifications*.

Revise the *2018 Standard Specifications* as follows:

**Page 8-42, Article 862-6 MEASUREMENT AND PAYMENT**, add the following:

*Guardrail Anchor Units, Type \_\_\_ and Temporary Guardrail Anchor Units Type \_\_\_* will be measured and paid as units of each completed and accepted. No separate measurement will be made of any rail, terminal sections, posts, offset blocks, concrete, hardware or any other components of the completed unit that are within the pay limits shown in the plans for the unit as all such components will be considered to be part of the unit.

Payment will be made under:

<b>Pay Item</b>	<b>Pay Unit</b>
Guardrail Anchor Units, Type _____	Each
Temporary Guardrail Anchor Units, Type _____	Each

**STEEL PIPE HANDRAIL:****Description**

Furnish and install steel pipe handrail at the location shown in the plans, in accordance with the detail in the plans and as directed by the Engineer.

**Measurement and Payment**

*Steel Pipe Handrail* will be measured and paid for as the actual number of linear feet of steel pipe handrail measured along the top of the handrail to the nearest 0.1 of a foot. Such price and payment shall be full compensation for fabricating, furnishing, installing, painting and all incidentals necessary to satisfactorily install the handrail.

Payment will be made under:

<b>Pay Item</b>	<b>Pay Unit</b>
Steel Pipe Handrail	Linear Feet

**FOUNDATIONS AND ANCHOR ROD ASSEMBLIES FOR METAL POLES:**

(1-17-12) (Rev. 1-16-18)

9, 14, 17

SP9 R05

**Description**

Foundations for metal poles include foundations for signals, cameras, overhead and dynamic message signs (DMS) and high mount and light standards supported by metal poles or upright trusses. Foundations consist of footings with pedestals and drilled piers with or without grade

beams or wings. Anchor rod assemblies consist of anchor rods (also called anchor bolts) with nuts and washers on the exposed ends of rods and nuts and a plate or washers on the other ends of rods embedded in the foundation.

Construct concrete foundations with the required resistances and dimensions and install anchor rod assemblies in accordance with the contract and accepted submittals. Construct drilled piers consisting of cast-in-place reinforced concrete cylindrical sections in excavated holes. Provide temporary casings or polymer slurry as needed to stabilize drilled pier excavations. Use a prequalified Drilled Pier Contractor to construct drilled piers for metal poles. Define “excavation” and “hole” as a drilled pier excavation and “pier” as a drilled pier.

This provision does not apply to foundations for signal pedestals; see Section 1743 of the *2018 Standard Specifications* and 2018 Roadway Standard Drawing No. 1743.01.

### **Materials**

Refer to the *2018 Standard Specifications*.

<b>Item</b>	<b>Section</b>
Conduit	1091-3
Grout, Type 2	1003
Polymer Slurry	411-2(B)(2)
Portland Cement Concrete	1000
Reinforcing Steel	1070
Rollers and Chairs	411-2(C)
Temporary Casings	411-2(A)

Provide Type 3 material certifications in accordance with Article 106-3 of the *2018 Standard Specifications* for conduit, rollers, chairs and anchor rod assemblies. Store steel materials on blocking at least 12" above the ground and protect it at all times from damage; and when placing in the work make sure it is free from dirt, dust, loose mill scale, loose rust, paint, oil or other foreign materials. Load, transport, unload and store foundation and anchor rod assembly materials so materials are kept clean and free of damage. Bent, damaged or defective materials will be rejected.

Use conduit type in accordance with the contract. Use Class A concrete for footings and pedestals, Class Drilled Pier concrete for drilled piers and Class AA concrete for grade beams and wings including portions of drilled piers above bottom of wings elevations. Corrugated temporary casings may be accepted at the discretion of the Engineer. A list of approved polymer slurry products is available from:

[connect.ncdot.gov/resources/Geological/Pages/Products.aspx](http://connect.ncdot.gov/resources/Geological/Pages/Products.aspx)

Provide anchor rod assemblies in accordance with the contract consisting of the following:

- (A) Straight anchor rods,
- (B) Heavy hex top and leveling nuts and flat washers on exposed ends of rods, and

- (C) Nuts and either flat plates or washers on the other ends of anchor rods embedded in foundations.

Do not use lock washers. Use steel anchor rods, nuts and washers that meet ASTM F1554 for Grade 55 rods and Grade A nuts. Use steel plates and washers embedded in concrete with a thickness of at least 1/4". Galvanize anchor rods and exposed nuts and washers in accordance with Article 1076-4 of the *2018 Standard Specifications*. It is not necessary to galvanize nuts, plates and washers embedded in concrete.

### **Construction Methods**

Install the required size and number of conduits in foundations in accordance with the plans and accepted submittals. Construct top of piers, footings, pedestals, grade beams and wings flat, level and within 1" of elevations shown in the plans or approved by the Engineer. Provide an Ordinary Surface finish in accordance with Subarticle 825-6(B) of the *2018 Standard Specifications* for portions of foundations exposed above finished grade. Do not remove anchor bolt templates or pedestal or grade beam forms or erect metal poles or upright trusses onto foundations until concrete attains a compressive strength of at least 3,000 psi.

- (A) Drilled Piers

Before starting drilled pier construction, hold a predrill meeting to discuss the installation, monitoring and inspection of the drilled piers. Schedule this meeting after the Drilled Pier Contractor has mobilized to the site. The Resident or Division Traffic Engineer, Contractor and Drilled Pier Contractor Superintendent will attend this predrill meeting.

Do not excavate holes, install piles or allow equipment wheel loads or vibrations within 20 ft of completed piers until 16 hours after Drilled Pier concrete reaches initial set.

Check for correct drilled pier alignment and location before beginning drilling. Check plumbness of holes frequently during drilling.

Construct drilled piers with the minimum required diameters shown in the plans. Install piers with tip elevations no higher than shown in the plans or approved by the Engineer.

Excavate holes with equipment of the sizes required to construct drilled piers. Depending on the subsurface conditions encountered, drilling through rock and boulders may be required. Do not use blasting for drilled pier excavations.

Contain and dispose of drilling spoils and waste concrete as directed and in accordance with Section 802 of the *2018 Standard Specifications*. Drilling spoils consist of all materials and fluids removed from excavations.

If unstable, caving or sloughing materials are anticipated or encountered, stabilize holes with temporary casings and/or polymer slurry. Do not use telescoping temporary casings. If it becomes necessary to replace a temporary casing during drilling, backfill the excavation, insert a larger casing around the casing to be replaced or stabilize the excavation with polymer slurry before removing the temporary casing.



If temporary casings become stuck or the Contractor proposes leaving casings in place, temporary casings should be installed against undisturbed material. Unless otherwise approved, do not leave temporary casings in place for mast arm poles and cantilever signs. The Engineer will determine if casings may remain in place. If the Contractor proposes leaving temporary casings in place, do not begin drilling until a casing installation method is approved.

Use polymer slurry and additives to stabilize holes in accordance with the slurry manufacturer's recommendations. Provide mixing water and equipment suitable for polymer slurry. Maintain the required slurry properties at all times except for sand content.

Define a "sample set" as slurry samples collected from mid-height and within 2 ft of the bottom of holes. Take sample sets from excavations to test polymer slurry immediately after filling holes with slurry, at least every 4 hours thereafter and immediately before placing concrete. Do not place Drilled Pier concrete until both slurry samples from an excavation meet the required polymer slurry properties. If any slurry test results do not meet the requirements, the Engineer may suspend drilling until both samples from a sample set meet the required polymer slurry properties.

Remove soft and loose material from bottom of holes using augers to the satisfaction of the Engineer. Assemble rebar cages and place cages and Drilled Pier concrete in accordance with Subarticle 411-4(E) of the *2018 Standard Specifications* except for the following:

- (1) Inspections for tip resistance and bottom cleanliness are not required,
- (2) Temporary casings may remain in place if approved, and
- (3) Concrete placement may be paused near the top of pier elevations for anchor rod assembly installation and conduit placement or
- (4) If applicable, concrete placement may be stopped at bottom of grade beam or wings elevations for grade beam or wing construction.

If wet placement of concrete is anticipated or encountered, do not place Drilled Pier concrete until a concrete placement procedure is approved. If applicable, temporary casings and fluids may be removed when concrete placement is paused or stopped in accordance with the exceptions above provided holes are stable. Remove contaminated concrete from exposed Drilled Pier concrete after removing casings and fluids. If holes are unstable, do not remove temporary casings until a procedure for placing anchor rod assemblies and conduit or constructing grade beams or wings is approved.

Use collars to extend drilled piers above finished grade. Remove collars after Drilled Pier concrete sets and round top edges of piers.

If drilled piers are questionable, pile integrity testing (PIT) and further investigation may be required in accordance with Article 411-5 of the *2018 Standard Specifications*. A drilled pier will be considered defective in accordance with Subarticle 411-5(D) of the *2018 Standard Specifications* and drilled pier acceptance is based in part on the criteria in

Article 411-6 of the *2018 Standard Specifications* except for the top of pier tolerances in Subarticle 411-6(C) of the *2018 Standard Specifications*.

If a drilled pier is under further investigation, do not grout core holes, backfill around the pier or perform any work on the drilled pier until the Engineer accepts the pier. If the drilled pier is accepted, dewater and grout core holes and backfill around the pier with approved material to finished grade. If the Engineer determines a pier is unacceptable, remediation is required in accordance with Article 411-6 of the *2018 Standard Specifications*. No extension of completion date or time will be allowed for remediation of unacceptable drilled piers or post repair testing.

Permanently embed a plate in or mark top of piers with the pier diameter and depth, size and number of vertical reinforcing bars and the minimum compressive strength of the concrete mix at 28 days.

(B) Footings, Pedestals, Grade Beams and Wings

Excavate as necessary for footings, grade beams and wings in accordance with the plans, accepted submittals and Section 410 of the *2018 Standard Specifications*. If unstable, caving or sloughing materials are anticipated or encountered, shore foundation excavations as needed with an approved method. Notify the Engineer when foundation excavation is complete. Do not place concrete or reinforcing steel until excavation dimensions and foundation material are approved.

Construct cast-in-place reinforced concrete footings, pedestals, grade beams and wings with the dimensions shown in the plans and in accordance with Section 825 of the *2018 Standard Specifications*. Use forms to construct portions of pedestals and grade beams protruding above finished grade. Provide a chamfer with a 3/4" horizontal width for pedestal and grade beam edges exposed above finished grade. Place concrete against undisturbed soil or backfill and fill in accordance with Article 410-8 of the *2018 Standard Specifications*. Proper compaction around footings and wings is critical for foundations to resist uplift and torsion forces.

(C) Anchor Rod Assemblies

Size anchor rods for design and the required projection above top of foundations. Determine required anchor rod projections from nut, washer and base plate thicknesses, the protrusion of 3 to 5 anchor rod threads above top nuts after tightening and the distance of one nut thickness between top of foundations and bottom of leveling nuts.

Protect anchor rod threads from damage during storage and installation of anchor rod assemblies. Before placing anchor rods in foundations, turn nuts onto and off rods past leveling nut locations. Turn nuts with the effort of one workman using an ordinary wrench without a cheater bar. Report any thread damage to the Engineer that requires extra effort to turn nuts.

Arrange anchor rods symmetrically about center of base plate locations as shown in the plans. Set anchor rod elevations based on required projections above top of foundations.

Securely brace and hold rods in the correct position, orientation and alignment with a steel template. Do not weld to reinforcing steel, temporary casings or anchor rods.

Install top and leveling (bottom) nuts, washers and the base plate for each anchor rod assembly in accordance with the following procedure:

- (1) Turn leveling nuts onto anchor rods to a distance of one nut thickness between the top of foundation and bottom of leveling nuts. Place washers over anchor rods on top of leveling nuts.
- (2) Determine if nuts are level using a flat rigid template on top of washers. If necessary, lower leveling nuts to level the template in all directions or if applicable, lower nuts to tilt the template so the metal pole or upright truss will lean as shown in the plans. If leveling nuts and washers are not in full contact with the template, replace washers with galvanized beveled washers.
- (3) Verify the distance between the foundation and leveling nuts is no more than one nut thickness.
- (4) Place base plate with metal pole or upright truss over anchor rods on top of washers. High mount luminaires may be attached before erecting metal poles but do not attach cables, mast arms or trusses to metal poles or upright trusses at this time.
- (5) Place washers over anchor rods on top of base plate. Lubricate top nut bearing surfaces and exposed anchor rod threads above washers with beeswax, paraffin or other approved lubricant.
- (6) Turn top nuts onto anchor rods. If nuts are not in full contact with washers or washers are not in full contact with the base plate, replace washers with galvanized beveled washers.
- (7) Tighten top nuts to snug-tight with the full effort of one workman using a 12" wrench. Do not tighten any nut all at once. Turn top nuts in increments. Follow a star pattern cycling through each nut at least twice.
- (8) Repeat (7) for leveling nuts.
- (9) Replace washers above and below the base plate with galvanized beveled washers if the slope of any base plate face exceeds 1:20 (5%), any washer is not in firm contact with the base plate or any nut is not in firm contact with a washer. If any washers are replaced, repeat (7) and (8).
- (10) With top and leveling nuts snug-tight, mark each top nut on a corner at the intersection of 2 flats and a corresponding reference mark on the base plate. Mark top nuts and base plate with ink or paint that is not water-soluble. Use the turn-of-nut method for pretensioning. Do not pretension any nut all at once. Turn top nuts in increments for a total turn that meets the following nut rotation requirements:

<b>NUT ROTATION REQUIREMENTS (Turn-of-Nut Pretensioning Method)</b>	
<b>Anchor Rod Diameter, inch</b>	<b>Requirement</b>
$\leq 1 \frac{1}{2}$	1/3 turn (2 flats)
$> 1 \frac{1}{2}$	1/6 turn (1 flat)

Follow a star pattern cycling through each top nut at least twice.

- (11) Ensure nuts, washers and base plate are in firm contact with each other for each anchor rod. Cables, mast arms and trusses may now be attached to metal poles and upright trusses.

- (12) Between 4 and 14 days after pretensioning top nuts, use a torque wrench calibrated within the last 12 months to check nuts in the presence of the Engineer. Completely erect mast arm poles and cantilever signs and attach any hardware before checking top nuts for these structures. Check that top nuts meet the following torque requirements:

<b>TORQUE REQUIREMENTS</b>	
<b>Anchor Rod Diameter, inch</b>	<b>Requirement, ft-lb</b>
7/8	180
1	270
1 1/8	380
1 1/4	420
≥ 1 1/2	600

If necessary, retighten top nuts in the presence of the Engineer with a calibrated torque wrench to within  $\pm 10$  ft-lb of the required torque. Do not overtighten top nuts.

- (13) Do not grout under base plate.

### Measurement and Payment

Foundations and anchor rod assemblies for metal poles and upright trusses will be measured and paid for elsewhere in the contract.

No payment will be made for temporary casings that remain in drilled pier excavations. No payment will be made for PIT. No payment will be made for further investigation of defective piers. Further investigation of piers that are not defective will be paid as extra work in accordance with Article 104-7 of the *2018 Standard Specifications*. No payment will be made for remediation of unacceptable drilled piers or post repair testing.

### OVERHEAD AND DYNAMIC MESSAGE SIGN FOUNDATIONS:

(1-16-18)

SP9 R07

#### Description

Sign foundations include foundations for overhead and dynamic message signs (DMS) supported by metal poles or upright trusses. Sign foundations consist of footings with pedestals or drilled piers with or without grade beams or wings, conduit and anchor rod assemblies. Construct sign foundations in accordance with the contract and accepted submittals. Define “cantilever sign” as an overhead cantilever sign support in accordance with Figure 1-1 of the *AASHTO Standard Specifications for Structural Supports for Highway Signs, Luminaires and Traffic Signals*.

#### Materials

Use sign foundation materials that meet the *Foundations and Anchor Rod Assemblies for Metal Poles* provision.

#### Subsurface Conditions

Assume the following soil parameters and groundwater elevation for sign foundations unless these subsurface conditions are not applicable to sign locations:

- (A) Unit weight ( $\gamma$ ) = 120 pcf,
- (B) Friction angle ( $\phi$ ) = 30°,
- (C) Cohesion ( $c$ ) = 0 psf and
- (D) Groundwater 7 feet below finished grade.

A subsurface investigation is required if the Engineer determines these assumed subsurface conditions do not apply to a sign location and the sign cannot be moved. Subsurface conditions requiring a subsurface investigation include but are not limited to weathered or hard rock, boulders, very soft or loose soil, muck or shallow groundwater. No extension of completion date or time will be allowed for subsurface investigations.

### **Subsurface Investigations**

Use a prequalified geotechnical consultant to perform one standard penetration test (SPT) boring in accordance with ASTM D1586 at each sign location requiring a subsurface investigation. Rough grade sign locations to within 2 feet of finished grade before beginning drilling. Drill borings to 2 drilled pier diameters below anticipated pier tip elevations or refusal, whichever is higher.

Use the computer software gINT version V8i or later manufactured by Bentley Systems, Inc. with the current NCDOT gINT library and data template to produce SPT boring logs. Provide boring logs sealed by a geologist or engineer licensed in the state of North Carolina.

### **Sign Foundation Designs**

Design sign foundations for the wind zone and clearances shown in the plans and the slope of finished grade at each sign location. Use the assumed soil parameters and groundwater elevation above for sign foundation designs unless a subsurface investigation is required. For sign locations requiring a subsurface investigation, design sign foundations for the subsurface conditions at each sign location. Design footings, pedestals, drilled piers, grade beams and wings in accordance with the *AASHTO Standard Specifications for Structural Supports for Highway Signs, Luminaires and Traffic Signals*. In some instances, conflicts with drainage structures may dictate sign foundation types.

Design footings in accordance with Section 4.4 of the *AASHTO Standard Specifications for Highway Bridges*. Do not use an allowable bearing pressure of more than 3,000 psf for footings. Design drilled piers for side resistance only in accordance with Section 4.6 of the *AASHTO Standard Specifications for Highway Bridges* except reduce ultimate side resistance by 25% for uplift. Use the computer software LPILE version 2016 or later manufactured by Ensoft, Inc. to analyze drilled piers. Provide drilled pier designs with a horizontal deflection of less than 1" at top of piers. For cantilever signs with single drilled pier foundations supporting metal poles, use wings to resist torsion forces. Provide drilled pier designs with a factor of safety of at least 2.0 for torsion.

For drilled pier sign foundations supporting upright trusses, use dual drilled piers connected with a grade beam having a moment of inertia approximately equal to that of either pier. The Broms' method is acceptable to analyze drilled piers with grade beams instead of LPILE. Use a safety factor of at least 3.5 for the Broms' design method in accordance with C13.6.1.1 of the *AASHTO*



								Min.	Max.	Min.	Max.
<i>Units</i>	<i>psi</i>					<i>inch</i>	<i>inch</i>	<i>lb/cy</i>	<i>lb/cy</i>	<i>lb/cy</i>	<i>lb/cy</i>
AA	4500	0.381	0.426	---	---	3.5 <sup>A</sup>	---	639	715	---	---
AA Slip Form	4500	0.381	0.426	---	---	1.5	---	639	715	---	---
Drilled Pier	4500	---	---	0.450	0.450	---	5 - 7 dry 7 - 9 wet	---	---	640	800
A	3000	0.488	0.532	0.550	0.594	3.5 <sup>A</sup>	4.0	564	---	602	---
B	2500	0.488	0.567	0.559	0.630	1.5 machine placed 2.5 <sup>A</sup> hand placed	4.0	508	---	545	---
Sand Light-weight	4500	---	0.420	---	---	4.0 <sup>A</sup>	---	715	---	---	---
Latex Modified	3000 (at 7 days)	0.400	0.400	---	---	6.0	---	658	---	---	---
Flowable Fill excavatable	150 max. (at 56 days)	as needed	as needed	as needed	as needed	---	Flowable	---	---	40	100
Flowable Fill non-excavatable	125	as needed	as needed	as needed	as needed	---	Flowable	---	---	100	as needed
Pavement	4500 Design, field 650 flexural, design only	0.559	0.559	---	---	1.5 slip form 3.0 hand placed	---	526	---	---	---
Precast	See Table 1077-1	as needed	as needed	---	---	6.0	as needed	as needed	as needed	as needed	as needed
Prestressed	per contract	See Table 1078-1	See Table 1078-1	---	---	8.0	---	564	as needed	---	---

- A. The slump may be increased to 6 inches, provided the increase in slump is achieved by adding a chemical admixture conforming to Section 1024-3. In no case shall the water-cement ratio on the approved design be exceeded. Concrete exhibiting segregation and/or excessive bleeding will be rejected. Utilizing an Admixture to modify slump does not relinquish the contractor's responsibility to ensure the final product quality and overall configuration meets design specifications. Caution should be taken when placing these modified mixes on steep grades to prevent unintended changes to the set slope.

**HIGH STRENGTH CONCRETE FOR DRIVEWAYS:**

(11-21-00) (Rev. 1-17-12)

848

SP10 R02

Use high early strength concrete for all driveways shown in the plans and as directed by the Engineer. Provide high early strength concrete that meets the requirements of Article 1000-5 of the *2018 Standard Specifications*.

Measurement and payment will be in accordance with Section 848 of the *2018 Standard Specifications*.

**THERMOPLASTIC PAVEMENT MARKING MATERIAL – COLOR TESTING:**

3-19-19

1087

SP10 R05

Revise the *2018 Standard Specifications* as follows:

**Pages 10-183 and 10-184, Subarticle 1087-7(D)(1)(b) Yellow**, lines 9-11, delete and replace with the following:

Obtain Color Values Y,x,y per ASTM E1349 using C/2° illuminant/observer.  
Results shall be  $Y \geq 45\%$ , and x,y shall fall within PR#1 chart chromaticity limits.

**SNOWPLOWABLE PAVEMENT MARKERS:**

3-19-19

1086, 1250, 1253

SP10 R07

Revise the *2018 Standard Specifications* as follows:

**Pages 10-177 and 10-178, Subarticle 1086-3 SNOWPLOWABLE PAVEMENT MARKERS**, delete items (A), (B) and (C)(1) and replace with the following:

**(A) General**

Use snowplowable pavement markers evaluated by NTPEP. The snowplowable pavement marker shall consist of a housing with one or more glass or plastic face lens type reflective lenses to provide the required color designation. Shape the housing to deflect a snowplow blade upward in both directions without being damaged. Plastic lens faces shall use an abrasion resistant coating.

Use recycled snowplowable pavement markers that meet all the requirements of new snowplowable pavement markers except Subarticle 1086-3(B)(1). Recycled snowplowable pavement markers with minimal variation in dimensions are acceptable only when the reflector fits in the housing of the recycled snowplowable pavement marker as originally designed.

**(B) Housings****(1) Dimensions**

The dimension, slope and minimum area of reflecting surface shall conform to dimensions as shown in the plans. The minimum area of each reflecting surface shall be 1.44 sq.in.

**(2) Materials**



Use snowplowable pavement markers that are on the NCDOT Approved Products List.

(3) Surface

The surface of the housing shall be free of scale, dirt, rust, oil, grease or any other contaminant which might reduce its bond to the epoxy adhesive.

(4) Identification

Mark the housing with the manufacturer's name and model number of marker.

**(C) Reflectors**

(1) General

Laminate the reflector to an elastomeric pad and attach with adhesive to the housing. The thickness of the elastomeric pad shall be 0.04".

**Pages 12-14, Subarticle 1250-3(C) Removal of Existing Pavement Markers, lines 19-29, delete and replace with the following:**

Remove the existing raised pavement markers or the snowplowable pavement markers including the housings, before overlaying an existing roadway with pavement. Repair the pavement by filling holes as directed by the Engineer.

When traffic patterns are changed in work zones due to construction or reconstruction, remove all raised pavement markers or snowplowable markers including housings that conflict with the new traffic pattern before switching traffic to the new traffic pattern. Lens removal in lieu of total housing removal is not an acceptable practice for snowplowable markers.

Properly dispose of the removed pavement markers. No direct payment will be made for removal or disposal of existing pavement markers or repair of pavement, as such work will be incidental to other items in the contract.

**Pages 12-16 and 12-17, Subarticle 1253-3 CONSTRUCTION METHODS, delete items (A), (B) and (C) and replace with the following:**

**(A) General**

Bond marker housings to the pavement with epoxy adhesive. Mechanically mix and dispense epoxy adhesives as required by the manufacturer's specifications. Place the markers immediately after the adhesive has been mixed and dispensed.

Install snowplowable pavement marker housings into slots sawcut into the pavement. Make slots in the pavement to exactly duplicate the shape of the housing of the snowplowable pavement markers.

Promptly remove all debris resulting from the saw cutting operation from the pavement surface. Install the marker housings within 7 calendar days after saw cutting slots in the pavement. Remove and dispose of loose material from the slots by brushing, blow cleaning or vacuuming. Dry the slots before applying the epoxy adhesive. Fill the cleaned slots totally with epoxy adhesive flush with the surface of the existing pavement. Install snowplowable pavement markers according to the manufacturer's recommendations.

Protect the snowplowable pavement markers until the epoxy has initially cured and is track free.

### **(B) Reflector Replacement**

In the event that a reflector is damaged, replace the damaged reflector by using adhesives and methods recommended by the manufacturer of the markers and approved by the Engineer. This work is considered incidental if damage occurs during the initial installation of the marker housings and maintenance of initial snowplowable markers specified in this section. This work will be paid for under the pay item for the type of reflector replacement if the damage occurred after the initial installation of the snowplowable pavement marker.

Missing housings shall be replaced. Broken housings shall be removed and replaced. In both cases the slot for the housings shall be properly prepared prior to installing the new housing. Removal of broken housings and preparation of slots will be considered incidental to the work of replacing housings.

### **(C) Recycled Snowplowable Pavement Marker Housings**

Use properly refurbished snowplowable pavement marker housings as approved by the Engineer such that approved new reflectors can be installed inside the housings.

### **MATERIALS FOR PORTLAND CEMENT CONCRETE:**

(9-15-20)

1000, 1024

SP10 R24

Revise the *2018 Standard Specifications* as follows:

**Page 10-52, Article 1024-4, WATER, lines 3-6,** delete and replace with the following:  
Test water from wells at all locations. Test public water supplies from all out of state locations and in the following counties: Beaufort, Bertie, Brunswick, Camden, Carteret, Chowan, Craven, Currituck, Dare, Gates, Hyde, New Hanover, Onslow, Pamlico, Pasquotank, Pender, Perquimans, Tyrell and Washington unless the Engineer waives the testing requirements.

**Page 10-52, Table 1024-2, PHYSICAL PROPERTIES OF WATER,** replace with the following:

<b>Property</b>	<b>Requirement</b>	<b>Test Method</b>
Compression Strength, minimum percent of control at 3 and 7 days	90%	ASTM C1602
Time of set, deviation from control	From 1:00 hr. earlier to 1:30 hr. later	ASTM C1602
pH	4.5 to 8.5	ASTM D1293 *
Chloride Ion Content, Max.	250 ppm	ASTM D512 *
Total Solids Content (Residue), Max.	1,000 ppm	SM 2540B *

Resistivity, Min.	0.500 kohm-cm	ASTM D1125 *
-------------------	---------------	--------------

\*Denotes an alternate method is acceptable. Test method used shall be referenced in the test report.

### **TEMPORARY SHORING:**

(2-20-07) (Rev. 1-16-18)

SP11 R02

#### **Description**

Temporary shoring includes cantilever, braced and anchored shoring and temporary mechanically stabilized earth (MSE) walls. Temporary shoring does not include trench boxes. At the Contractor's option, use any type of temporary shoring unless noted otherwise in the plans or as directed. Design and construct temporary shoring based on actual elevations and shoring dimensions in accordance with the contract and accepted submittals. Construct temporary shoring at locations shown in the plans and as directed. Temporary shoring is required to maintain traffic when a 2:1 (H:V) slope from the top of an embankment or bottom of an excavation will intersect the existing ground line less than 5 feet from the edge of pavement of an open travelway. This provision does not apply to pipe, inlet or utility installation unless noted otherwise in the plans.

Positive protection includes concrete barrier and temporary guardrail. Provide positive protection for temporary shoring at locations shown in the plans and as directed. Positive protection is required if temporary shoring is located in the clear zone in accordance with the *AASHTO Roadside Design Guide*.

#### (A) Cantilever and Braced Shoring

Cantilever shoring consists of steel sheet piles or H-piles with timber lagging. Braced shoring consists of sheet piles or H-piles with timber lagging and bracing such as beams, plates, walers, struts, rakers, etc. Define "piles" as sheet piles or H-piles.

#### (B) Anchored Shoring

Anchored shoring consists of sheet piles with walers or H-piles with timber lagging anchored with ground or helical anchors. Driven anchors may be accepted at the discretion of the Engineer. A ground anchor consists of a grouted steel bar or multi-strand tendon with an anchorage. A helical anchor consists of a lead section with a central steel shaft and at least one helix steel plate followed by extensions with only central shafts (no helixes) and an anchorage. Anchorages consist of steel bearing plates with washers and hex nuts for bars or steel wedge plates and wedges for strands. Use a prequalified Anchored Wall Contractor to install ground anchors. Define "anchors" as ground, helical or driven anchors.

#### (C) Temporary MSE Walls

Temporary MSE walls include temporary geosynthetic and wire walls. Define "temporary wall" as a temporary MSE wall and "Temporary Wall Vendor" as the vendor supplying the temporary MSE wall. Define "reinforcement" as geotextile, geogrid, welded wire grid or metallic strip reinforcement.

Temporary geosynthetic walls consist of geotextile or geogrid reinforcement wrapped behind welded wire facing. Define “temporary geotextile wall” as a temporary geosynthetic wall with geotextile reinforcement and “temporary geogrid wall” as a temporary geosynthetic wall with geogrid reinforcement.

Temporary wire walls consist of welded wire grid or metallic strip reinforcement connected to welded wire facing. Define “Wire Wall Vendor” as the vendor supplying the temporary wire wall.

(D) Embedment

Define “embedment” for cantilever, braced and anchored shoring as the pile depth below the grade in front of shoring. Define “embedment” for temporary walls as the wall height below the grade in front of walls.

(E) Positive Protection

Define “unanchored or anchored portable concrete barrier” as portable concrete barrier (PCB) that meets 2018 Roadway Standard Drawing No. 1170.01. Define “concrete barrier” as unanchored or anchored PCB or an approved equal. Define “temporary guardrail” as temporary steel beam guardrail that meets 2018 Roadway Standard Drawing No. 862.02.

## Materials

Refer to the *2018 Standard Specifications*.

<b>Item</b>	<b>Section</b>
Concrete Barrier Materials	1170-2
Flowable Fill, Excavatable	1000-6
Geosynthetics	1056
Neat Cement Grout	1003
Portland Cement Concrete	1000
Select Materials	1016
Steel Beam Guardrail Materials	862-2
Steel Plates	1072-2
Steel Sheet Piles and H-Piles	1084
Untreated Timber	1082-2
Welded Wire Reinforcement	1070-3

Provide Type 6 material certifications for shoring materials in accordance with Article 106-3 of the *2018 Standard Specifications*. Use Class IV select material for temporary guardrail. Use neat cement grout for Type 2 grout for ground anchors. Use Class A concrete that meets Article 450-2 of the *2018 Standard Specifications* or Type 1 grout for drilled-in piles. Provide untreated timber with a thickness of at least 3 inches and a bending stress of at least 1,000 pounds per square inch for timber lagging. Provide steel bracing that meets ASTM A36.

**(A) Shoring Backfill**

Use Class II, Type 1, Class III, Class V or Class VI select material or material that meets AASHTO M 145 for soil classification A-2-4 with a maximum PI of 6 for shoring backfill except do not use A-2-4 soil for backfill around culverts.

**(B) Anchors**

Store anchor materials on blocking a minimum of 12 inches above the ground and protect it at all times from damage; and when placing in the work make sure it is free from dirt, dust, loose mill scale, loose rust, paint, oil or other foreign materials. Load, transport, unload and store anchor materials so materials are kept clean and free of damage. Bent, damaged or defective materials will be rejected.

**(1) Ground Anchors**

Use high-strength deformed steel bars that meet AASHTO M 275 or seven-wire strands that meet ASTM A886 or Article 1070-5 of the *2018 Standard Specifications*. Splice bars in accordance with Article 1070-9 of the *2018 Standard Specifications*. Do not splice strands. Use bondbreakers, spacers and centralizers that meet Article 6.3.5 of the *AASHTO LRFD Bridge Construction Specifications*.

**(2) Helical Anchors**

Use helical anchors with an ICC Evaluation Service, Inc. (ICC-ES) report. Provide couplers, thread bar adapters and bolts recommended by the Anchor Manufacturer to connect helical anchors together and to piles.

**(3) Anchorages**

Provide steel plates for bearing plates and steel washers, hex nuts, wedge plates and wedges recommended by the Anchor Manufacturer.

**(C) Temporary Walls****(1) Welded Wire Facing**

Use welded wire reinforcement for welded wire facing, struts and wires. For temporary wire walls, provide welded wire facing supplied by the Wire Wall Vendor or a manufacturer approved or licensed by the vendor. For temporary wire walls with separate reinforcement and facing components, provide connectors (e.g., bars, clamps, plates, etc.) and fasteners (e.g., bolts, nuts, washers, etc.) required by the Wire Wall Vendor.

## (2) Geotextiles

Provide Type 2 geotextile for separation and retention geotextiles. Provide Type 5 geotextile for geotextile reinforcement with ultimate tensile strengths in accordance with the accepted submittals.

## (3) Geogrid Reinforcement

Use geogrids with a roll width of at least 4 feet and an “approved” or “approved for provisional use” status code. The list of approved geogrids is available from: [connect.ncdot.gov/resources/Materials/Pages/Materials-Manual-by-Material.aspx](http://connect.ncdot.gov/resources/Materials/Pages/Materials-Manual-by-Material.aspx)

Provide geogrids for geogrid reinforcement with design strengths in accordance with the accepted submittals. Geogrids are typically approved for ultimate tensile strengths in the machine direction (MD) and cross-machine direction (CD) or short-term design strengths for a 3-year design life in the MD based on material type. Define material type from the website above for shoring backfill as follows:

Material Type	Shoring Backfill
Borrow	A-2-4 Soil
Fine Aggregate	Class II, Type 1 or Class III Select Material
Coarse Aggregate	Class V or VI Select Material

## (4) Welded Wire Grid and Metallic Strip Reinforcement

Provide welded wire grid and metallic strip reinforcement supplied by the Wire Wall Vendor or a manufacturer approved or licensed by the vendor. Use welded wire grid reinforcement (“mesh”, “mats” and “ladders”) that meet Article 1070-3 of the *2018 Standard Specifications* and metallic strip reinforcement (“straps”) that meet ASTM A572 or A1011.

**Preconstruction Requirements**

## (A) Concrete Barrier

Define “clear distance” behind concrete barrier as the horizontal distance between the barrier and edge of pavement. The minimum required clear distance for concrete barrier is shown in the plans. At the Contractor’s option or if the minimum required clear distance is not available, set concrete barrier next to and up against traffic side of temporary shoring except for barrier above temporary walls. Concrete barrier with the minimum required clear distance is required above temporary walls.

## (B) Temporary Guardrail

Define “clear distance” behind temporary guardrail as the horizontal distance between guardrail posts and temporary shoring. At the Contractor’s option or if clear distance for cantilever, braced and anchored shoring is less than 4 feet, attach guardrail to traffic side

of shoring as shown in the plans. Place ABC in clear distance and around guardrail posts instead of pavement. Do not use temporary guardrail above temporary walls.

(C) Temporary Shoring Designs

Before beginning temporary shoring design, survey existing ground elevations in the vicinity of shoring locations to determine actual design heights (H). Submit PDF files of working drawings and design calculations for temporary shoring designs in accordance with Article 105-2 of the *2018 Standard Specifications*. Submit working drawings showing plan views, shoring profiles, typical sections and details of temporary shoring design and construction sequence. Do not begin shoring construction until a design submittal is accepted.

Have cantilever and braced shoring designed, detailed and sealed by an engineer licensed in the state of North Carolina. Use a prequalified Anchored Wall Design Consultant to design anchored shoring. Provide anchored shoring designs sealed by a Design Engineer approved as a Geotechnical Engineer (key person) for an Anchored Wall Design Consultant. Include details in anchored shoring working drawings of anchor locations and lock-off loads, unit grout/ground bond strengths for ground anchors or minimum installation torque and torsional strength rating for helical anchors and if necessary, obstructions extending through shoring or interfering with anchors. Include details in the anchored shoring construction sequence of pile and anchor installation, excavation and anchor testing.

Provide temporary wall designs sealed by a Design Engineer licensed in the state of North Carolina and employed or contracted by the Temporary Wall Vendor. Include details in temporary wall working drawings of geotextile and reinforcement types, locations and directions and obstructions extending through walls or interfering with reinforcement.

(1) Soil Parameters

Design temporary shoring for the assumed soil parameters and groundwater elevations shown in the plans. Assume the following soil parameters for shoring backfill:

(a) Unit weight ( $\gamma$ ) = 120 pcf;

Friction Angle ( $\phi$ )	Shoring Backfill
30°	A-2-4 Soil
34°	Class II, Type 1 or Class III Select Material
38°	Class V or VI Select Material

(c) Cohesion (c) = 0 psf.

## (2) Traffic Surcharge

Design temporary shoring for a traffic surcharge of 250 pounds per square foot if traffic will be above and within H of shoring. This traffic surcharge does not apply to construction traffic. Design temporary shoring for any construction surcharge if construction traffic will be above and within H of shoring. For LRFD shoring designs, apply traffic (live load) surcharge in accordance with Figure C11.5.5-3 of the *AASHTO LRFD Bridge Design Specifications*.

## (3) Cantilever, Braced and Anchored Shoring Designs

Use shoring backfill for fill sections and voids between cantilever, braced and anchored shoring and the critical failure surface. Use concrete or grout for embedded portions of drilled-in H-piles. Do not use drilled-in sheet piles.

Define “top of shoring” for cantilever, braced and anchored shoring as where the grade intersects the back of sheet piles or H-piles and timber lagging. Design cantilever, braced and anchored shoring for a traffic impact load of 2,000 pounds per foot applied 18 inches above top of shoring if concrete barrier is above and next to shoring or temporary guardrail is above and attached to shoring. For anchored shoring designs, apply traffic impact load as horizontal load ( $P_{HI}$ ) in accordance with Figure 3.11.6.3-2(a) of the *AASHTO LRFD specifications*.

Extend cantilever, braced and anchored shoring at least 32 inches above top of shoring if shoring is designed for traffic impact. Otherwise, extend shoring at least 6 inches above top of shoring.

Design cantilever, braced and anchored shoring for a maximum deflection of 3 inches if the horizontal distance to the closest edge of pavement or structure is less than H. Otherwise, design shoring for a maximum deflection of 6 inches. Design cantilever and braced shoring in accordance with the plans and *AASHTO Guide Design Specifications for Bridge Temporary Works*.

Design anchored shoring in accordance with the plans and Article 11.9 of the *AASHTO LRFD Bridge Design Specifications*. Use a resistance factor of 0.80 for tensile resistance of anchors with bars, strands or shafts. Extend the unbonded length for ground anchors and the shallowest helix for helical anchors at least 5 feet behind the critical failure surface. Do not extend anchors beyond right-of-way or easement limits. If existing or future obstructions such as foundations, guardrail posts, pavements, pipes, inlets or utilities will interfere with anchors, maintain a clearance of at least 6 inches between obstructions and anchors.

## (4) Temporary Wall Designs

Use shoring backfill in the reinforced zone of temporary walls. Separation geotextiles are required between shoring backfill and backfill, natural ground or culverts along the sides of the reinforced zone perpendicular to the wall face. For Class V or VI select material in the reinforced zone, separation geotextiles are also



required between shoring backfill and backfill or natural ground on top of and at the back of the reinforced zone.

Design temporary walls in accordance with the plans and Article 11.10 of the *AASHTO LRFD Bridge Design Specifications*. Embed temporary walls at least 18 inches except for walls on structures or rock as determined by the Engineer. Use a uniform reinforcement length throughout the wall height of at least  $0.7H$  or 6 feet, whichever is longer. Extend the reinforced zone at least 6 inches beyond end of reinforcement. Do not locate the reinforced zone outside right-of-way or easement limits.

Use the simplified method for determining maximum reinforcement loads in accordance with the AASHTO LRFD specifications. For geotextile reinforcement, use geotextile properties approved by the Department or default values in accordance with the AASHTO LRFD specifications. For geogrid reinforcement, use approved geogrid properties available from the website shown elsewhere in this provision. If the website does not list a short-term design strength for an approved geogrid, use a short-term design strength equal to the ultimate tensile strength divided by 3.5 for the geogrid reinforcement. Use geosynthetic properties for the direction reinforcement will be installed, a 3-year design life and shoring backfill to be used in the reinforced zone.

Do not use more than 4 different reinforcement strengths for each temporary geosynthetic wall. Design temporary geotextile walls for a reinforcement coverage ratio ( $R_c$ ) of 1.0. For temporary geogrid walls with an  $R_c$  of less than 1.0, use a maximum horizontal clearance between geogrids of 3 feet and stagger reinforcement so geogrids are centered over gaps in the reinforcement layer below.

For temporary geosynthetic walls, use “L” shaped welded wire facing with 18 to 24 inch long legs. Locate geotextile or geogrid reinforcement so reinforcement layers are at the same level as the horizontal legs of welded wire facing. Use vertical reinforcement spacing equal to facing height. Wrap geotextile or geogrid reinforcement behind welded wire facing and extend reinforcement at least 3 feet back behind facing into shoring backfill.

For temporary wire walls with separate reinforcement and facing components, attach welded wire grid or metallic strip reinforcement to welded wire facing with a connection approved by the Department. For temporary geogrid and wire walls, retain shoring backfill at welded wire facing with retention geotextiles and extend geotextiles at least 3 feet back behind facing into backfill.

(D) Preconstruction Meeting

The Engineer may require a shoring preconstruction meeting to discuss the construction, inspection and testing of the temporary shoring. If required and if this meeting occurs before all shoring submittals have been accepted, additional preconstruction meetings may be required before beginning construction of temporary shoring without accepted submittals. The Resident, District or Bridge Maintenance Engineer, Area Construction

Engineer, Geotechnical Operations Engineer, Contractor and Shoring Contractor Superintendent will attend preconstruction meetings.

### **Construction Methods**

Control drainage during construction in the vicinity of shoring. Direct run off away from shoring and shoring backfill. Contain and maintain backfill and protect material from erosion.

Install positive protection in accordance with the contract and accepted submittals. Use PCB in accordance with Section 1170 of the *2018 Standard Specifications* and 2018 Roadway Standard Drawing No. 1170.01. Use temporary guardrail in accordance with Section 862 of the *2018 Standard Specifications* and 2018 Roadway Standard Drawing Nos. 862.01, 862.02 and 862.03.

#### **(A) Tolerances**

Construct shoring with the following tolerances:

- (1) Horizontal wires of welded wire facing are level in all directions,
- (2) Shoring location is within 6 inches of horizontal and vertical alignment shown in the accepted submittals, and
- (3) Shoring plumbness (batter) is not negative and within 2 degrees of vertical.

#### **(B) Cantilever, Braced and Anchored Shoring Installation**

If overexcavation behind cantilever, braced or anchored shoring is shown in the accepted submittals, excavate before installing piles. Otherwise, install piles before excavating for shoring. Install cantilever, braced or anchored shoring in accordance with the construction sequence shown in the accepted submittals. Remove piles and if applicable, timber lagging when shoring is no longer needed.

##### **(1) Pile Installation**

Install piles with the minimum required embedment and extension in accordance with Subarticles 450-3(D) and 450-3(E) of the *2018 Standard Specifications* except that a pile driving equipment data form is not required. Piles may be installed with a vibratory hammer as approved by the Engineer.

Do not splice sheet piles. Use pile excavation to install drilled-in H-piles. After filling holes with concrete or grout to the elevations shown in the accepted submittals, remove any fluids and fill remaining portions of holes with flowable fill. Cure concrete or grout at least 7 days before excavating.

Notify the Engineer if refusal is reached before pile excavation or driven piles attain the minimum required embedment. When this occurs, a revised design submittal may be required.

## (2) Excavation

Excavate in front of piles from the top down in accordance with the accepted submittals. For H-piles with timber lagging and braced and anchored shoring, excavate in staged horizontal lifts with a maximum height of 5 feet. Remove flowable fill and material in between H-piles as needed to install timber lagging. Position lagging with at least 3 inches of contact in the horizontal direction between the lagging and pile flanges. Do not excavate the next lift until timber lagging for the current lift is installed and if applicable, bracing and anchors for the current lift are accepted. Backfill behind cantilever, braced or anchored shoring with shoring backfill.

## (3) Anchor Installation

If applicable, install foundations located behind anchored shoring before installing anchors. Fabricate and install ground anchors in accordance with the accepted submittals, Articles 6.4 and 6.5 of the *AASHTO LRFD Bridge Construction Specifications* and the following unless otherwise approved:

- (a) Materials in accordance with this provision are required instead of materials conforming to Articles 6.4 and 6.5.3 of the AASHTO LRFD Specifications,
- (b) Encapsulation-protected ground anchors in accordance with Article 6.4.1.2 of the AASHTO LRFD specifications are not required, and
- (c) Corrosion protection for unbonded lengths of ground anchors and anchorage covers are not required.
- (d) Measure grout temperature, density and flow during grouting with at least the same frequency grout cubes are made for compressive strength. Perform density and flow field tests in the presence of the Engineer in accordance with American National Standards Institute/American Petroleum Institute Recommended Practice 13B-1 (Section 4, Mud Balance) and ASTM C939 (Flow Cone), respectively.

Install helical anchors in accordance with the accepted submittals and Anchor Manufacturer's instructions. Measure torque during installation and do not exceed the torsional strength rating of the helical anchor. Attain the minimum required installation torque and penetration before terminating anchor installation. When replacing a helical anchor, embed last helix of the replacement anchor at least 3 helix plate diameters past the location of the first helix of the previous anchor.

## (4) Anchor Testing

Proof test and lock-off anchors in accordance with the accepted submittals and Article 6.5.5 of the *AASHTO LRFD Bridge Construction Specifications* except for the acceptance criteria in Article 6.5.5.5. For the AASHTO LRFD specifications,

“ground anchor” refers to a ground or helical anchor and “tendon” refers to a bar, strand or shaft.

(a) Anchor Acceptance

Anchor acceptance is based in part on the following criteria.

- (i) For ground and helical anchors, total movement is less than 0.04 inches between the 1 and 10 minute readings or less than 0.08 inches between the 6 and 60 minute readings.
- (ii) For ground anchors, total movement at maximum test load exceeds 80% of the theoretical elastic elongation of the unbonded length.

(b) Anchor Test Results

Submit PDF files of anchor test records including movement versus load plots for each load increment within 24 hours of completing each row of anchors. The Engineer will review the test records to determine if the anchors are acceptable.

If the Engineer determines an anchor is unacceptable, revise the anchor design or installation methods. Submit a revised anchored shoring design for acceptance and provide an acceptable anchor with the revised design or installation methods. If required, replace the anchor or provide additional anchors with the revised design or installation methods.

(C) Temporary Wall Installation

Excavate as necessary for temporary walls in accordance with the plans and accepted submittals. If applicable, install foundations located in the reinforced zone before placing shoring backfill or reinforcement unless otherwise approved. Notify the Engineer when foundation excavation is complete. Do not place shoring backfill or reinforcement until excavation dimensions and foundation material are approved.

Erect welded wire facing so the wall position is as shown in the plans and accepted submittals. Set welded wire facing adjacent to each other in the horizontal and vertical direction to completely cover the wall face with facing. Stagger welded wire facing to create a running bond by centering facing over joints in the row below.

Wrap geotextile reinforcement and retention geotextiles behind welded wire facing as shown in the plans and accepted submittals and cover geotextiles with at least 3" of shoring backfill. Overlap adjacent geotextile reinforcement and retention and separation geotextiles at least 18 inches with seams oriented perpendicular to the wall face. Hold geotextiles in place with wire staples or anchor pins as needed.

Place reinforcement within 3 inches of locations shown in the plans and accepted submittals. Before placing shoring backfill, pull reinforcement taut so it is in tension and free of kinks, folds, wrinkles or creases. Install reinforcement with the direction shown in

the plans and accepted submittals. For temporary wire walls with separate reinforcement and facing components, attach welded wire grid or metallic strip reinforcement to welded wire facing as shown in the accepted submittals. Do not splice or overlap reinforcement so seams are parallel to the wall face. Contact the Engineer when unanticipated existing or future obstructions such as foundations, pavements, pipes, inlets or utilities will interfere with reinforcement.

Place shoring backfill in the reinforced zone in 8 to 10 inch thick lifts. Compact A-2-4 soil and Class II, Type 1 and Class III select material in accordance with Subarticle 235-3(C) of the *2018 Standard Specifications*. Use only hand operated compaction equipment to compact backfill within 3 feet of welded wire facing. At a distance greater than 3 feet, compact shoring backfill with at least 4 passes of an 8 to 10 ton vibratory roller in a direction parallel to the wall face. Smooth wheeled or rubber tired rollers are also acceptable for compacting backfill. Do not use sheepsfoot, grid rollers or other types of compaction equipment with feet. Do not displace or damage reinforcement when placing and compacting shoring backfill. End dumping directly on geotextile or geogrid reinforcement is not permitted. Do not operate heavy equipment on reinforcement until it is covered with at least 8 inches of shoring backfill. Replace any damaged reinforcement to the satisfaction of the Engineer.

Backfill for temporary walls outside the reinforced zone in accordance with Article 410-8 of the *2018 Standard Specifications*. Bench temporary walls into the sides of excavations where applicable. For temporary geosynthetic walls with top of wall within 5 feet of finished grade, remove top facing and incorporate top reinforcement layer into fill when placing fill in front of wall. Temporary walls remain in place permanently unless otherwise required.

### **Measurement and Payment**

*Temporary Shoring* will be measured and paid in square feet. Temporary walls will be measured as the square feet of exposed wall face area. Cantilever, braced or anchored shoring will be measured as the square feet of exposed shoring face area with the shoring height equal to the difference between the top and bottom of shoring elevations. Define “top of shoring” as where the grade intersects the back of sheet piles or H-piles and timber lagging. Define “bottom of shoring” as where the grade intersects front of sheet piles or H-piles and timber lagging. No measurement will be made for any embedment, shoring extension above top of shoring or pavement thickness above temporary walls.

The contract unit price for *Temporary Shoring* will be full compensation for providing shoring designs, submittals and materials, excavating, backfilling, hauling and removing excavated materials and supplying all labor, tools, equipment and incidentals necessary to construct temporary shoring.

No payment will be made for temporary shoring not shown in the plans or required by the Engineer including shoring for OSHA reasons or the Contractor’s convenience. No value engineering proposals will be accepted based solely on revising or eliminating shoring locations shown in the plans or estimated quantities shown in the bid item sheets as a result of actual field measurements or site conditions.

PCB will be measured and paid in accordance with Section 1170 of the *2018 Standard Specifications*. No additional payment will be made for anchoring PCB for temporary shoring. Costs for anchoring PCB will be incidental to temporary shoring.

Temporary guardrail will be measured and paid for in accordance with Section 862 of the *2018 Standard Specifications*.

Payment will be made under:

**Pay Item**  
Temporary Shoring

**Pay Unit**  
Square Foot

**EXTRUDED THERMOPLASTIC PAVEMENT MARKING THICKNESS:**

3-19-19

1205

SP12 R05

Revise the *2018 Standard Specifications* as follows:

**Page 12-6, Subarticle 1205-4(A)(1) General, lines 5-8,** delete the second sentence and replace with the following:

Use application equipment that provides multiple width settings ranging from 4 inches to 12 inches and multiple thickness settings to achieve a minimum pavement marking thickness of 0.090 inch above the surface of the pavement.

**Page 12-7, Table 1205-3, THICKNESS REQUIREMENTS FOR THERMOPLASTIC,** replace with the following:

<b>TABLE 1205-3 MINIMUM THICKNESS REQUIREMENTS FOR THERMOPLASTIC</b>	
<b>Thickness</b>	<b>Location</b>
240 mils	In-lane and shoulder-transverse pavement markings (rumble strips). May be placed in 2 passes.
90 mils	Center lines, skip lines, transverse bands, mini-skip lines, characters, bike lane symbols, crosswalk lines, edge lines, gore lines, diagonals, and arrow symbols

**ROADWAY LIGHTING FOUNDATIONS:**

(1-16-18)

SP14 R04

**Description**

Roadway lighting foundations include foundations for high mount and light standards. High mount foundations for high mount standards and standard foundations for light standards consist of drilled piers or footings with pedestals, conduit and anchor rod assemblies. Construct roadway lighting foundations in accordance with the contract, *2018 Roadway Standard Drawings* and accepted submittals. Define “high mount foundation” as a drilled pier including the conduit and anchor rod assembly that meets 2018 Roadway Standard Drawing No. 1402.01. Define “standard foundation” as a drilled pier or footing with pedestal including the conduit and anchor rod assembly that meets 2018 Roadway Standard Drawing No. 1405.01.

**Materials**

Use roadway lighting foundation materials that meet the *Foundations and Anchor Rod Assemblies for Metal Poles* provision. Provide metal shrouds for median mounted light standards in accordance with Subarticle 1400-4(I) of the *2018 Standard Specifications*.

**Roadway Lighting Foundations****(A) High Mount Foundations**

Construct high mount foundations for the wind zone and high mount heights shown in the plans unless the following assumed site conditions are not applicable to high mount locations:

- (E) Soil with unit weight ( $\gamma$ )  $\geq$  120 pcf and friction angle ( $\phi$ )  $\geq$  30°,
- (F) Groundwater at least 7 feet below finished grade and
- (G) Slope of finished grade 6:1 (H:V) or flatter.

A subsurface investigation and high mount foundation design are required if the Engineer determines these assumed site conditions do not apply to a high mount location and the high mount cannot be moved. Subsurface conditions requiring a high mount foundation design include but are not limited to weathered or hard rock, boulders, very soft or loose soil, muck or shallow groundwater. No extension of completion date or time will be allowed for subsurface investigations or high mount foundation designs.

**(B) Standard Foundations**

Construct standard foundation types for the light standard types shown in the plans and the site conditions at each light standard location. When weathered or hard rock, boulders or obstructions conflict with standard foundations, submit an alternate standard foundation design for acceptance in accordance with Article 105-2 of the *2018 Standard Specifications*. No extension of completion date or time will be allowed for alternate standard foundations.

**Subsurface Investigations**

Use a prequalified geotechnical consultant to perform one standard penetration test (SPT) boring in accordance with ASTM D1586 at each high mount location requiring a subsurface investigation. Rough grade high mount locations to within 2 ft of finished grade before beginning drilling. Drill borings to 2 drilled pier diameters below anticipated pier tip elevations or refusal, whichever is higher.

Use the computer software gINT version V8i or later manufactured by Bentley Systems, Inc. with the current NCDOT gINT library and data template to produce SPT boring logs. Provide boring logs sealed by a geologist or engineer licensed in the state of North Carolina.

**High Mount Foundation Designs**

Design high mount foundations for the wind zone and high mount heights shown in the plans and the slope of finished grade and subsurface conditions at each high mount location. Design drilled piers, footings and pedestals in accordance with the *AASHTO Standard Specifications for Structural Supports for Highway Signs, Luminaires and Traffic Signals*.

Design drilled piers for side resistance only in accordance with Section 4.6 of the *AASHTO Standard Specifications for Highway Bridges*. Use the computer software LPILE version 2016 or later manufactured by Ensoft, Inc. to analyze drilled piers. Provide drilled pier designs with a horizontal deflection of less than 0.5" at top of piers.

Design footings in accordance with Section 4.4 of the *AASHTO Standard Specifications for Highway Bridges*. Do not use an allowable bearing pressure of more than 3,000 psf for footings. Submit boring logs, working drawings and design calculations for acceptance in accordance with Article 105-2 of the *2018 Standard Specifications*. Submit working drawings showing plan views, required foundation dimensions and elevations and typical sections with reinforcement, conduit and anchor rod assembly details. Include all boring logs, design calculations and LPILE output for high mount foundation design submittals. Have high mount foundations designed, detailed and sealed by an engineer licensed in the state of North Carolina.

**Construction Methods**

Grade around roadway lighting locations with cut and fill slopes as shown on 2018 Roadway Standard Drawing No. 1402.01 or 1405.01. Construct drilled piers, footings and pedestals and install anchor rod assemblies for roadway lighting foundations in accordance with the *Foundations and Anchor Rod Assemblies for Metal Poles* provision.

For median mounted light standards, place concrete for median barriers and underlying pedestals in the same pour. Construct concrete barriers in accordance with the contract and make concrete median barriers continuous through standard foundations. Coordinate construction of median mounted light standards with sign structures, concrete barriers, drainage structures, etc. to avoid conflicts.

**Measurement and Payment**

*High Mount Foundations* will be measured and paid in cubic yards. High mount foundations will



be measured as the cubic yards of concrete shown on 2018 Roadway Standard Drawing No. 1402.01 for the high mount height and wind zone shown in the plans. All other high mount foundations will be measured as the cubic yards of foundation concrete for drilled piers, footings and pedestals shown in the accepted submittals. Subsurface investigations and high mount foundation designs required by the Engineer will be paid as extra work in accordance with Article 104-7 of the *2018 Standard Specifications*.

*Standard Foundation* \_\_\_\_ will be measured and paid in units of each. Standard foundations will be measured as the number of each standard foundation type. Alternate standard foundations will be measured as 1.5 times the number of each standard foundation type replaced.

The contract unit prices for *High Mount Foundations* and *Standard Foundation* \_\_\_\_ will be full compensation for providing labor, tools, equipment and foundation materials, stabilizing or shoring excavations, supplying and placing concrete, reinforcing steel, conduit, anchor rod assemblies and any incidentals necessary to construct roadway lighting foundations.

Payment will be made under:

**Pay Item**

High Mount Foundations  
Standard Foundation \_\_\_\_

**Pay Unit**

Cubic Yard  
Each

**STANDARD SPECIAL PROVISION**  
**AVAILABILITY OF FUNDS – TERMINATION OF CONTRACTS**

(5-20-08)

Z-2

*General Statute 143C-6-11. (h) Highway Appropriation* is hereby incorporated verbatim in this contract as follows:

(h) Amounts Encumbered. – Transportation project appropriations may be encumbered in the amount of allotments made to the Department of Transportation by the Director for the estimated payments for transportation project contract work to be performed in the appropriation fiscal year. The allotments shall be multiyear allotments and shall be based on estimated revenues and shall be subject to the maximum contract authority contained in *General Statute 143C-6-11(c)*. Payment for transportation project work performed pursuant to contract in any fiscal year other than the current fiscal year is subject to appropriations by the General Assembly. Transportation project contracts shall contain a schedule of estimated completion progress, and any acceleration of this progress shall be subject to the approval of the Department of Transportation provided funds are available. The State reserves the right to terminate or suspend any transportation project contract, and any transportation project contract shall be so terminated or suspended if funds will not be available for payment of the work to be performed during that fiscal year pursuant to the contract. In the event of termination of any contract, the contractor shall be given a written notice of termination at least 60 days before completion of scheduled work for which funds are available. In the event of termination, the contractor shall be paid for the work already performed in accordance with the contract specifications.

Payment will be made on any contract terminated pursuant to the special provision in accordance with Subarticle 108-13(D) of the *2018 Standard Specifications*.

**STANDARD SPECIAL PROVISION**  
**NCDOT GENERAL SEED SPECIFICATION FOR SEED QUALITY**

(5-17-11)

Z-3

Seed shall be sampled and tested by the North Carolina Department of Agriculture and Consumer Services, Seed Testing Laboratory. When said samples are collected, the vendor shall supply an independent laboratory report for each lot to be tested. Results from seed so sampled shall be final. Seed not meeting the specifications shall be rejected by the Department of Transportation and shall not be delivered to North Carolina Department of Transportation warehouses. If seed has been delivered it shall be available for pickup and replacement at the supplier's expense.

Any re-labeling required by the North Carolina Department of Agriculture and Consumer Services, Seed Testing Laboratory, that would cause the label to reflect as otherwise specified herein shall be rejected by the North Carolina Department of Transportation.

Seed shall be free from seeds of the noxious weeds Johnsongrass, Balloonvine, Jimsonweed, Witchweed, Itchgrass, Serrated Tussock, Showy Crotalaria, Smooth Crotalaria, Sicklepod, Sandbur, Wild Onion, and Wild Garlic. Seed shall not be labeled with the above weed species on the seed analysis label. Tolerances as applied by the Association of Official Seed Analysts will NOT be allowed for the above noxious weeds except for Wild Onion and Wild Garlic.

Tolerances established by the Association of Official Seed Analysts will generally be recognized. However, for the purpose of figuring pure live seed, the found pure seed and found germination percentages as reported by the North Carolina Department of Agriculture and Consumer Services, Seed Testing Laboratory will be used. Allowances, as established by the NCDOT, will be recognized for minimum pure live seed as listed on the following pages.

The specifications for restricted noxious weed seed refers to the number per pound as follows:

<b><u>Restricted Noxious Weed</u></b>	<b><u>Limitations per Lb. Of Seed</u></b>	<b><u>Restricted Noxious Weed</u></b>	<b><u>Limitations per Lb. of Seed</u></b>
Blessed Thistle	4 seeds	Cornflower (Ragged Robin)	27 seeds
Cocklebur	4 seeds	Texas Panicum	27 seeds
Spurred Anoda	4 seeds	Bracted Plantain	54 seeds
Velvetleaf	4 seeds	Buckhorn Plantain	54 seeds
Morning-glory	8 seeds	Broadleaf Dock	54 seeds
Corn Cockle	10 seeds	Curly Dock	54 seeds
Wild Radish	12 seeds	Dodder	54 seeds
Purple Nutsedge	27 seeds	Giant Foxtail	54 seeds
Yellow Nutsedge	27 seeds	Horsenettle	54 seeds
Canada Thistle	27 seeds	Quackgrass	54 seeds
Field Bindweed	27 seeds	Wild Mustard	54 seeds
Hedge Bindweed	27 seeds		

Seed of Pensacola Bahiagrass shall not contain more than 7% inert matter, Kentucky Bluegrass, Centipede and Fine or Hard Fescue shall not contain more than 5% inert matter whereas a maximum of 2% inert matter will be allowed on all other kinds of seed. In addition, all seed shall

not contain more than 2% other crop seed nor more than 1% total weed seed. The germination rate as tested by the North Carolina Department of Agriculture shall not fall below 70%, which includes both dormant and hard seed. Seed shall be labeled with not more than 7%, 5% or 2% inert matter (according to above specifications), 2% other crop seed and 1% total weed seed.

Exceptions may be made for minimum pure live seed allowances when cases of seed variety shortages are verified. Pure live seed percentages will be applied in a verified shortage situation. Those purchase orders of deficient seed lots will be credited with the percentage that the seed is deficient.

FURTHER SPECIFICATIONS FOR EACH SEED GROUP ARE GIVEN BELOW:

Minimum 85% pure live seed; maximum 1% total weed seed; maximum 2% total other crop seed; maximum 144 restricted noxious weed seed per pound. Seed less than 83% pure live seed will not be approved.

Sericea Lespedeza  
Oats (seeds)

Minimum 80% pure live seed; maximum 1% total weed seed; maximum 2% total other crop; maximum 144 restricted noxious weed seed per pound. Seed less than 78% pure live seed will not be approved.

Tall Fescue (all approved varieties)	Bermudagrass
Kobe Lespedeza	Browntop Millet
Korean Lespedeza	German Millet – Strain R
Weeping Lovegrass	Clover – Red/White/Crimson
Carpetgrass	

Minimum 78% pure live seed; maximum 1% total weed seed; maximum 2% total other crop seed; maximum 144 restricted noxious weed seed per pound. Seed less than 76% pure live seed will not be approved.

Common or Sweet Sundangrass

Minimum 76% pure live seed; maximum 1% total weed seed; maximum 2% total other crop seed; maximum 144 restricted noxious weed seed per pound. Seed less than 74% pure live seed will not be approved.

Rye (grain; all varieties)  
Kentucky Bluegrass (all approved varieties)  
Hard Fescue (all approved varieties)  
Shrub (bicolor) Lespedeza

Minimum 70% pure live seed; maximum 1% total weed seed; maximum 2% total other crop seed; maximum 144 noxious weed seed per pound. Seed less than 70% pure live seed will not be approved.

Centipedegrass	Japanese Millet
Crownvetch	Reed Canary Grass
Pensacola Bahiagrass	Zoysia
Creeping Red Fescue	

Minimum 70% pure live seed; maximum 1% total weed seed; maximum 2% total other crop seed; maximum 5% inert matter; maximum 144 restricted noxious weed seed per pound.

Barnyard Grass  
Big Bluestem  
Little Bluestem  
Bristly Locust  
Birdsfoot Trefoil  
Indiangrass  
Orchardgrass  
Switchgrass  
Yellow Blossom Sweet Clover

**STANDARD SPECIAL PROVISION****ERRATA**

(10-16-18) (Rev.2-16-21)

Z-4

Revise the *2018 Standard Specifications* as follows:

**Division 6**

**Page 6-7, Article 609-1 DESCRIPTION, line 29,** replace article number “609-10” with “609-9”.

**Division 7**

**Page 7-27, Article 725-1 MEASUREMENT AND PAYMENT, line 4,** replace article number “725-1” with “724-4”.

**Page 7-28, Article 725-1 MEASUREMENT AND PAYMENT, line 10,** replace article number “725-1” with “725-3”.

**Division 10**

**Page 10-78, Article 1056-4 GEOTEXTILES, TABLE 1056-1, Permittivity, Type 2,** replace “Table 6<sup>D</sup>” with “Table 7<sup>D</sup>” and **Permittivity, Type 3<sup>B</sup>,** replace “Table 7<sup>D</sup>” with “Table 8<sup>D</sup>”.

**Page 10-121, Article 1076-7, REPAIR OF GALVANIZING, line 8,** replace article number “1080-9” with “1080-7”.

**Page 10-162, Article 1080-50 PAINT FOR VERTICAL MARKERS, line 1,** replace article number “1080-50” with “1080-10”.

**Page 10-162, Article 1080-61 EPOXY RESIN FOR REINFORCING STEEL, line 5,** replace article number “1080-61” with “1080-11”.

**Page 10-162, Article 1080-72 ABRASIVE MATERIALS FOR BLAST CLEANING STEEL, line 22,** replace article number “1080-72” with “1080-12”.

**Page 10-163, Article 1080-83 FIELD PERFORMANCE AND SERVICES, line 25,** replace article number “1080-83” with “1080-13”.

**Division 17**

**Page 17-15, Article 1715-4 MEASUREMENT AND PAYMENT, lines 42-44,** replace the second sentence with the following:

An example is an installation of a single 1.25 inch HDPE conduit would be paid as:

Directional Drill (1)(1.25”) Linear Foot

**STANDARD SPECIAL PROVISION****PLANT AND PEST QUARANTINES****(Imported Fire Ant, Gypsy Moth, Witchweed, Emerald Ash Borer, Guava Root Knot Nematode, And Other Noxious Weeds)**

(3-18-03) (Rev. 5-21-19)

Z-04a

**Within Quarantined Area**

This project may be within a county regulated for plant and/or pests. If the project or any part of the Contractor's operations is located within a quarantined area, thoroughly clean all equipment prior to moving out of the quarantined area. Comply with federal/state regulations by obtaining a certificate or limited permit for any regulated article moving from the quarantined area.

**Originating in a Quarantined County**

Obtain a certificate or limited permit issued by the N.C. Department of Agriculture/United States Department of Agriculture. Have the certificate or limited permit accompany the article when it arrives at the project site.

**Contact**

Contact the N.C. Department of Agriculture/United States Department of Agriculture at 1-800-206-9333, 919-707-3730, or <https://www.ncagr.gov/plantindustry/Plant/quaran/table2.htm> to determine those specific project sites located in the quarantined area or for any regulated article used on this project originating in a quarantined county.

**Regulated Articles Include**

1. Soil, sand, gravel, compost, peat, humus, muck, and decomposed manure, separately or with other articles. This includes movement of articles listed above that may be associated with cut/waste, ditch pulling, and shoulder cutting.
2. Plants with roots including grass sod.
3. Plant crowns and roots.
4. Bulbs, corms, rhizomes, and tubers of ornamental plants.
5. Hay, straw, fodder, and plant litter of any kind.
6. Clearing and grubbing debris.
7. Used agricultural cultivating and harvesting equipment.
8. Used earth-moving equipment.
9. Any other products, articles, or means of conveyance, of any character, if determined by an inspector to present a hazard of spreading imported fire ant, gypsy moth, witchweed, emerald ash borer, guava root knot nematode, or other noxious weeds.

**STANDARD SPECIAL PROVISION****TITLE VI AND NONDISCRIMINATION:**

(6-28-77)(Rev 6/19/2018)

Z-6

Revise the *2018 Standard Specifications* as follows:

Replace Article 103-4(B) with the following:

The North Carolina Department of Transportation is committed to carrying out the U.S. Department of Transportation's policy of ensuring nondiscrimination in the award and administration of contracts.

The provisions of this section related to United States Department of Transportation (US DOT) Order 1050.2A, Title 49 Code of Federal Regulations (CFR) part 21, 23 United States Code (U.S.C.) 140 and 23 CFR part 200 (or 49 CFR 303, 49 U.S.C. 5332 or 49 U.S.C. 47123) are applicable to all North Carolina Department of Transportation (NCDOT) contracts and to all related subcontracts, material supply, engineering, architectural and other service contracts, regardless of dollar amount. Any Federal provision that is specifically required not specifically set forth is hereby incorporated by reference.

(1) **Title VI Assurances (USDOT Order 1050.2A, Appendix A)**

During the performance of this contract, the contractor, for itself, its assignees, and successors in interest (hereinafter referred to as the "contractor") agrees as follows:

(a) Compliance with Regulations

The contractor (hereinafter includes consultants) shall comply with the Acts and the Regulations relative to Nondiscrimination in Federally-assisted programs of the U.S. Department of Transportation, Federal Highway Administration (FHWA), as they may be amended from time to time, which are herein incorporated by reference and made a part of this contract.

(b) Nondiscrimination

The contractor, with regard to the work performed by it during the contract, shall not discriminate on the grounds of race, color, or national origin in the selection and retention of subcontractors, including procurements of materials and leases of equipment. The contractor shall not participate directly or indirectly in the discrimination prohibited by the Acts and the Regulations, including employment practices when the contract covers any activity, project, or program set forth in Appendix B of 49 CFR Part 21.

(c) Solicitations for Subcontractors, Including Procurements of Materials and Equipment

In all solicitations, either by competitive bidding, or negotiation made by the contractor for work to be performed under a subcontract, including procurements of materials, or leases of equipment, each potential subcontractor or supplier shall be notified by the contractor of the contractor's obligations under this contract and the Acts and the Regulations relative to Nondiscrimination on the grounds of race, color, or national origin.

(d) Information and Reports

The contractor shall provide all information and reports required by the Acts, the Regulations, and directives issued pursuant thereto and shall permit access to its books, records, accounts, other sources of information, and its facilities as may be determined by the Recipient or the FHWA to be pertinent to ascertain compliance with such Acts,



Regulations, and instructions. Where any information required of a contractor is in the exclusive possession of another who fails or refuses to furnish the information, the contractor shall so certify to the Recipient or the FHWA, as appropriate, and shall set forth what efforts it has made to obtain the information.

(e) Sanctions for Noncompliance:

In the event of a contractor's noncompliance with the Non-discrimination provisions of this contract, the Recipient will impose such contract sanctions as it and/or the FHWA may determine to be appropriate, including, but not limited to:

- (i) Withholding payments to the contractor under the contract until the contractor complies; and/or
- (ii) Cancelling, terminating, or suspending a contract, in whole or in part.

(f) Incorporation of Provisions

The contractor shall include the provisions of paragraphs (a) through (f) in every subcontract, including procurements of materials and leases of equipment, unless exempt by the Acts, the Regulations and directives issued pursuant thereto. The contractor shall take action with respect to any subcontract or procurement as the Recipient or the FHWA may direct as a means of enforcing such provisions including sanctions for noncompliance. Provided, that if the contractor becomes involved in, or is threatened with litigation by a subcontractor, or supplier because of such direction, the contractor may request the Recipient to enter into any litigation to protect the interests of the Recipient. In addition, the contractor may request the United States to enter into the litigation to protect the interests of the United States.

(2) **Title VI Nondiscrimination Program (23 CFR 200.5(p))**

The North Carolina Department of Transportation (NCDOT) has assured the USDOT that, as a condition to receiving federal financial assistance, NCDOT will comply with Title VI of the Civil Rights Act of 1964 and all requirements imposed by Title 49 CFR part 21 and related nondiscrimination authorities to ensure that no person shall, on the ground of race, color, national origin, limited English proficiency, sex, age, or disability (including religion/creed or income-level, where applicable), be excluded from participation in, be denied the benefits of, or be subjected to discrimination under any programs, activities, or services conducted or funded by NCDOT. Contractors and other organizations under contract or agreement with NCDOT must also comply with Title VI and related authorities, therefore:

(a) During the performance of this contract or agreement, contractors (e.g., subcontractors, consultants, vendors, prime contractors) are responsible for complying with NCDOT's Title VI Program. Contractors are not required to prepare or submit Title VI Programs. To comply with this section, the prime contractor shall:

1. Post NCDOT's Notice of Nondiscrimination and the Contractor's own Equal Employment Opportunity (EEO) Policy in conspicuous locations accessible to all employees, applicants and subcontractors on the jobsite.
2. Physically incorporate the required Title VI clauses into all subcontracts on federally-assisted and state-funded NCDOT projects, and ensure inclusion by subcontractors into all lower-tier subcontracts.
3. Required Solicitation Language. The Contractor shall include the following notification in all solicitations for bids and requests for work or material, regardless of funding source:

“The North Carolina Department of Transportation, in accordance with the provisions of Title VI of the Civil Rights Act of 1964 (78 Stat. 252, 42 U.S.C. §§

2000d to 2000d-4) and the Regulations, hereby notifies all bidders that it will affirmatively ensure that any contract entered into pursuant to this advertisement, disadvantaged business enterprises will be afforded full and fair opportunity to submit bids in response to this invitation and will not be discriminated against on the grounds of race, color, or national origin in consideration for an award. In accordance with other related nondiscrimination authorities, bidders and contractors will also not be discriminated against on the grounds of sex, age, disability, low-income level, creed/religion, or limited English proficiency in consideration for an award.”

4. Physically incorporate the FHWA-1273, in its entirety, into all subcontracts and subsequent lower tier subcontracts on Federal-aid highway construction contracts only.
  5. Provide language assistance services (i.e., written translation and oral interpretation), free of charge, to LEP employees and applicants. Contact NCDOT OCR for further assistance, if needed.
  6. For assistance with these Title VI requirements, contact the NCDOT Title VI Nondiscrimination Program at 1-800-522-0453.
- (b) Subrecipients (e.g. cities, counties, LGAs, planning organizations) may be required to prepare and submit a Title VI Plan to NCDOT, including Title VI Assurances and/or agreements. Subrecipients must also ensure compliance by their contractors and subrecipients with Title VI. (23 CFR 200.9(b)(7))
- (c) If reviewed or investigated by NCDOT, the contractor or subrecipient agrees to take affirmative action to correct any deficiencies found within a reasonable time period, not to exceed 90 calendar days, unless additional time is granted by NCDOT. (23 CFR 200.9(b)(15))
- (d) The Contractor is responsible for notifying subcontractors of NCDOT’s External Discrimination Complaints Process.
1. Applicability  
Title VI and related laws protect participants and beneficiaries (e.g., members of the public and contractors) from discrimination by NCDOT employees, subrecipients and contractors, regardless of funding source.
  2. Eligibility  
Any person—or class of persons—who believes he/she has been subjected to discrimination based on race, color, national origin, Limited English Proficiency (LEP), sex, age, or disability (and religion in the context of employment, aviation, or transit) may file a written complaint. The law also prohibits intimidation or retaliation of any sort.
  3. Time Limits and Filing Options  
Complaints may be filed by the affected individual(s) or a representative and must be filed no later than 180 calendar days after the following:
    - (i) The date of the alleged act of discrimination; or
    - (ii) The date when the person(s) became aware of the alleged discrimination; or
    - (iii) Where there has been a continuing course of conduct, the date on which that conduct was discontinued or the latest instance of the conduct.Title VI and related discrimination complaints may be submitted to the following entities:

- North Carolina Department of Transportation, Office of Civil Rights, Title VI Program, 1511 Mail Service Center, Raleigh, NC 27699-1511; toll free 1-800-522-0453
  - Federal Highway Administration, North Carolina Division Office, 310 New Bern Avenue, Suite 410, Raleigh, NC 27601, 919-747-7010
  - US Department of Transportation, Departmental Office of Civil Rights, External Civil Rights Programs Division, 1200 New Jersey Avenue, SE, Washington, DC 20590; 202-366-4070
4. Format for Complaints  
Complaints must be in writing and signed by the complainant(s) or a representative, and include the complainant's name, address, and telephone number. Complaints received by fax or e-mail will be acknowledged and processed. Allegations received by telephone will be reduced to writing and provided to the complainant for confirmation or revision before processing. Complaints will be accepted in other languages, including Braille.
5. Discrimination Complaint Form  
Contact NCDOT Civil Rights to receive a full copy of the Discrimination Complaint Form and procedures.
6. Complaint Basis  
Allegations must be based on issues involving race, color, national origin (LEP), sex, age, disability, or religion (in the context of employment, aviation or transit). "Basis" refers to the complainant's membership in a protected group category.

**TABLE 103-1  
COMPLAINT BASIS**

Protected Categories	Definition	Examples	Applicable Nondiscrimination Authorities
Race and Ethnicity	An individual belonging to one of the accepted racial groups; or the perception, based usually on physical characteristics that a person is a member of a racial group	Black/African American, Hispanic/Latino, Asian, American Indian/Alaska Native, Native Hawaiian/Pacific Islander, White	Title VI of the Civil Rights Act of 1964; 49 CFR Part 21; 23 CFR 200; 49 U.S.C. 5332(b); 49 U.S.C. 47123. ( <i>Executive Order 13166</i> )
Color	Color of skin, including shade of skin within a racial group	Black, White, brown, yellow, etc.	
National Origin ( <i>Limited English Proficiency</i> )	Place of birth. Citizenship is not a factor. ( <i>Discrimination based on language or a person's accent is also covered</i> )	Mexican, Cuban, Japanese, Vietnamese, Chinese	
Sex	Gender. The sex of an individual. <i>Note: Sex under this program does not include sexual orientation.</i>	Women and Men	1973 Federal-Aid Highway Act; 49 U.S.C. 5332(b); 49 U.S.C. 47123.
Age	Persons of any age	21-year-old person	Age Discrimination Act of 1975 49 U.S.C. 5332(b); 49 U.S.C. 47123.
Disability	Physical or mental impairment, permanent or temporary, or perceived.	Blind, alcoholic, para-amputee, epileptic, diabetic, arthritic	Section 504 of the Rehabilitation Act of 1973; Americans with Disabilities Act of 1990

<p>Religion (in the context of employment) <i>(Religion/ Creed in all aspects of any aviation or transit-related construction)</i></p>	<p>An individual belonging to a religious group; or the perception, based on distinguishable characteristics that a person is a member of a religious group. In practice, actions taken as a result of the moral and ethical beliefs as to what is right and wrong, which are sincerely held with the strength of traditional religious views. <b>Note:</b> Does not have to be associated with a recognized religious group or church; if an individual sincerely holds to the belief, it is a protected religious practice.</p>	<p>Muslim, Christian, Sikh, Hindu, etc.</p>	<p>Title VII of the Civil Rights Act of 1964; 23 CFR 230; FHWA-1273 Required Contract Provisions. <i>(49 U.S.C. 5332(b); 49 U.S.C. 47123)</i></p>
--	---	---	---

### (3) Pertinent Nondiscrimination Authorities

During the performance of this contract, the contractor, for itself, its assignees, and successors in interest agrees to comply with the following non-discrimination statutes and authorities, including, but not limited to:

- (a) Title VI of the Civil Rights Act of 1964 (42 U.S.C. § 2000d et seq., 78 stat. 252), (prohibits discrimination on the basis of race, color, national origin); and 49 CFR Part 21.
- (b) The Uniform Relocation Assistance and Real Property Acquisition Policies Act of 1970, (42 U.S.C. § 4601), (prohibits unfair treatment of persons displaced or whose property has been acquired because of Federal or Federal-aid programs and projects);
- (c) Federal-Aid Highway Act of 1973, (23 U.S.C. § 324 et seq.), (prohibits discrimination on the basis of sex);
- (d) Section 504 of the Rehabilitation Act of 1973, (29 U.S.C. § 794 et seq.), as amended, (prohibits discrimination on the basis of disability) and 49 CFR Part 27;
- (e) The Age Discrimination Act of 1975, as amended, (42 U.S.C. § 6101 et seq.), (prohibits discrimination on the basis of age);
- (f) Airport and Airway Improvement Act of 1982, (49 USC § 471, Section 47123), as amended, (prohibits discrimination based on race, creed, color, national origin, or sex);
- (g) The Civil Rights Restoration Act of 1987, (PL 100-209), (Broadened the scope, coverage and applicability of Title VI of the Civil Rights Act of 1964, The Age Discrimination Act of 1975 and Section 504 of the Rehabilitation Act of 1973, by expanding the definition of the terms "programs or activities" to include all of the programs or activities of the Federal-aid recipients, sub-recipients and contractors, whether such programs or activities are Federally funded or not);
- (h) Titles II and III of the Americans with Disabilities Act, which prohibit discrimination on the basis of disability in the operation of public entities, public and private transportation systems, places of public accommodation, and certain testing entities (42 U.S.C. §§ 12131-12189) as implemented by Department of Transportation regulations at 49 C.F.R. parts 37 and 38;
- (i) The Federal Aviation Administration's Nondiscrimination statute (49 U.S.C. § 47123) (prohibits discrimination on the basis of race, color, national origin, and sex);
- (j) Executive Order 12898, Federal Actions to Address Environmental Justice in Minority Populations and Low-Income Populations, which ensures Nondiscrimination against minority populations by discouraging programs, policies, and activities with

- disproportionately high and adverse human health or environmental effects on minority and low-income populations;
- (k) Executive Order 13166, Improving Access to Services for Persons with Limited English Proficiency, and resulting agency guidance, national origin discrimination includes discrimination because of Limited English proficiency (LEP). To ensure compliance with Title VI, you must take reasonable steps to ensure that LEP persons have meaningful access to your programs (70 Fed. Reg. at 74087 to 74100);
  - (l) Title IX of the Education Amendments of 1972, as amended, which prohibits you from discriminating because of sex in education programs or activities (20 U.S.C. 1681 et seq).
  - (m) Title VII of the Civil Rights Act of 1964 (42 U.S.C. § 2000e et seq., Pub. L. 88-352), (prohibits employment discrimination on the basis of race, color, religion, sex, or national origin).
- (4) **Additional Title VI Assurances**

*\*\*The following Title VI Assurances (Appendices B, C and D) shall apply, as applicable*

- (a) Clauses for Deeds Transferring United States Property (1050.2A, Appendix B)  
The following clauses will be included in deeds effecting or recording the transfer of real property, structures, or improvements thereon, or granting interest therein from the United States pursuant to the provisions of Assurance 4.

NOW, THEREFORE, the U.S. Department of Transportation as authorized by law and upon the condition that the North Carolina Department of Transportation (NCDOT) will accept title to the lands and maintain the project constructed thereon in accordance with the North Carolina General Assembly, the Regulations for the Administration of the Federal-Aid Highway Program, and the policies and procedures prescribed by the Federal Highway Administration of the U.S. Department of Transportation in accordance and in compliance with all requirements imposed by Title 49, Code of Federal Regulations, U.S. Department of Transportation, Subtitle A, Office of the Secretary, Part 21, Nondiscrimination in Federally-assisted programs of the U.S. Department of Transportation pertaining to and effectuating the provisions of Title VI of the Civil Rights Act of 1964 (78 Stat. 252; 42 U.S.C. § 2000d to 2000d-4), does hereby remise, release, quitclaim and convey unto the NCDOT all the right, title and interest of the U.S. Department of Transportation in and to said lands described in Exhibit A attached hereto and made a part hereof.

(HABENDUM CLAUSE)

TO HAVE AND TO HOLD said lands and interests therein unto the North Carolina Department of Transportation (NCDOT) and its successors forever, subject, however, to the covenants, conditions, restrictions and reservations herein contained as follows, which will remain in effect for the period during which the real property or structures are used for a purpose for which Federal financial assistance is extended or for another purpose involving the provision of similar services or benefits and will be binding on the NCDOT, its successors and assigns.

The NCDOT, in consideration of the conveyance of said lands and interests in lands, does hereby covenant and agree as a covenant running with the land for itself, its successors and assigns, that (1) no person will on the grounds of race, color, or national origin, be excluded from participation in, be denied the benefits of, or be otherwise subjected to discrimination with regard to any facility located wholly or in part on, over, or under such lands hereby conveyed [,] [and]\* (2) that the NCDOT will use the lands and interests in lands and interests in lands so conveyed, in compliance with all requirements imposed by or pursuant to Title 49, Code of Federal Regulations, U.S. Department of Transportation, Subtitle A, Office of the Secretary, Part 21, Non-discrimination in Federally-assisted programs of the U.S. Department of Transportation, Effectuation of Title VI of the Civil Rights Act of 1964, and as said Regulations and Acts may be amended [, and (3) that in the event of breach of any of the above-mentioned nondiscrimination conditions, the Department will have a right to enter or re-enter said lands and facilities on said land, and that above described land and facilities will thereon revert to and vest in and become the absolute property of the U.S. Department of Transportation and its assigns as such interest existed prior to this instruction].\*

(\*Reverter clause and related language to be used only when it is determined that such a clause is necessary in order to make clear the purpose of Title VI.)

(b) Clauses for Transfer of Real Property Acquired or Improved Under the Activity, Facility, or Program (1050.2A, Appendix C)

The following clauses will be included in deeds, licenses, leases, permits, or similar instruments entered into by the North Carolina Department of Transportation (NCDOT) pursuant to the provisions of Assurance 7(a):

1. The (grantee, lessee, permittee, etc. as appropriate) for himself/herself, his/her heirs, personal representatives, successors in interest, and assigns, as a part of the consideration hereof, does hereby covenant and agree [in the case of deeds and leases add "as a covenant running with the land"] that:
  - (i.) In the event facilities are constructed, maintained, or otherwise operated on the property described in this (deed, license, lease, permit, etc.) for a purpose for which a U.S. Department of Transportation activity, facility, or program is extended or for another purpose involving the provision of similar services or benefits, the (grantee, licensee, lessee, permittee, etc.) will maintain and operate such facilities and services in compliance with all requirements imposed by the Acts and Regulations (as may be amended) such that no person on the grounds of race, color, or national origin, will be excluded from participation in, denied the benefits of, or be otherwise subjected to discrimination in the use of said facilities.
2. With respect to licenses, leases, permits, etc., in the event of breach of any of the above Nondiscrimination covenants, the NCDOT will have the right to terminate the (lease, license, permit, etc.) and to enter, re-enter, and repossess said lands and facilities thereon, and hold the same as if the (lease, license, permit, etc.) had never been made or issued. \*
3. With respect to a deed, in the event of breach of any of the above Nondiscrimination covenants, the NCDOT will have the right to enter or re-enter the lands and facilities thereon, and the above described lands and facilities will there upon revert to and vest in and become the absolute property of the NCDOT and its assigns. \*

(\*Reverter clause and related language to be used only when it is determined that such a clause is necessary to make clear the purpose of Title VI.)

(c) Clauses for Construction/Use/Access to Real Property Acquired Under the Activity, Facility or Program (1050.2A, Appendix D)

The following clauses will be included in deeds, licenses, permits, or similar instruments/ agreements entered into by the North Carolina Department of Transportation (NCDOT) pursuant to the provisions of Assurance 7(b):

1. The (grantee, licensee, permittee, etc., as appropriate) for himself/herself, his/her heirs, personal representatives, successors in interest, and assigns, as a part of the consideration hereof, does hereby covenant and agree (in the case of deeds and leases add, "as a covenant running with the land") that (1) no person on the ground of race, color, or national origin, will be excluded from participation in, denied the benefits of, or be otherwise subjected to discrimination in the use of said facilities, (2) that in the construction of any improvements on, over, or under such land, and the furnishing of services thereon, no person on the ground of race, color, or national origin, will be excluded from participation in, denied the benefits of, or otherwise be subjected to discrimination, (3) that the (grantee, licensee, lessee, permittee, etc.) will use the premises in compliance with all other requirements imposed by or pursuant to the Acts and Regulations, as amended, set forth in this Assurance.
2. With respect to (licenses, leases, permits, etc.), in the event of breach of any of the above Non-discrimination covenants, the NCDOT will have the right to terminate the (license, permit, etc., as appropriate) and to enter or re-enter and repossess said land and the facilities thereon, and hold the same as if said (license, permit, etc., as appropriate) had never been made or issued. \*
3. With respect to deeds, in the event of breach of any of the above Nondiscrimination covenants, the NCDOT will there upon revert to and vest in and become the absolute property of the NCDOT and its assigns. \*

(\*Reverter clause and related language to be used only when it is determined that such a clause is necessary to make clear the purpose of Title VI.)

**STANDARD SPECIAL PROVISION****MINORITY AND FEMALE EMPLOYMENT REQUIREMENTS**

Z-7

NOTICE OF REQUIREMENTS FOR AFFIRMATIVE ACTION TO ENSURE EQUAL EMPLOYMENT OPPORTUNITY (*EXECUTIVE NUMBER 11246*)

1. The goals and timetables for minority and female participation, expressed in percentage terms for the Contractor's aggregate workforce in each trade on all construction work in the covered area, see as shown on the attached sheet entitled "Employment Goals for Minority and Female participation".

These goals are applicable to all the Contractor's construction work (whether or not it is Federal or federally assisted) performed in the covered area. If the Contractor performs construction work in a geographical area located outside of the covered area, it shall apply the goals established for such geographical area where the work is actually performed. With regard to this second area, the Contractor also is subject to the goals for both its federally involved and nonfederally involved construction.

The Contractor's compliance with the Executive Order and the regulations in *41 CFR Part 60-4* shall be based on its implementation of the Equal Opportunity Clause, specific affirmative action obligations required by the specifications set forth in *41 CFR 60-4.3(a)*, and its effort to meet the goals. The hours of minority and female employment and training must be substantially uniform throughout the length of the contract, and in each trade and the Contractor shall make a good faith effort to employ minorities and women evenly on each of its projects. The transfer of minority or female employees or trainees from Contractor to Contractor or from project to project for the sole purpose of meeting the Contractor's goals shall be a violation of the contract, the executive Order and the regulations in *41 CFR Part 60-4*. Compliance with the goals will be measured against the total work hours performed.

2. As used in this Notice and in the contract resulting from this solicitation, the "covered area" is the county or counties shown on the cover sheet of the proposal form and contract.



**EMPLOYMENT GOALS FOR MINORITY  
AND FEMALE PARTICIPATION**

Economic Areas

**Area 023 29.7%**

Bertie County  
Camden County  
Chowan County  
Gates County  
Hertford County  
Pasquotank County  
Perquimans County

**Area 024 31.7%**

Beaufort County  
Carteret County  
Craven County  
Dare County  
Edgecombe County  
Green County  
Halifax County  
Hyde County  
Jones County  
Lenoir County  
Martin County  
Nash County  
Northampton County  
Pamlico County  
Pitt County  
Tyrrell County  
Washington County  
Wayne County  
Wilson County

**Area 025 23.5%**

Columbus County  
Duplin County  
Onslow County  
Pender County

**Area 026 33.5%**

Bladen County  
Hoke County  
Richmond County  
Robeson County  
Sampson County  
Scotland County

**Area 027 24.7%**

Chatham County  
Franklin County  
Granville County  
Harnett County  
Johnston County  
Lee County  
Person County  
Vance County  
Warren County

**Area 028 15.5%**

Alleghany County  
Ashe County  
Caswell County  
Davie County  
Montgomery County  
Moore County  
Rockingham County  
Surry County  
Watauga County  
Wilkes County

**Area 029 15.7%**

Alexander County  
Anson County  
Burke County  
Cabarrus County  
Caldwell County  
Catawba County  
Cleveland County  
Iredell County  
Lincoln County  
Polk County  
Rowan County  
Rutherford County  
Stanly County

**Area 0480 8.5%**

Buncombe County  
Madison County

**Area 030 6.3%**

Avery County  
Cherokee County  
Clay County  
Graham County  
Haywood County  
Henderson County  
Jackson County  
McDowell County  
Macon County  
Mitchell County  
Swain County  
Transylvania County  
Yancey County

**SMSA Areas**

**Area 5720 26.6%**

Currituck County

**Area 9200 20.7%**

Brunswick County

New Hanover County

**Area 2560 24.2%**

Cumberland County

**Area 6640 22.8%**

Durham County

Orange County

Wake County

**Area 1300 16.2%**

Alamance County

**Area 3120 16.4%**

Davidson County

Forsyth County

Guilford County

Randolph County

Stokes County

Yadkin County

**Area 1520 18.3%**

Gaston County

Mecklenburg County

Union County

---

**Goals for Female**

**Participation in Each Trade**

(Statewide) 6.9%

**STANDARD SPECIAL PROVISION****(b) REQUIRED CONTRACT PROVISIONS FEDERAL - AID CONSTRUCTION CONTRACTS**

FHWA - 1273 Electronic Version - May 1, 2012

Z-8

- I. General
- II. Nondiscrimination
- III. Nonsegregated Facilities
- IV. Davis-Bacon and Related Act Provisions
- V. Contract Work Hours and Safety Standards Act Provisions
- VI. Subletting or Assigning the Contract
- VII. Safety: Accident Prevention
- VIII. False Statements Concerning Highway Projects
- IX. Implementation of Clean Air Act and Federal Water Pollution Control Act
- X. Compliance with Governmentwide Suspension and Debarment Requirements
- XI. Certification Regarding Use of Contract Funds for Lobbying

**ATTACHMENTS**

- A. Employment and Materials Preference for Appalachian Development Highway System or Appalachian Local Access Road Contracts (included in Appalachian contracts only)

**I. GENERAL**

1. Form FHWA-1273 must be physically incorporated in each construction contract funded under Title 23 (excluding emergency contracts solely intended for debris removal). The contractor (or subcontractor) must insert this form in each subcontract and further require its inclusion in all lower tier subcontracts (excluding purchase orders, rental agreements and other agreements for supplies or services).

The applicable requirements of Form FHWA-1273 are incorporated by reference for work done under any purchase order, rental agreement or agreement for other services. The prime contractor shall be responsible for compliance by any subcontractor, lower-tier subcontractor or service provider.

Form FHWA-1273 must be included in all Federal-aid design-build contracts, in all subcontracts and in lower tier subcontracts (excluding subcontracts for design services, purchase orders, rental agreements and other agreements for supplies or services). The design-builder shall be responsible for compliance by any subcontractor, lower-tier subcontractor or service provider.

Contracting agencies may reference Form FHWA-1273 in bid proposal or request for proposal documents, however, the Form FHWA-1273 must be physically incorporated (not referenced) in all contracts, subcontracts and lower-tier subcontracts (excluding purchase orders, rental agreements and other agreements for supplies or services related to a construction contract).

2. Subject to the applicability criteria noted in the following sections, these contract provisions shall apply to all work performed on the contract by the contractor's own organization and with the assistance of workers under the contractor's immediate superintendence and to all work performed on the contract by piecework, station work, or by subcontract.
3. A breach of any of the stipulations contained in these Required Contract Provisions may be sufficient grounds for withholding of progress payments, withholding of final payment, termination of the contract, suspension / debarment or any other action determined to be appropriate by the contracting agency and FHWA.
4. Selection of Labor: During the performance of this contract, the contractor shall not use convict labor for any purpose within the limits of a construction project on a Federal-aid highway unless it is labor performed by convicts who are on parole, supervised release, or probation. The term Federal-aid highway does not include roadways functionally classified as local roads or rural minor collectors.

**II. NONDISCRIMINATION**

The provisions of this section related to 23 CFR Part 230 are applicable to all Federal-aid construction contracts and to all related construction subcontracts of \$10,000 or more. The provisions of 23 CFR Part 230 are not applicable to material supply, engineering, or architectural service contracts.

In addition, the contractor and all subcontractors must comply with the following policies: Executive Order 11246, 41 CFR 60, 29 CFR 1625-1627, Title 23 USC Section 140, the Rehabilitation Act of 1973, as amended (29 USC 794), Title VI of the Civil Rights Act of 1964, as amended, and related regulations including 49 CFR Parts 21, 26 and 27; and 23 CFR Parts 200, 230, and 633.

The contractor and all subcontractors must comply with: the requirements of the Equal Opportunity Clause in 41 CFR 60-1.4(b) and, for all construction contracts exceeding \$10,000, the Standard Federal Equal Employment Opportunity Construction Contract Specifications in 41 CFR 60-4.3.

Note: The U.S. Department of Labor has exclusive authority to determine compliance with Executive Order 11246 and the policies of the Secretary of Labor including 41 CFR 60, and 29 CFR 1625-1627. The contracting agency and the FHWA have the authority and the responsibility to ensure compliance with Title 23 USC Section 140, the Rehabilitation Act of 1973, as amended (29 USC 794), and Title VI of the Civil Rights Act of 1964, as amended, and related regulations including 49 CFR Parts 21, 26 and 27; and 23 CFR Parts 200, 230, and 633.

The following provision is adopted from 23 CFR 230, Appendix A, with appropriate revisions to conform to the U.S. Department of Labor (US DOL) and FHWA requirements.

1. **Equal Employment Opportunity:** Equal employment opportunity (EEO) requirements not to discriminate and to take affirmative action to assure equal opportunity as set forth under laws, executive orders, rules, regulations (28 CFR 35, 29 CFR 1630, 29 CFR 1625-1627, 41 CFR 60 and 49 CFR 27) and orders of the Secretary of Labor as modified by the provisions prescribed herein, and imposed pursuant to 23 U.S.C. 140 shall constitute the EEO and specific affirmative action standards for the contractor's project activities under this contract. The provisions of the Americans with Disabilities Act of 1990 (42 U.S.C. 12101 et seq.) set forth under 28 CFR 35 and 29 CFR 1630 are incorporated by reference in this contract. In the execution of this contract, the contractor agrees to comply with the following minimum specific requirement activities of EEO:
  - a. The contractor will work with the contracting agency and the Federal Government to ensure that it has made every good faith effort to provide equal opportunity with respect to all of its terms and conditions of employment and in their review of activities under the contract.

- b. The contractor will accept as its operating policy the following statement:  
"It is the policy of this Company to assure that applicants are employed, and that employees are treated during employment, without regard to their race, religion, sex, color, national origin, age or disability. Such action shall include: employment, upgrading, demotion, or transfer; recruitment or recruitment advertising; layoff or termination; rates of pay or other forms of compensation; and selection for training, including apprenticeship, pre-apprenticeship, and/or on-the-job training."
2. **EEO Officer:** The contractor will designate and make known to the contracting officers an EEO Officer who will have the responsibility for and must be capable of effectively administering and promoting an active EEO program and who must be assigned adequate authority and responsibility to do so.
3. **Dissemination of Policy:** All members of the contractor's staff who are authorized to hire, supervise, promote, and discharge employees, or who recommend such action, or who are substantially involved in such action, will be made fully cognizant of, and will implement, the contractor's EEO policy and contractual responsibilities to provide EEO in each grade and classification of employment. To ensure that the above agreement will be met, the following actions will be taken as a minimum:
  - a. Periodic meetings of supervisory and personnel office employees will be conducted before the start of work and then not less often than once every six months, at which time the contractor's EEO policy and its implementation will be reviewed and explained. The meetings will be conducted by the EEO Officer.
  - b. All new supervisory or personnel office employees will be given a thorough indoctrination by the EEO Officer, covering all major aspects of the contractor's EEO obligations within thirty days following their reporting for duty with the contractor.
  - c. All personnel who are engaged in direct recruitment for the project will be instructed by the EEO Officer in the contractor's procedures for locating and hiring minorities and women.
  - d. Notices and posters setting forth the contractor's EEO policy will be placed in areas readily accessible to employees, applicants for employment and potential employees.
  - e. The contractor's EEO policy and the procedures to implement such policy will be brought to the attention of employees by means of meetings, employee handbooks, or other appropriate means.
4. **Recruitment:** When advertising for employees, the contractor will include in all advertisements for employees the notation: "An Equal Opportunity Employer." All such advertisements will be placed in publications having a large circulation among minorities and women in the area from which the project work force would normally be derived.
  - a. The contractor will, unless precluded by a valid bargaining agreement, conduct systematic and direct recruitment through public and private employee referral sources likely to yield qualified minorities and women. To meet this requirement, the contractor will identify sources of potential minority group employees, and establish with such identified sources procedures whereby minority and women applicants may be referred to the contractor for employment consideration.
  - b. In the event the contractor has a valid bargaining agreement providing for exclusive hiring hall referrals, the contractor is expected to observe the provisions of that agreement to the extent that the system meets the contractor's compliance with EEO contract provisions. Where implementation of such an agreement has the effect of discriminating against minorities or women, or obligates the contractor to do the same, such implementation violates Federal nondiscrimination provisions.
  - c. The contractor will encourage its present employees to refer minorities and women as applicants for employment. Information and procedures with regard to referring such applicants will be discussed with employees.
5. **Personnel Actions:** Wages, working conditions, and employee benefits shall be established and administered, and personnel actions of every type, including hiring, upgrading, promotion, transfer, demotion, layoff, and termination, shall be taken without regard to race, color, religion, sex, national origin, age or disability. The following procedures shall be followed:
  - a. The contractor will conduct periodic inspections of project sites to insure that working conditions and employee facilities do not indicate discriminatory treatment of project site personnel.
  - b. The contractor will periodically evaluate the spread of wages paid within each classification to determine any evidence of discriminatory wage practices.
  - c. The contractor will periodically review selected personnel actions in depth to determine whether there is evidence of discrimination. Where evidence is found, the contractor will promptly take corrective action. If the review indicates that the discrimination may extend beyond the actions reviewed, such corrective action shall include all affected persons.
  - d. The contractor will promptly investigate all complaints of alleged discrimination made to the contractor in connection with its obligations under this contract, will attempt to resolve such complaints, and will take appropriate corrective action within a reasonable time. If the investigation indicates that the discrimination may affect persons other than the complainant, such corrective action shall include such other persons. Upon completion of each investigation, the contractor will inform every complainant of all of their avenues of appeal.
6. **Training and Promotion:**
  - a. The contractor will assist in locating, qualifying, and increasing the skills of minorities and women who are applicants for employment or current employees. Such efforts should be aimed at developing full journey level status employees in the type of trade or job classification involved.
  - b. Consistent with the contractor's work force requirements and as permissible under Federal and State regulations, the contractor shall make full use of training programs, i.e., apprenticeship, and on-the-job training programs for the geographical area of contract performance. In the event a special provision for training is provided under this contract, this subparagraph will be superseded as indicated in the special provision. The contracting agency may reserve training positions for persons who receive welfare assistance in accordance with 23 U.S.C. 140(a).
  - c. The contractor will advise employees and applicants for employment of available training programs and entrance requirements for each.
  - d. The contractor will periodically review the training and promotion potential of employees who are minorities and women and will encourage eligible employees to apply for such training and promotion.
7. **Unions:** If the contractor relies in whole or in part upon unions as a source of employees, the contractor will use good faith efforts to obtain the cooperation of such unions to increase opportunities for minorities and women. Actions by the contractor, either directly or through a contractor's association acting as agent, will include the procedures set forth below:
  - a. The contractor will use good faith efforts to develop, in cooperation with the unions, joint training programs aimed toward qualifying more minorities and women for membership in the unions and increasing the skills of minorities and women so that they may qualify for higher paying employment.
  - b. The contractor will use good faith efforts to incorporate an EEO clause into each union agreement to the end that such union will be contractually bound to refer applicants without regard to their race, color, religion, sex, national origin, age or disability.
  - c. The contractor is to obtain information as to the referral practices and policies of the labor union except that to the extent such information is within the exclusive possession of the labor union and such labor union refuses to furnish such information to the contractor, the contractor shall so certify to the contracting agency and shall set forth what efforts have been made to obtain such information.

- d. In the event the union is unable to provide the contractor with a reasonable flow of referrals within the time limit set forth in the collective bargaining agreement, the contractor will, through independent recruitment efforts, fill the employment vacancies without regard to race, color, religion, sex, national origin, age or disability; making full efforts to obtain qualified and/or qualifiable minorities and women. The failure of a union to provide sufficient referrals (even though it is obligated to provide exclusive referrals under the terms of a collective bargaining agreement) does not relieve the contractor from the requirements of this paragraph. In the event the union referral practice prevents the contractor from meeting the obligations pursuant to Executive Order 11246, as amended, and these special provisions, such contractor shall immediately notify the contracting agency.
8. **Reasonable Accommodation for Applicants / Employees with Disabilities:** The contractor must be familiar with the requirements for and comply with the Americans with Disabilities Act and all rules and regulations established there under. Employers must provide reasonable accommodation in all employment activities unless to do so would cause an undue hardship.
9. **Selection of Subcontractors, Procurement of Materials and Leasing of Equipment:** The contractor shall not discriminate on the grounds of race, color, religion, sex, national origin, age or disability in the selection and retention of subcontractors, including procurement of materials and leases of equipment. The contractor shall take all necessary and reasonable steps to ensure nondiscrimination in the administration of this contract.
- The contractor shall notify all potential subcontractors and suppliers and lessors of their EEO obligations under this contract.
  - The contractor will use good faith efforts to ensure subcontractor compliance with their EEO obligations.
10. **Assurance Required by 49 CFR 26.13(b):**
- The requirements of 49 CFR Part 26 and the State DOT's U.S. DOT-approved DBE program are incorporated by reference.
  - The contractor or subcontractor shall not discriminate on the basis of race, color, national origin, or sex in the performance of this contract. The contractor shall carry out applicable requirements of 49 CFR Part 26 in the award and administration of DOT-assisted contracts. Failure by the contractor to carry out these requirements is a material breach of this contract, which may result in the termination of this contract or such other remedy as the contracting agency deems appropriate.
11. **Records and Reports:** The contractor shall keep such records as necessary to document compliance with the EEO requirements. Such records shall be retained for a period of three years following the date of the final payment to the contractor for all contract work and shall be available at reasonable times and places for inspection by authorized representatives of the contracting agency and the FHWA.
- The records kept by the contractor shall document the following:
    - The number and work hours of minority and non-minority group members and women employed in each work classification on the project;
    - The progress and efforts being made in cooperation with unions, when applicable, to increase employment opportunities for minorities and women; and
    - The progress and efforts being made in locating, hiring, training, qualifying, and upgrading minorities and women;
  - The contractors and subcontractors will submit an annual report to the contracting agency each July for the duration of the project, indicating the number of minority, women, and non-minority group employees currently engaged in each work classification required by the contract work. This information is to be reported on Form FHWA-1391. The staffing data should represent the project work force on board in all or any part of the last payroll period preceding the end of July. If on-the-job training is being required by special provision, the contractor will be required to collect and report training data. The employment data should reflect the work force on board during all or any part of the last payroll period preceding the end of July.

### III. NONSEGREGATED FACILITIES

This provision is applicable to all Federal-aid construction contracts and to all related construction subcontracts of \$10,000 or more.

The contractor must ensure that facilities provided for employees are provided in such a manner that segregation on the basis of race, color, religion, sex, or national origin cannot result. The contractor may neither require such segregated use by written or oral policies nor tolerate such use by employee custom. The contractor's obligation extends further to ensure that its employees are not assigned to perform their services at any location, under the contractor's control, where the facilities are segregated. The term "facilities" includes waiting rooms, work areas, restaurants and other eating areas, time clocks, restrooms, washrooms, locker rooms, and other storage or dressing areas, parking lots, drinking fountains, recreation or entertainment areas, transportation, and housing provided for employees. The contractor shall provide separate or single-user restrooms and necessary dressing or sleeping areas to assure privacy between sexes.

### IV. DAVIS-BACON AND RELATED ACT PROVISIONS

This section is applicable to all Federal-aid construction projects exceeding \$2,000 and to all related subcontracts and lower-tier subcontracts (regardless of subcontract size). The requirements apply to all projects located within the right-of-way of a roadway that is functionally classified as Federal-aid highway. This excludes roadways functionally classified as local roads or rural minor collectors, which are exempt. Contracting agencies may elect to apply these requirements to other projects.

The following provisions are from the U.S. Department of Labor regulations in 29 CFR 5.5 "Contract provisions and related matters" with minor revisions to conform to the FHWA-1273 format and FHWA program requirements.

#### 1. Minimum wages

- All laborers and mechanics employed or working upon the site of the work, will be paid unconditionally and not less often than once a week, and without subsequent deduction or rebate on any account (except such payroll deductions as are permitted by regulations issued by the Secretary of Labor under the Copeland Act (29 CFR part 3)), the full amount of wages and bona fide fringe benefits (or cash equivalents thereof) due at time of payment computed at rates not less than those contained in the wage determination of the Secretary of Labor which is attached hereto and made a part hereof, regardless of any contractual relationship which may be alleged to exist between the contractor and such laborers and mechanics.

Contributions made or costs reasonably anticipated for bona fide fringe benefits under section 1(b)(2) of the Davis-Bacon Act on behalf of laborers or mechanics are considered wages paid to such laborers or mechanics, subject to the provisions of paragraph 1.d. of this section; also, regular contributions made or costs incurred for more than a weekly period (but not less often than quarterly) under plans, funds, or programs which cover the particular weekly period, are deemed to be constructively made or incurred during such weekly period. Such laborers and mechanics shall be paid the appropriate wage rate and fringe benefits on the wage determination for the classification of work actually performed, without regard to skill, except as provided in 29 CFR 5.5(a)(4). Laborers or mechanics performing work in more than one classification may be compensated at the rate specified for each classification for the time actually worked therein: Provided, That the employer's payroll records accurately set forth the time spent in each classification in which work is performed. The wage determination (including any additional classification and wage rates conformed under paragraph 1.b. of this section) and the Davis-Bacon poster (WH-1321) shall be posted at all times by the contractor and its subcontractors at the site of the work in a prominent and accessible place where it can be easily seen by the workers.

- b. (1) The contracting officer shall require that any class of laborers or mechanics, including helpers, which is not listed in the wage determination and which is to be employed under the contract shall be classified in conformance with the wage determination. The contracting officer shall approve an additional classification and wage rate and fringe benefits therefore only when the following criteria have been met:
    - (i) The work to be performed by the classification requested is not performed by a classification in the wage determination; and
    - (ii) The classification is utilized in the area by the construction industry; and
    - (iii) The proposed wage rate, including any bona fide fringe benefits, bears a reasonable relationship to the wage rates contained in the wage determination.
  - (2) If the contractor and the laborers and mechanics to be employed in the classification (if known), or their representatives, and the contracting officer agree on the classification and wage rate (including the amount designated for fringe benefits where appropriate), a report of the action taken shall be sent by the contracting officer to the Administrator of the Wage and Hour Division, Employment Standards Administration, U.S. Department of Labor, Washington, DC 20210. The Administrator, or an authorized representative, will approve, modify, or disapprove every additional classification action within 30 days of receipt and so advise the contracting officer or will notify the contracting officer within the 30-day period that additional time is necessary.
  - (3) In the event the contractor, the laborers or mechanics to be employed in the classification or their representatives, and the contracting officer do not agree on the proposed classification and wage rate (including the amount designated for fringe benefits, where appropriate), the contracting officer shall refer the questions, including the views of all interested parties and the recommendation of the contracting officer, to the Wage and Hour Administrator for determination. The Wage and Hour Administrator, or an authorized representative, will issue a determination within 30 days of receipt and so advise the contracting officer or will notify the contracting officer within the 30-day period that additional time is necessary.
  - (4) The wage rate (including fringe benefits where appropriate) determined pursuant to paragraphs 1.b.(2) or 1.b.(3) of this section, shall be paid to all workers performing work in the classification under this contract from the first day on which work is performed in the classification.
- c. Whenever the minimum wage rate prescribed in the contract for a class of laborers or mechanics includes a fringe benefit which is not expressed as an hourly rate, the contractor shall either pay the benefit as stated in the wage determination or shall pay another bona fide fringe benefit or an hourly cash equivalent thereof.
  - d. If the contractor does not make payments to a trustee or other third person, the contractor may consider as part of the wages of any laborer or mechanic the amount of any costs reasonably anticipated in providing bona fide fringe benefits under a plan or program, Provided, That the Secretary of Labor has found, upon the written request of the contractor, that the applicable standards of the Davis-Bacon Act have been met. The Secretary of Labor may require the contractor to set aside in a separate account assets for the meeting of obligations under the plan or program.
2. **Withholding.** The contracting agency shall upon its own action or upon written request of an authorized representative of the Department of Labor, withhold or cause to be withheld from the contractor under this contract, or any other Federal contract with the same prime contractor, or any other federally-assisted contract subject to Davis-Bacon prevailing wage requirements, which is held by the same prime contractor, so much of the accrued payments or advances as may be considered necessary to pay laborers and mechanics, including apprentices, trainees, and helpers, employed by the contractor or any subcontractor the full amount of wages required by the contract. In the event of failure to pay any laborer or mechanic, including any apprentice, trainee, or helper, employed or working on the site of the work, all or part of the wages required by the contract, the contracting agency may, after written notice to the contractor, take such action as may be necessary to cause the suspension of any further payment, advance, or guarantee of funds until such violations have ceased.
  3. **Payrolls and basic records**
    - a. Payrolls and basic records relating thereto shall be maintained by the contractor during the course of the work and preserved for a period of three years thereafter for all laborers and mechanics working at the site of the work. Such records shall contain the name, address, and social security number of each such worker, his or her correct classification, hourly rates of wages paid (including rates of contributions or costs anticipated for bona fide fringe benefits or cash equivalents thereof of the types described in section 1(b)(2)(B) of the Davis-Bacon Act), daily and weekly number of hours worked, deductions made and actual wages paid. Whenever the Secretary of Labor has found under 29 CFR 5.5(a)(1)(iv) that the wages of any laborer or mechanic include the amount of any costs reasonably anticipated in providing benefits under a plan or program described in section 1(b)(2)(B) of the Davis-Bacon Act, the contractor shall maintain records which show that the commitment to provide such benefits is enforceable, that the plan or program is financially responsible, and that the plan or program has been communicated in writing to the laborers or mechanics affected, and records which show the costs anticipated or the actual cost incurred in providing such benefits. Contractors employing apprentices or trainees under approved programs shall maintain written evidence of the registration of apprenticeship programs and certification of trainee programs, the registration of the apprentices and trainees, and the ratios and wage rates prescribed in the applicable programs.
    - b. (1) The contractor shall submit weekly for each week in which any contract work is performed a copy of all payrolls to the contracting agency. The payrolls submitted shall set out accurately and completely all of the information required to be maintained under 29 CFR 5.5(a)(3)(i), except that full social security numbers and home addresses shall not be included on weekly transmittals. Instead the payrolls shall only need to include an individually identifying number for each employee ( e.g. , the last four digits of the employee's social security number). The required weekly payroll information may be submitted in any form desired. Optional Form WH-347 is available for this purpose from the Wage and Hour Division Web site at <http://www.dol.gov/esa/whd/forms/wh347instr.htm> or its successor site. The prime contractor is responsible for the submission of copies of payrolls by all subcontractors. Contractors and subcontractors shall maintain the full social security number and current address of each covered worker, and shall provide them upon request to the contracting agency for transmission to the State DOT, the FHWA or the Wage and Hour Division of the Department of Labor for purposes of an investigation or audit of compliance with prevailing wage requirements. It is not a violation of this section for a prime contractor to require a subcontractor to provide addresses and social security numbers to the prime contractor for its own records, without weekly submission to the contracting agency.
    - (2) Each payroll submitted shall be accompanied by a "Statement of Compliance," signed by the contractor or subcontractor or his or her agent who pays or supervises the payment of the persons employed under the contract and shall certify the following:
      - (i) That the payroll for the payroll period contains the information required to be provided under §5.5 (a)(3)(ii) of Regulations, 29 CFR part 5, the appropriate information is being maintained under §5.5 (a)(3)(i) of Regulations, 29 CFR part 5, and that such information is correct and complete;
      - (ii) That each laborer or mechanic (including each helper, apprentice, and trainee) employed on the contract during the payroll period has been paid the full weekly wages earned, without rebate, either directly or indirectly, and that no deductions have been made either directly or indirectly from the full wages earned, other than permissible deductions as set forth in Regulations, 29 CFR part 3;
      - (iii) That each laborer or mechanic has been paid not less than the applicable wage rates and fringe benefits or cash equivalents for the classification of work performed, as specified in the applicable wage determination incorporated into the contract.

- (3) The weekly submission of a properly executed certification set forth on the reverse side of Optional Form WH-347 shall satisfy the requirement for submission of the "Statement of Compliance" required by paragraph 3.b.(2) of this section.
- (4) The falsification of any of the above certifications may subject the contractor or subcontractor to civil or criminal prosecution under section 1001 of title 18 and section 231 of title 31 of the United States Code.
- c. The contractor or subcontractor shall make the records required under paragraph 3.a. of this section available for inspection, copying, or transcription by authorized representatives of the contracting agency, the State DOT, the FHWA, or the Department of Labor, and shall permit such representatives to interview employees during working hours on the job. If the contractor or subcontractor fails to submit the required records or to make them available, the FHWA may, after written notice to the contractor, the contracting agency or the State DOT, take such action as may be necessary to cause the suspension of any further payment, advance, or guarantee of funds. Furthermore, failure to submit the required records upon request or to make such records available may be grounds for debarment action pursuant to 29 CFR 5.12.
4. **Apprentices and trainees**
- a. Apprentices (programs of the USDOL). Apprentices will be permitted to work at less than the predetermined rate for the work they performed when they are employed pursuant to and individually registered in a bona fide apprenticeship program registered with the U.S. Department of Labor, Employment and Training Administration, Office of Apprenticeship Training, Employer and Labor Services, or with a State Apprenticeship Agency recognized by the Office, or if a person is employed in his or her first 90 days of probationary employment as an apprentice in such an apprenticeship program, who is not individually registered in the program, but who has been certified by the Office of Apprenticeship Training, Employer and Labor Services or a State Apprenticeship Agency (where appropriate) to be eligible for probationary employment as an apprentice.
- The allowable ratio of apprentices to journeymen on the job site in any craft classification shall not be greater than the ratio permitted to the contractor as to the entire work force under the registered program. Any worker listed on a payroll at an apprentice wage rate, who is not registered or otherwise employed as stated above, shall be paid not less than the applicable wage rate on the wage determination for the classification of work actually performed. In addition, any apprentice performing work on the job site in excess of the ratio permitted under the registered program shall be paid not less than the applicable wage rate on the wage determination for the work actually performed. Where a contractor is performing construction on a project in a locality other than that in which its program is registered, the ratios and wage rates (expressed in percentages of the journeyman's hourly rate) specified in the contractor's or subcontractor's registered program shall be observed.
- Every apprentice must be paid at not less than the rate specified in the registered program for the apprentice's level of progress, expressed as a percentage of the journeymen hourly rate specified in the applicable wage determination. Apprentices shall be paid fringe benefits in accordance with the provisions of the apprenticeship program. If the apprenticeship program does not specify fringe benefits, apprentices must be paid the full amount of fringe benefits listed on the wage determination for the applicable classification. If the Administrator determines that a different practice prevails for the applicable apprentice classification, fringes shall be paid in accordance with that determination.
- In the event the Office of Apprenticeship Training, Employer and Labor Services, or a State Apprenticeship Agency recognized by the Office, withdraws approval of an apprenticeship program, the contractor will no longer be permitted to utilize apprentices at less than the applicable predetermined rate for the work performed until an acceptable program is approved.
- b. Trainees (programs of the USDOL). Except as provided in 29 CFR 5.16, trainees will not be permitted to work at less than the predetermined rate for the work performed unless they are employed pursuant to and individually registered in a program which has received prior approval, evidenced by formal certification by the U.S. Department of Labor, Employment and Training Administration.
- The ratio of trainees to journeymen on the job site shall not be greater than permitted under the plan approved by the Employment and Training Administration.
- Every trainee must be paid at not less than the rate specified in the approved program for the trainee's level of progress, expressed as a percentage of the journeyman hourly rate specified in the applicable wage determination. Trainees shall be paid fringe benefits in accordance with the provisions of the trainee program. If the trainee program does not mention fringe benefits, trainees shall be paid the full amount of fringe benefits listed on the wage determination unless the Administrator of the Wage and Hour Division determines that there is an apprenticeship program associated with the corresponding journeyman wage rate on the wage determination which provides for less than full fringe benefits for apprentices. Any employee listed on the payroll at a trainee rate who is not registered and participating in a training plan approved by the Employment and Training Administration shall be paid not less than the applicable wage rate on the wage determination for the classification of work actually performed. In addition, any trainee performing work on the job site in excess of the ratio permitted under the registered program shall be paid not less than the applicable wage rate on the wage determination for the work actually performed.
- In the event the Employment and Training Administration withdraws approval of a training program, the contractor will no longer be permitted to utilize trainees at less than the applicable predetermined rate for the work performed until an acceptable program is approved.
- c. Equal employment opportunity. The utilization of apprentices, trainees and journeymen under this part shall be in conformity with the equal employment opportunity requirements of Executive Order 11246, as amended, and 29 CFR part 30.
- d. Apprentices and Trainees (programs of the U.S. DOT). Apprentices and trainees working under apprenticeship and skill training programs which have been certified by the Secretary of Transportation as promoting EEO in connection with Federal-aid highway construction programs are not subject to the requirements of paragraph 4 of this Section IV. The straight time hourly wage rates for apprentices and trainees under such programs will be established by the particular programs. The ratio of apprentices and trainees to journeymen shall not be greater than permitted by the terms of the particular program.
5. **Compliance with Copeland Act requirements.** The contractor shall comply with the requirements of 29 CFR part 3, which are incorporated by reference in this contract.
6. **Subcontracts.** The contractor or subcontractor shall insert Form FHWA-1273 in any subcontracts and also require the subcontractors to include Form FHWA-1273 in any lower tier subcontracts. The prime contractor shall be responsible for the compliance by any subcontractor or lower tier subcontractor with all the contract clauses in 29 CFR 5.5.
7. **Contract termination:** debarment. A breach of the contract clauses in 29 CFR 5.5 may be grounds for termination of the contract, and for debarment as a contractor and a subcontractor as provided in 29 CFR 5.12.
8. **Compliance with Davis-Bacon and Related Act requirements.** All rulings and interpretations of the Davis-Bacon and Related Acts contained in 29 CFR parts 1, 3, and 5 are herein incorporated by reference in this contract.
9. **Disputes concerning labor standards.** Disputes arising out of the labor standards provisions of this contract shall not be subject to the general disputes clause of this contract. Such disputes shall be resolved in accordance with the procedures of the Department of Labor set forth in 29 CFR parts 5, 6, and 7. Disputes within the meaning of this clause include disputes between the contractor (or any of its subcontractors) and the contracting agency, the U.S. Department of Labor, or the employees or their representatives.
10. **Certification of eligibility.**
- a. By entering into this contract, the contractor certifies that neither it (nor he or she) nor any person or firm who has an interest in the contractor's firm is a person or firm ineligible to be awarded Government contracts by virtue of section 3(a) of the Davis-Bacon Act or 29 CFR 5.12(a)(1).

- b. No part of this contract shall be subcontracted to any person or firm ineligible for award of a Government contract by virtue of section 3(a) of the Davis-Bacon Act or 29 CFR 5.12(a)(1).
- c. The penalty for making false statements is prescribed in the U.S. Criminal Code, 18 U.S.C. 1001.

#### V. CONTRACT WORK HOURS AND SAFETY STANDARDS ACT

The following clauses apply to any Federal-aid construction contract in an amount in excess of \$100,000 and subject to the overtime provisions of the Contract Work Hours and Safety Standards Act. These clauses shall be inserted in addition to the clauses required by 29 CFR 5.5(a) or 29 CFR 4.6. As used in this paragraph, the terms laborers and mechanics include watchmen and guards.

1. **Overtime requirements.** No contractor or subcontractor contracting for any part of the contract work which may require or involve the employment of laborers or mechanics shall require or permit any such laborer or mechanic in any workweek in which he or she is employed on such work to work in excess of forty hours in such workweek unless such laborer or mechanic receives compensation at a rate not less than one and one-half times the basic rate of pay for all hours worked in excess of forty hours in such workweek.
2. **Violation; liability for unpaid wages; liquidated damages.** In the event of any violation of the clause set forth in paragraph (1.) of this section, the contractor and any subcontractor responsible therefor shall be liable for the unpaid wages. In addition, such contractor and subcontractor shall be liable to the United States (in the case of work done under contract for the District of Columbia or a territory, to such District or to such territory), for liquidated damages. Such liquidated damages shall be computed with respect to each individual laborer or mechanic, including watchmen and guards, employed in violation of the clause set forth in paragraph (1.) of this section, in the sum of \$10 for each calendar day on which such individual was required or permitted to work in excess of the standard workweek of forty hours without payment of the overtime wages required by the clause set forth in paragraph (1.) of this section.
3. **Withholding for unpaid wages and liquidated damages.** The FHWA or the contacting agency shall upon its own action or upon written request of an authorized representative of the Department of Labor withhold or cause to be withheld, from any moneys payable on account of work performed by the contractor or subcontractor under any such contract or any other Federal contract with the same prime contractor, or any other federally-assisted contract subject to the Contract Work Hours and Safety Standards Act, which is held by the same prime contractor, such sums as may be determined to be necessary to satisfy any liabilities of such contractor or subcontractor for unpaid wages and liquidated damages as provided in the clause set forth in paragraph (2.) of this section.
4. **Subcontracts.** The contractor or subcontractor shall insert in any subcontracts the clauses set forth in paragraph (1.) through (4.) of this section and also a clause requiring the subcontractors to include these clauses in any lower tier subcontracts. The prime contractor shall be responsible for compliance by any subcontractor or lower tier subcontractor with the clauses set forth in paragraphs (1.) through (4.) of this section.

#### VI. SUBLETTING OR ASSIGNING THE CONTRACT

This provision is applicable to all Federal-aid construction contracts on the National Highway System.

1. The contractor shall perform with its own organization contract work amounting to not less than 30 percent (or a greater percentage if specified elsewhere in the contract) of the total original contract price, excluding any specialty items designated by the contracting agency. Specialty items may be performed by subcontract and the amount of any such specialty items performed may be deducted from the total original contract price before computing the amount of work required to be performed by the contractor's own organization (23 CFR 635.116).
  - a. The term "perform work with its own organization" refers to workers employed or leased by the prime contractor, and equipment owned or rented by the prime contractor, with or without operators. Such term does not include employees or equipment of a subcontractor or lower tier subcontractor, agents of the prime contractor, or any other assignees. The term may include payments for the costs of hiring leased employees



from an employee leasing firm meeting all relevant Federal and State regulatory requirements. Leased employees may only be included in this term if the prime contractor meets all of the following conditions:

- (1) the prime contractor maintains control over the supervision of the day-to-day activities of the leased employees;
  - (2) the prime contractor remains responsible for the quality of the work of the leased employees;
  - (3) the prime contractor retains all power to accept or exclude individual employees from work on the project; and
  - (4) the prime contractor remains ultimately responsible for the payment of predetermined minimum wages, the submission of payrolls, statements of compliance and all other Federal regulatory requirements.
- b. "Specialty Items" shall be construed to be limited to work that requires highly specialized knowledge, abilities, or equipment not ordinarily available in the type of contracting organizations qualified and expected to bid or propose on the contract as a whole and in general are to be limited to minor components of the overall contract.
2. The contract amount upon which the requirements set forth in paragraph (1) of Section VI is computed includes the cost of material and manufactured products which are to be purchased or produced by the contractor under the contract provisions.
  3. The contractor shall furnish (a) a competent superintendent or supervisor who is employed by the firm, has full authority to direct performance of the work in accordance with the contract requirements, and is in charge of all construction operations (regardless of who performs the work) and (b) such other of its own organizational resources (supervision, management, and engineering services) as the contracting officer determines is necessary to assure the performance of the contract.
  4. No portion of the contract shall be sublet, assigned or otherwise disposed of except with the written consent of the contracting officer, or authorized representative, and such consent when given shall not be construed to relieve the contractor of any responsibility for the fulfillment of the contract. Written consent will be given only after the contracting agency has assured that each subcontract is evidenced in writing and that it contains all pertinent provisions and requirements of the prime contract.
  5. The 30% self-performance requirement of paragraph (1) is not applicable to design-build contracts; however, contracting agencies may establish their own self-performance requirements.

#### **VII. SAFETY: ACCIDENT PREVENTION**

This provision is applicable to all Federal-aid construction contracts and to all related subcontracts.

1. In the performance of this contract the contractor shall comply with all applicable Federal, State, and local laws governing safety, health, and sanitation (23 CFR 635). The contractor shall provide all safeguards, safety devices and protective equipment and take any other needed actions as it determines, or as the contracting officer may determine, to be reasonably necessary to protect the life and health of employees on the job and the safety of the public and to protect property in connection with the performance of the work covered by the contract.
2. It is a condition of this contract, and shall be made a condition of each subcontract, which the contractor enters into pursuant to this contract, that the contractor and any subcontractor shall not permit any employee, in performance of the contract, to work in surroundings or under conditions which are unsanitary, hazardous or dangerous to his/her health or safety, as determined under construction safety and health standards (29 CFR 1926) promulgated by the Secretary of Labor, in accordance with Section 107 of the Contract Work Hours and Safety Standards Act (40 U.S.C. 3704).
3. Pursuant to 29 CFR 1926.3, it is a condition of this contract that the Secretary of Labor or authorized representative thereof, shall have right of entry to any site of contract performance to inspect or investigate the matter of compliance with the construction safety and health standards and to carry out the duties of the Secretary under Section 107 of the Contract Work Hours and Safety Standards Act (40 U.S.C.3704).

#### **VIII. FALSE STATEMENTS CONCERNING HIGHWAY PROJECTS**

This provision is applicable to all Federal-aid construction contracts and to all related subcontracts.

In order to assure high quality and durable construction in conformity with approved plans and specifications and a high degree of reliability on statements and representations made by engineers, contractors, suppliers, and workers on Federal-aid highway projects, it is essential that all persons concerned with the project perform their functions as carefully, thoroughly, and honestly as possible. Willful falsification, distortion, or misrepresentation with respect to any facts related to the project is a violation of Federal law. To prevent any misunderstanding regarding the seriousness of these and similar acts, Form FHWA-1022 shall be posted on each Federal-aid highway project (23 CFR 635) in one or more places where it is readily available to all persons concerned with the project:

18 U.S.C. 1020 reads as follows:

"Whoever, being an officer, agent, or employee of the United States, or of any State or Territory, or whoever, whether a person, association, firm, or corporation, knowingly makes any false statement, false representation, or false report as to the character, quality, quantity, or cost of the material used or to be used, or the quantity or quality of the work performed or to be performed, or the cost thereof in connection with the submission of plans, maps, specifications, contracts, or costs of construction on any highway or related project submitted for approval to the Secretary of Transportation; or

Whoever knowingly makes any false statement, false representation, false report or false claim with respect to the character, quality, quantity, or cost of any work performed or to be performed, or materials furnished or to be furnished, in connection with the construction of any highway or related project approved by the Secretary of Transportation; or

Whoever knowingly makes any false statement or false representation as to material fact in any statement, certificate, or report submitted pursuant to provisions of the Federal-aid Roads Act approved July 1, 1916, (39 Stat. 355), as amended and supplemented;

Shall be fined under this title or imprisoned not more than 5 years or both."

#### **IX. IMPLEMENTATION OF CLEAN AIR ACT AND FEDERAL WATER POLLUTION CONTROL ACT**

This provision is applicable to all Federal-aid construction contracts and to all related subcontracts.

By submission of this bid/proposal or the execution of this contract, or subcontract, as appropriate, the bidder, proposer, Federal-aid construction contractor, or subcontractor, as appropriate, will be deemed to have stipulated as follows:

1. That any person who is or will be utilized in the performance of this contract is not prohibited from receiving an award due to a violation of Section 508 of the Clean Water Act or Section 306 of the Clean Air Act.
2. That the contractor agrees to include or cause to be included the requirements of paragraph (1) of this Section X in every subcontract, and further agrees to take such action as the contracting agency may direct as a means of enforcing such requirements.

#### **X. CERTIFICATION REGARDING DEBARMENT, SUSPENSION, INELIGIBILITY AND VOLUNTARY EXCLUSION**

This provision is applicable to all Federal-aid construction contracts, design-build contracts, subcontracts, lower-tier subcontracts, purchase orders, lease agreements, consultant contracts or any other covered transaction requiring FHWA approval or that is estimated to cost \$25,000 or more – as defined in 2 CFR Parts 180 and 1200.

**1. Instructions for Certification – First Tier Participants:**

- a. By signing and submitting this proposal, the prospective first tier participant is providing the certification set out below.
- b. The inability of a person to provide the certification set out below will not necessarily result in denial of participation in this covered transaction. The prospective first tier participant shall submit an explanation of why it cannot provide the certification set out below. The certification or explanation will be considered in connection with the department or agency's determination whether to enter into this transaction. However, failure of the prospective first tier participant to furnish a certification or an explanation shall disqualify such a person from participation in this transaction.
- c. The certification in this clause is a material representation of fact upon which reliance was placed when the contracting agency determined to enter into this transaction. If it is later determined that the prospective participant knowingly rendered an erroneous certification, in addition to other remedies available to the Federal Government, the contracting agency may terminate this transaction for cause of default.
- d. The prospective first tier participant shall provide immediate written notice to the contracting agency to whom this proposal is submitted if any time the prospective first tier participant learns that its certification was erroneous when submitted or has become erroneous by reason of changed circumstances.
- e. The terms "covered transaction," "debarred," "suspended," "ineligible," "participant," "person," "principal," and "voluntarily excluded," as used in this clause, are defined in 2 CFR Parts 180 and 1200. "First Tier Covered Transactions" refers to any covered transaction between a grantee or subgrantee of Federal funds and a participant (such as the prime or general contract). "Lower Tier Covered Transactions" refers to any covered transaction under a First Tier Covered Transaction (such as subcontracts). "First Tier Participant" refers to the participant who has entered into a covered transaction with a grantee or subgrantee of Federal funds (such as the prime or general contractor). "Lower Tier Participant" refers any participant who has entered into a covered transaction with a First Tier Participant or other Lower Tier Participants (such as subcontractors and suppliers).
- f. The prospective first tier participant agrees by submitting this proposal that, should the proposed covered transaction be entered into, it shall not knowingly enter into any lower tier covered transaction with a person who is debarred, suspended, declared ineligible, or voluntarily excluded from participation in this covered transaction, unless authorized by the department or agency entering into this transaction.
- g. The prospective first tier participant further agrees by submitting this proposal that it will include the clause titled "Certification Regarding Debarment, Suspension, Ineligibility and Voluntary Exclusion-Lower Tier Covered Transactions," provided by the department or contracting agency, entering into this covered transaction, without modification, in all lower tier covered transactions and in all solicitations for lower tier covered transactions exceeding the \$25,000 threshold.
- h. A participant in a covered transaction may rely upon a certification of a prospective participant in a lower tier covered transaction that is not debarred, suspended, ineligible, or voluntarily excluded from the covered transaction, unless it knows that the certification is erroneous. A participant is responsible for ensuring that its principals are not suspended, debarred, or otherwise ineligible to participate in covered transactions. To verify the eligibility of its principals, as well as the eligibility of any lower tier prospective participants, each participant may, but is not required to, check the Excluded Parties List System website (<https://www.epls.gov/>), which is compiled by the General Services Administration.
- i. Nothing contained in the foregoing shall be construed to require the establishment of a system of records in order to render in good faith the certification required by this clause. The knowledge and information of the prospective participant is not required to exceed that which is normally possessed by a prudent person in the ordinary course of business dealings.
- j. Except for transactions authorized under paragraph (f) of these instructions, if a participant in a covered transaction knowingly enters into a lower tier covered transaction with a person who is suspended, debarred, ineligible, or voluntarily excluded from participation in this transaction, in addition to other remedies available to the Federal Government, the department or agency may terminate this transaction for cause or default.

\* \* \* \* \*

**2. Certification Regarding Debarment, Suspension, Ineligibility and Voluntary Exclusion – First Tier Participants:**

- a. The prospective first tier participant certifies to the best of its knowledge and belief, that it and its principals:
  - (1) Are not presently debarred, suspended, proposed for debarment, declared ineligible, or voluntarily excluded from participating in covered transactions by any Federal department or agency;
  - (2) Have not within a three-year period preceding this proposal been convicted of or had a civil judgment rendered against them for commission of fraud or a criminal offense in connection with obtaining, attempting to obtain, or performing a public (Federal, State or local) transaction or contract under a public transaction; violation of Federal or State antitrust statutes or commission of embezzlement, theft, forgery, bribery, falsification or destruction of records, making false statements, or receiving stolen property;
  - (3) Are not presently indicted for or otherwise criminally or civilly charged by a governmental entity (Federal, State or local) with commission of any of the offenses enumerated in paragraph (a)(2) of this certification; and
  - (4) Have not within a three-year period preceding this application/proposal had one or more public transactions (Federal, State or local) terminated for cause or default.
- b. Where the prospective participant is unable to certify to any of the statements in this certification, such prospective participant shall attach an explanation to this proposal.

**2. Instructions for Certification - Lower Tier Participants:**

(Applicable to all subcontracts, purchase orders and other lower tier transactions requiring prior FHWA approval or estimated to cost \$25,000 or more - 2 CFR Parts 180 and 1200)

- a. By signing and submitting this proposal, the prospective lower tier is providing the certification set out below.
- b. The certification in this clause is a material representation of fact upon which reliance was placed when this transaction was entered into. If it is later determined that the prospective lower tier participant knowingly rendered an erroneous certification, in addition to other remedies available to the Federal Government, the department, or agency with which this transaction originated may pursue available remedies, including suspension and/or debarment.
- c. The prospective lower tier participant shall provide immediate written notice to the person to which this proposal is submitted if at any time the prospective lower tier participant learns that its certification was erroneous by reason of changed circumstances.
- d. The terms "covered transaction," "debarred," "suspended," "ineligible," "participant," "person," "principal," and "voluntarily excluded," as used in this clause, are defined in 2 CFR Parts 180 and 1200. You may contact the person to which this proposal is submitted for assistance in obtaining a copy of those regulations. "First Tier Covered Transactions" refers to any covered transaction between a grantee or subgrantee of

Federal funds and a participant (such as the prime or general contract). "Lower Tier Covered Transactions" refers to any covered transaction under a First Tier Covered Transaction (such as subcontracts). "First Tier Participant" refers to the participant who has entered into a covered transaction with a grantee or subgrantee of Federal funds (such as the prime or general contractor). "Lower Tier Participant" refers any participant who has entered into a covered transaction with a First Tier Participant or other Lower Tier Participants (such as subcontractors and suppliers).

- e. The prospective lower tier participant agrees by submitting this proposal that, should the proposed covered transaction be entered into, it shall not knowingly enter into any lower tier covered transaction with a person who is debarred, suspended, declared ineligible, or voluntarily excluded from participation in this covered transaction, unless authorized by the department or agency with which this transaction originated.
- f. The prospective lower tier participant further agrees by submitting this proposal that it will include this clause titled "Certification Regarding Debarment, Suspension, Ineligibility and Voluntary Exclusion-Lower Tier Covered Transaction," without modification, in all lower tier covered transactions and in all solicitations for lower tier covered transactions exceeding the \$25,000 threshold.
- g. A participant in a covered transaction may rely upon a certification of a prospective participant in a lower tier covered transaction that is not debarred, suspended, ineligible, or voluntarily excluded from the covered transaction, unless it knows that the certification is erroneous. A participant is responsible for ensuring that its principals are not suspended, debarred, or otherwise ineligible to participate in covered transactions. To verify the eligibility of its principals, as well as the eligibility of any lower tier prospective participants, each participant may, but is not required to, check the Excluded Parties List System website (<https://www.epls.gov/>), which is compiled by the General Services Administration.
- h. Nothing contained in the foregoing shall be construed to require establishment of a system of records in order to render in good faith the certification required by this clause. The knowledge and information of participant is not required to exceed that which is normally possessed by a prudent person in the ordinary course of business dealings.
- i. Except for transactions authorized under paragraph e of these instructions, if a participant in a covered transaction knowingly enters into a lower tier covered transaction with a person who is suspended, debarred, ineligible, or voluntarily excluded from participation in this transaction, in addition to other remedies available to the Federal Government, the department or agency with which this transaction originated may pursue available remedies, including suspension and/or debarment.

\* \* \* \* \*

**Certification Regarding Debarment, Suspension, Ineligibility and Voluntary Exclusion--Lower Tier Participants:**

1. The prospective lower tier participant certifies, by submission of this proposal, that neither it nor its principals is presently debarred, suspended, proposed for debarment, declared ineligible, or voluntarily excluded from participating in covered transactions by any Federal department or agency.
2. Where the prospective lower tier participant is unable to certify to any of the statements in this certification, such prospective participant shall attach an explanation to this proposal.

\* \* \* \* \*

**XI. CERTIFICATION REGARDING USE OF CONTRACT FUNDS FOR LOBBYING**

This provision is applicable to all Federal-aid construction contracts and to all related subcontracts which exceed \$100,000 (49 CFR 20).

1. The prospective participant certifies, by signing and submitting this bid or proposal, to the best of his or her knowledge and belief, that:
  - a. No Federal appropriated funds have been paid or will be paid, by or on behalf of the undersigned, to any person for influencing or attempting to influence an officer or employee of any Federal agency, a Member of Congress, an officer or employee of Congress, or an employee of a Member of Congress in connection with the awarding of any Federal contract, the making of any Federal grant, the making of any Federal loan, the entering into of any cooperative agreement, and the extension, continuation, renewal, amendment, or modification of any Federal contract, grant, loan, or cooperative agreement.
  - b. If any funds other than Federal appropriated funds have been paid or will be paid to any person for influencing or attempting to influence an officer or employee of any Federal agency, a Member of Congress, an officer or employee of Congress, or an employee of a Member of Congress in connection with this Federal contract, grant, loan, or cooperative agreement, the undersigned shall complete and submit Standard Form-LLL, "Disclosure Form to Report Lobbying," in accordance with its instructions.
2. This certification is a material representation of fact upon which reliance was placed when this transaction was made or entered into. Submission of this certification is a prerequisite for making or entering into this transaction imposed by 31 U.S.C. 1352. Any person who fails to file the required certification shall be subject to a civil penalty of not less than \$10,000 and not more than \$100,000 for each such failure.
3. The prospective participant also agrees by submitting its bid or proposal that the participant shall require that the language of this certification be included in all lower tier subcontracts, which exceed \$100,000 and that all such recipients shall certify and disclose accordingly.

**STANDARD SPECIAL PROVISION****ON-THE-JOB TRAINING**

(10-16-07) (Rev. 4-21-15)

Z-10

**Description**

The North Carolina Department of Transportation will administer a custom version of the Federal On-the-Job Training (OJT) Program, commonly referred to as the Alternate OJT Program. All contractors (existing and newcomers) will be automatically placed in the Alternate Program. Standard OJT requirements typically associated with individual projects will no longer be applied at the project level. Instead, these requirements will be applicable on an annual basis for each contractor administered by the OJT Program Manager.

On the Job Training shall meet the requirements of 23 CFR 230.107 (b), 23 USC – Section 140, this provision and the On-the-Job Training Program Manual.

The Alternate OJT Program will allow a contractor to train employees on Federal, State and privately funded projects located in North Carolina. However, priority shall be given to training employees on NCDOT Federal-Aid funded projects.

**Minorities and Women**

Developing, training and upgrading of minorities and women toward journeyman level status is a primary objective of this special training provision. Accordingly, the Contractor shall make every effort to enroll minority and women as trainees to the extent that such persons are available within a reasonable area of recruitment. This training commitment is not intended, and shall not be used, to discriminate against any applicant for training, whether a member of a minority group or not.

**Assigning Training Goals**

The Department, through the OJT Program Manager, will assign training goals for a calendar year based on the contractors' past three years' activity and the contractors' anticipated upcoming year's activity with the Department. At the beginning of each year, all contractors eligible will be contacted by the Department to determine the number of trainees that will be assigned for the upcoming calendar year. At that time the Contractor shall enter into an agreement with the Department to provide a self-imposed on-the-job training program for the calendar year. This agreement will include a specific number of annual training goals agreed to by both parties. The number of training assignments may range from 1 to 15 per contractor per calendar year. The Contractor shall sign an agreement to fulfill their annual goal for the year.\

**Training Classifications**

The Contractor shall provide on-the-job training aimed at developing full journeyman level workers in the construction craft/operator positions. Preference shall be given to providing training in the following skilled work classifications:

Equipment Operators	Office Engineers
Truck Drivers	Estimators
Carpenters	Iron / Reinforcing Steel Workers
Concrete Finishers	Mechanics
Pipe Layers	Welders

The Department has established common training classifications and their respective training requirements that may be used by the contractors. However, the classifications established are not all-inclusive. Where the training is oriented toward construction applications, training will be allowed in lower-level management positions such as office engineers and estimators. Contractors shall submit new classifications for specific job functions that their employees are performing. The Department will review and recommend for acceptance to FHWA the new classifications proposed by contractors, if applicable. New classifications shall meet the following requirements:

Proposed training classifications are reasonable and realistic based on the job skill classification needs, and

The number of training hours specified in the training classification is consistent with common practices and provides enough time for the trainee to obtain journeyman level status.

The Contractor may allow trainees to be trained by a subcontractor provided that the Contractor retains primary responsibility for meeting the training and this provision is made applicable to the subcontract. However, only the Contractor will receive credit towards the annual goal for the trainee.

Where feasible, 25 percent of apprentices or trainees in each occupation shall be in their first year of apprenticeship or training. The number of trainees shall be distributed among the work classifications on the basis of the contractor's needs and the availability of journeymen in the various classifications within a reasonable area of recruitment.

No employee shall be employed as a trainee in any classification in which they have successfully completed a training course leading to journeyman level status or in which they have been employed as a journeyman.

**Records and Reports**

The Contractor shall maintain enrollment, monthly and completion reports documenting company compliance under these contract documents. These documents and any other information as requested shall be submitted to the OJT Program Manager.

Upon completion and graduation of the program, the Contractor shall provide each trainee with a certification Certificate showing the type and length of training satisfactorily completed.

**Trainee Interviews**

All trainees enrolled in the program will receive an initial and Trainee/Post graduate interview conducted by the OJT program staff.

**Trainee Wages**

Contractors shall compensate trainees on a graduating pay scale based upon a percentage of the prevailing minimum journeyman wages (Davis-Bacon Act). Minimum pay shall be as follows:

60 percent	of the journeyman wage for the first half of the training period
75 percent	of the journeyman wage for the third quarter of the training period
90 percent	of the journeyman wage for the last quarter of the training period

In no instance shall a trainee be paid less than the local minimum wage. The Contractor shall adhere to the minimum hourly wage rate that will satisfy both the NC Department of Labor (NCDOL) and the Department.

**Achieving or Failing to Meet Training Goals**

The Contractor will be credited for each trainee employed by him on the contract work who is currently enrolled or becomes enrolled in an approved program and who receives training for at least 50 percent of the specific program requirement. Trainees will be allowed to be transferred between projects if required by the Contractor's scheduled workload to meet training goals.

If a contractor fails to attain their training assignments for the calendar year, they may be taken off the NCDOT's Bidders List.

**Measurement and Payment**

No compensation will be made for providing required training in accordance with these contract documents.

**STANDARD SPECIAL PROVISION**  
**MINIMUM WAGES**  
**GENERAL DECISION NC20210088 01/01/2021 NC88**

Z-088

Date: January 1, 2021

General Decision Number: NC20210088 01/01/2021 NC88

Superseded General Decision Numbers: NC20200088

State: North Carolina

Construction Type: HIGHWAY

**COUNTIES:**

Alamance	Forsyth	Randolph
Anson	Gaston	Rockingham
Cabarrus	Guilford	Stokes
Chatham	Mecklenburg	Union
Davie	Orange	Yadkin
Durham	Person	

HIGHWAY CONSTRUCTION PROJECTS (excluding tunnels, building structures in rest area projects & railroad construction; bascule, suspension & spandrel arch bridges designed for commercial navigation, bridges involving marine construction; and other major bridges).

Note: Under Executive Order (EO) 13658, an hourly minimum wage of \$10.95 for calendar year 2021 applies to all contracts subject to the Davis-Bacon Act for which the contract is awarded (and any solicitation was issued) on or after January 1, 2015. If this contract is covered by the EO, the contractor must pay all workers in any classification listed on this wage determination at least \$10.95 per hour (or the applicable wage rate listed on this wage determination, if it is higher) for all hours spent performing on the contract for calendar year 2021. If this contract is covered by the EO and a classification considered necessary for performance of work on the contract does not appear on this wage determination, the contractor must pay workers in that classification at least the wage rate determined through the conformance process set forth in 29 CFR.5.5(a)(1)(ii) (or the EO minimum wage rate, if it is higher than the conformed wage rate). The EO minimum wage rate will be adjusted annually. Please note that this EO applies to the above-mentioned types of contracts entered into by the federal government that are subject to the Davis-Bacon Act itself, but it does not apply to contracts subject only to the Davis-Bacon Related Acts, including those set forth at 29 CFR 5.1(a)(2) – (60). Additional information on contractor requirements and worker protections under the EO is available at [www.dol.gov/whd/govcontracts](http://www.dol.gov/whd/govcontracts).

Modification Number

0

Publication Date

01/01/2021

SUNC2014-003 11/14/2014

	Rates	Fringes
BLASTER	18.64	
CARPENTER	13.68	.05
CEMENT MASON/CONCRETE FINISHER	13.93	
ELECTRICIAN		
Electrician	18.79	2.72

	Rates	Fringes
Telecommunications Technician	15.19	1.25
IRONWORKER	13.30	
LABORER		
Asphalt Raker and Spreader	12.78	
Asphalt Screed/Jackman	14.50	
Carpenter Tender	12.51	.27
Cement Mason/Concrete Finisher Tender	11.04	
Common or General	10.40	.01
Guardrail/Fence Installer	13.22	
Pipelayer	12.43	
Traffic Signal/Lighting Installer	15.65	.24
PAINTER		
Bridge	23.77	
POWER EQUIPMENT OPERATORS		
Asphalt Broom Tractor	10.00	
Bulldozer Fine	16.13	
Bulldozer Rough	14.36	
Concrete Grinder/Groover	17.92	
Crane Boom Trucks	18.19	
Crane Other	19.83	
Crane Rough/All-Terrain	19.10	
Drill Operator Rock	14.28	
Drill Operator Structure	20.89	
Excavator Fine	16.95	
Excavator Rough	13.63	
Grader/Blade Fine	19.84	
Grader/Blade Rough	15.47	
Loader 2 Cubic Yards or Less	13.31	
Loader Greater Than 2 Cubic Yards	16.19	
Material Transfer Vehicle (Shuttle Buggy)	15.44	
Mechanic	17.51	
Milling Machine	15.22	
Off-Road Hauler/Water Tanker	11.83	
Oiler/Greaser	14.16	
Pavement Marking Equipment	12.05	
Paver Asphalt	15.97	
Paver Concrete	18.20	
Roller Asphalt Breakdown	12.79	
Roller Asphalt Finish	13.76	
Roller Other	12.08	
Scraper Finish	12.65	
Scraper Rough	11.50	
Slip Form Machine	19.60	
Tack Truck/Distributor Operator	14.82	
TRUCK DRIVER		
GVWR of 26,000 Lbs or Less	11.45	
GVWR of 26,001 Lbs or Greater	13.57	.03

Welders – Receive rate prescribed for craft performing operation to which welding is incidental.

Note: Executive Order (EO) 13706, Establishing Paid Sick Leave for Federal Contractors applies to all contracts subject to the Davis-Bacon Act for which the contract is awarded (and any



solicitation was issued) on or after January 1, 2017. If this contract is covered by the EO, the contractor must provide employees with 1 hour of paid sick leave for every 30 hours they work, up to 56 hours of paid sick leave each year. Employees must be permitted to use paid sick leave for their own illness, injury or other health-related needs, including preventive care; to assist a family member (or person who is like family to the employee) who is ill, injured, or has other health-related needs, including preventive care; or for reasons resulting from, or to assist a family member (or person who is like family to the employee) who is a victim of, domestic violence, sexual assault, or stalking. Additional information on contractor requirements and worker protections under the EO is available at [www.dol.gov/whd/govcontracts](http://www.dol.gov/whd/govcontracts).

Unlisted classifications needed for work not included within the scope of the classifications listed may be added after award only as provided in the labor standards contract clauses (29 CFR 5.5(a)(1)(ii)).

The body of each wage determination lists the classification and wage rates that have been found to be prevailing for the cited type(s) of construction in the area covered by the wage determination. The classifications are listed in alphabetical order of "identifiers" that indicate whether the particular rate is a union rate (current union negotiated rate for local), a survey rate (weighted average rate) or a union average rate (weighted union average rate).

#### Union Rate Identifiers

A four letter classification abbreviation identifier enclosed in dotted lines beginning with characters other than "SU" or "UAVG" denotes that the union classification and rate were prevailing for that classification in the survey. Example: PLUM0198-005 07/01/2014. PLUM is an abbreviation identifier of the union which prevailed in the survey for this classification, which in this example would be Plumbers. 0198 indicates the local union number or district council number where applicable, i.e., Plumbers Local 0198. The next number, 005 in the example, is an internal number used in processing the wage determination. 07/01/2014 is the effective date of the most current negotiated rate, which in this example is July 1, 2014.

Union prevailing wage rates are updated to reflect all rate changes in the collective bargaining agreement (CBA) governing this classification and rate.

#### Survey Rate Identifiers

Classifications listed under the "SU" identifier indicate that no one rate prevailed for this classification in the survey and the published rate is derived by computing a weighted average rate based on all the rates reported in the survey for that classification. As this weighted average rate includes all rates reported in the survey, it may include both union and non-union rates. Example: SULA2012-007 5/13/2014. SU indicates the rates are survey rates based on a weighted average calculation of rates and are not majority rates. LA indicates the State of Louisiana. 2012 is the year of survey on which these classifications and rates are based. The next number, 007 in the example, is an internal number used in producing the wage determination. 5/13/2014 indicates the survey completion date for the classifications and rates under that identifier.

Survey wage rates are not updated and remain in effect until a new survey is conducted.

#### Union Average Rate Identifiers

Classification(s) listed under the UAVG identifier indicate that no single majority rate prevailed for those classifications; however, 100% of the data reported for the classifications was union data. EXAMPLE: UAVG-OH-0010 08/29/2014. UAVG indicates that the rate is a weighted union average rate. OH indicates the state. The next number, 0010 in the example, is an internal number used in producing the wage determination. 08/29/2014 indicates the survey completion date for the classifications and rates under that identifier.

A UAVG rate will be updated once a year, usually in January of each year, to reflect a weighted average of the current negotiated/CBA rate of the union locals from which the rate is based.

#### WAGE DETERMINATION APPEALS PROCESS

1.) Has there been an initial decision in the matter? This can be:

- \* an existing published wage determination
- \* a survey underlying a wage determination
- \* a Wage and Hour Division letter setting forth a position on a wage determination matter
- \* a conformance (additional classification and rate) ruling

On survey related matters, initial contact, including requests for summaries of surveys, should be with the Wage and Hour Regional Office for the area in which the survey was conducted because those Regional Offices have responsibility for the Davis-Bacon survey program. If the response from this initial contact is not satisfactory, then the process described in 2.) and 3.) should be followed.

With regard to any other matter not yet ripe for the formal process described here, initial contact should be with the Branch of Construction Wage Determinations. Write to:

Branch of Construction Wage Determinations  
Wage and Hour Division  
U. S. Department of Labor  
200 Constitution Avenue, N.W.  
Washington, D.C. 20210

2.) If the answer to the question in 1.) is yes, then an interested party (those affected by the action) can request review and reconsideration from the Wage and Hour Administrator (See 29 CFR Part 1.8 and 29 CFR Part 7). Write to:

Wage and Hour Administrator  
U.S. Department of Labor  
200 Constitution Avenue, N.W.  
Washington, D.C. 20210

The request should be accompanied by a full statement of the interested party's position and by any information (wage payment data, project description, area practice material, etc.) that the requestor considers relevant to the issue.

3.) If the decision of the Administrator is not favorable, an interested party may appeal directly to the Administrative Review Board (formerly the Wage Appeals Board). Write to:

Administrative Review Board  
U.S. Department of Labor  
200 Constitution Avenue, N.W.

Washington, D.C. 20210

4.) All decisions by the Administrative Review Board are final.

END OF GENERAL DECISION

**PROJECT SPECIAL PROVISIONS**

**GEOTECHNICAL**

STANDARD SHORING - (1/16/2018)

GT-1.1 - GT-1.4

MSE RETAINING WALLS - (1-16-2018)

GT-2.1 - GT-2.12

DocuSigned by:

*Geotechnical Engineering Unit*

E06538624A11498...

7/1/2019

**STANDARD SHORING:****(1-16-18)****Description**

Standard shoring includes standard temporary shoring and standard temporary mechanically stabilized earth (MSE) walls. At the Contractor's option, use standard shoring as noted in the plans or as directed. When using standard shoring, a temporary shoring design submittal is not required. Construct standard shoring based on actual elevations and shoring dimensions in accordance with the contract and Geotechnical Standard Detail No. 1801.01 or 1801.02.

Define "standard temporary shoring" as cantilever shoring that meets the standard temporary shoring detail (Geotechnical Standard Detail No. 1801.01). Define "standard temporary wall" as a temporary MSE wall with geotextile or geogrid reinforcement that meets the standard temporary wall detail (Geotechnical Standard Detail No. 1801.02). Define "standard temporary geotextile wall" as a standard temporary wall with geotextile reinforcement and "standard temporary geogrid wall" as a standard temporary wall with geogrid reinforcement.

Provide positive protection for standard shoring at locations shown in the plans and as directed. See *Temporary Shoring* provision for positive protection types and definitions.

**Materials**

Refer to the *Standard Specifications*.

<b>Item</b>	<b>Section</b>
Concrete Barrier Materials	1170-2
Flowable Fill, Excavatable	1000-6
Geosynthetics	1056
Neat Cement Grout, Type 1	1003
Portland Cement Concrete, Class A	1000
Select Materials	1016
Steel Beam Guardrail Materials	862-2
Steel Sheet Piles and H-Piles	1084
Untreated Timber	1082-2
Welded Wire Reinforcement	1070-3

Provide Type 6 material certifications for shoring materials. Use Class IV select material for temporary guardrail. Use Class A concrete that meets Article 450-2 of the *Standard Specifications* or grout for drilled-in piles.

Based on actual shoring height, positive protection, groundwater elevation, slope or surcharge case and traffic impact at each standard temporary shoring location, use sheet piles with the minimum required section modulus or H-piles with the sizes shown in Geotechnical Standard Detail No. 1801.01. Use untreated timber with a thickness of at least 3" and a bending stress of at least 1,000 psi for timber lagging.

**(A) Shoring Backfill**

Use Class II, Type 1, Class III, Class V or Class VI select material or material that meets AASHTO M 145 for soil classification A-2-4 with a maximum PI of 6 for shoring backfill except do not use the following:

- (1) A-2-4 soil for backfill around culverts,

- (2) A-2-4 soil in the reinforced zone of standard temporary walls with a back slope and
- (3) Class VI select material in the reinforced zone of standard temporary geotextile walls.

**(B) Standard Temporary Walls**

Use welded wire reinforcement for welded wire facing, struts and wires with the dimensions and minimum wire sizes shown in Geotechnical Standard Detail No. 1801.02. Provide Type 2 geotextile for separation and retention geotextiles. Do not use more than 4 different reinforcement strengths for each standard temporary wall.

**(1) Geotextile Reinforcement**

Provide Type 5 geotextile for geotextile reinforcement with a mass per unit area of at least 8 oz/sy in accordance with ASTM D5261. Based on actual wall height, groundwater elevation, slope or surcharge case and shoring backfill to be used in the reinforced zone at each standard temporary geotextile wall location, provide geotextiles with ultimate tensile strengths as shown in Geotechnical Standard Detail No. 1801.02.

**(2) Geogrid Reinforcement**

Use geogrids with a roll width of at least 4 ft and an “approved” or “approved for provisional use” status code. The list of approved geogrids is available from: [connect.ncdot.gov/resources/Materials/Pages/Materials-Manual-by-Material.aspx](http://connect.ncdot.gov/resources/Materials/Pages/Materials-Manual-by-Material.aspx)

Based on actual wall height, groundwater elevation, slope or surcharge case and shoring backfill to be used in the reinforced zone at each standard temporary geogrid wall location, provide geogrids for geogrid reinforcement with short-term design strengths as shown in Geotechnical Standard Detail No. 1801.02. Geogrids are typically approved for ultimate tensile strengths in the machine direction (MD) and cross-machine direction (CD) or short-term design strengths for a 3-year design life in the MD based on material type. Define material type from the website above for shoring backfill as follows:

<b>Material Type</b>	<b>Shoring Backfill</b>
Borrow	A-2-4 Soil
Fine Aggregate	Class II, Type 1 or Class III Select Material
Coarse Aggregate	Class V or VI Select Material

If the website does not list a short-term design strength for an approved geogrid, use a short-term design strength equal to the ultimate tensile strength divided by 3.5 for the geogrid reinforcement.

**Preconstruction Requirements**

**(A) Concrete Barrier**

Define “clear distance” behind concrete barrier as the horizontal distance between the barrier and edge of pavement. The minimum required clear distance for concrete barrier is shown in the plans. At the Contractor’s option or if the minimum required clear

distance is not available, set concrete barrier next to and up against traffic side of standard shoring except for barrier above standard temporary walls. Concrete barrier with the minimum required clear distance is required above standard temporary walls.

**(B) Temporary Guardrail**

Define “clear distance” behind temporary guardrail as the horizontal distance between guardrail posts and standard shoring. At the Contractor’s option or if clear distance for standard temporary shoring is less than 4 ft, attach guardrail to traffic side of shoring as shown in the plans. Place ABC in clear distance and around guardrail posts instead of pavement. Do not use temporary guardrail above standard temporary walls.

**(C) Standard Shoring Selection Forms**

Before beginning standard shoring construction, survey existing ground elevations in the vicinity of standard shoring locations to determine actual shoring or wall heights (H). Submit a standard shoring selection form for each location at least 7 days before starting standard shoring construction. Standard shoring selection forms are available from:  
[connect.ncdot.gov/resources/Geological/Pages/Geotech\\_Forms\\_Details.aspx](http://connect.ncdot.gov/resources/Geological/Pages/Geotech_Forms_Details.aspx)

**Construction Methods**

Construct standard shoring in accordance with the *Temporary Shoring* provision.

**(A) Standard Temporary Shoring Installation**

Based on actual shoring height, positive protection, groundwater elevation, slope or surcharge case and traffic impact at each standard temporary shoring location, install piles with the minimum required embedment and extension for each shoring section in accordance with Geotechnical Standard Detail No. 1801.01. For concrete barrier above and next to standard temporary shoring and temporary guardrail above and attached to standard temporary shoring, use “surcharge case with traffic impact” in accordance with Geotechnical Standard Detail No. 1801.01. Otherwise, use “slope or surcharge case with no traffic impact” in accordance with Geotechnical Standard Detail No. 1801.01. If refusal is reached before driven piles attain the minimum required embedment, use drilled-in H-piles with timber lagging for standard temporary shoring.

**(B) Standard Temporary Walls Installation**

Based on actual wall height, groundwater elevation, slope or surcharge case, geotextile or geogrid reinforcement and shoring backfill in the reinforced zone at each standard temporary wall location, construct walls with the minimum required reinforcement length and number of reinforcement layers for each wall section in accordance with Geotechnical Standard Detail No. 1801.02. For standard temporary walls with pile foundations in the reinforced zone, drive piles through reinforcement after constructing temporary walls.

For standard temporary walls with interior angles less than 90°, wrap geosynthetics at acute corners as directed by the Engineer. Place geosynthetics as shown in Geotechnical Standard Detail No. 1801.02. Place separation geotextiles between shoring backfill and backfill, natural ground or culverts along the sides of the reinforced zone perpendicular to the wall face. For Class V or VI select material in the reinforced zone, place separation geotextiles between shoring backfill and backfill or natural ground on top of and at the

back of the reinforced zone.

**Measurement and Payment**

Standard shoring will be measured and paid in accordance with the *Temporary Shoring* provision.

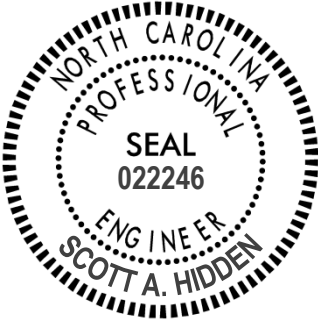

DocuSigned by:  
*Scott A. Hidden*  
F760CAEB96FC4D3...

6/26/2019



**MECHANICALLY STABILIZED EARTH RETAINING WALLS****(1-16-18)****1.0 GENERAL**

Construct mechanically stabilized earth (MSE) retaining walls consisting of steel or geosynthetic reinforcement in the reinforced zone connected to vertical facing elements. Use precast concrete panels for vertical facing elements and coarse aggregate in the reinforced zone unless noted otherwise in the plans. Provide reinforced concrete coping and pile sleeves as required. Design and construct MSE retaining walls based on actual elevations and wall dimensions in accordance with the contract and accepted submittals. Use a prequalified MSE Wall Installer to construct MSE retaining walls.

Define MSE wall terms as follows:

*Geosynthetic or Geogrid Reinforcement* – Polyester Type (PET), HDPE or Polypropylene (PP) geogrid reinforcement,

*Geogrid* – PET, HDPE or PP geogrid,

*Reinforcement* – Steel or geogrid reinforcement,

*Aggregate* – Coarse or fine aggregate,

*Panel* – Precast concrete panel,

*Coping* – Precast or CIP concrete coping,

*MSE Wall* – Mechanically stabilized earth retaining wall,

*MSE Wall Vendor* – Vendor supplying the chosen MSE wall system,

*MSE Panel Wall* – MSE wall with panels,

*MSE Segmental Wall* – MSE wall with segmental retaining wall (SRW) units and

*Abutment Wall* – MSE wall with bridge foundations in any portion of the reinforced zone or an MSE wall connected to an abutment wall (Even if bridge foundations only penetrate a small part of the reinforced zone, the entire MSE wall is considered an abutment wall).

For bridge approach fills behind end bents with MSE abutment walls, design reinforcement connected to end bent caps in accordance with the plans and this provision. Construct Type III Reinforced Bridge Approach Fills in accordance with the *Bridge Approach Fills* provision and Roadway Detail Drawing No. 422D10.

Use an approved MSE wall system in accordance with the plans and any NCDOT restrictions or exceptions for the chosen system. Value engineering proposals for other MSE wall systems will not be considered. Do not use MSE wall systems with an “approved for provisional use” status for abutment walls or MSE walls subject to scour, walls with design heights greater than 35 ft or walls supporting or adjacent to railroads or interstate highways. The list of approved MSE wall systems with approval status is available from:

[connect.ncdot.gov/resources/Geological/Pages/Products.aspx](http://connect.ncdot.gov/resources/Geological/Pages/Products.aspx)

**2.0 MATERIALS**

Refer to the *Standard Specifications*.

**Item**  
Aggregate

**Section**  
1014

Corrugated Steel Pipe	1032-3
Epoxy, Type 3A	1081
Geosynthetics	1056
Grout, Type 3	1003
Joint Materials	1028
Portland Cement Concrete, Class A	1000
Precast Retaining Wall Coping	1077
Reinforcing Steel	1070
Retaining Wall Panels	1077
Segmental Retaining Wall Units	1040-4
Select Material, Class V	1016
Shoulder Drain Materials	816-2
Steel Pipe	1036-4(A)

Use galvanized corrugated steel pipe with a zinc coating weight of 2 oz/sf (G200) for pile sleeves. Provide Type 2 geotextile for filtration and separation geotextiles. Use Class A concrete for CIP coping, leveling concrete and pads. Use galvanized steel pipe, threaded rods and nuts for the PET geogrid reinforcement vertical obstruction detail. Provide galvanized Grade 36 anchor rods and Grade A hex nuts that meet AASHTO M 314 for threaded rods and nuts.

Use panels and SRW units from producers approved by the Department and licensed by the MSE Wall Vendor. Provide steel strip connectors embedded in panels fabricated from structural steel that meets the requirements for steel strip reinforcement. Unless required otherwise in the contract, produce panels with a smooth flat final finish that meets Article 1077-11 of the *Standard Specifications*. Accurately locate and secure reinforcement connectors in panels and maintain required concrete cover. Produce panels within 1/4" of the panel dimensions shown in the accepted submittals.

Damaged panels or SRW units with excessive discoloration, chips or cracks as determined by the Engineer will be rejected. Do not damage reinforcement connection devices or mechanisms in handling or storing panels and SRW units.

Store steel materials on blocking at least 12" above the ground and protect it at all times from damage; and when placing in the work make sure it is free from dirt, dust, loose mill scale, loose rust, paint, oil or other foreign materials. Handle and store geotextiles and geogrids in accordance with Article 1056-2 of the *Standard Specifications*. Load, transport, unload and store MSE wall materials so materials are kept clean and free of damage. Bent, damaged or defective materials will be rejected.

#### A. Aggregate

Use standard size No. 57, 57M, 67 or 78M that meets Table 1005-1 of the *Standard Specifications* for coarse aggregate and the following for fine aggregate:

1. Standard size No. 1S, 2S, 2MS or 4S that meets Table 1005-2 of the *Standard Specifications* or

2. Gradation that meets Class III, Type 3 select material in accordance with Article 1016-3 of the *Standard Specifications*.

Fine aggregate is exempt from mortar strength in Subarticle 1014-1(E) of the *Standard Specifications*. Use fine aggregate with a maximum organic content of 1.0%. Provide aggregate with electrochemical properties that meet the following requirements:

AGGREGATE pH REQUIREMENTS		
Aggregate Type (in reinforced zone)	Reinforcement or Connector Material	pH
Coarse or Fine	Steel	5 – 10
Coarse or Fine	PET	5 – 8
Coarse or Fine	Polyolefin (HDPE or Polypropylene)	4.5 – 9

AGGREGATE CHEMICAL REQUIREMENTS (Steel Reinforcement/Connector Materials Only)			
Aggregate Type (in reinforced zone)	Resistivity	Chlorides	Sulfates
Coarse	$\geq 5,000 \Omega \cdot \text{cm}$	$\leq 100 \text{ ppm}$	$\leq 200 \text{ ppm}$
Fine	$\geq 3,000 \Omega \cdot \text{cm}$		

Use aggregate from sources participating in the Department's Aggregate QC/QA Program as described in Section 1006 of the *Standard Specifications*. Sample and test aggregate in accordance with the *Mechanically Stabilized Earth Wall Aggregate Sampling and Testing Procedures*. Electrochemical testing is only required for coarse aggregate from sources in the Coastal Plain as defined by Subarticle 1018-2(B)(1).

#### B. Reinforcement

Provide steel or geosynthetic reinforcement supplied by the MSE Wall Vendor or a manufacturer approved or licensed by the vendor. Use reinforcement approved for the chosen MSE wall system. The list of approved reinforcement for each MSE wall system is available from the website shown elsewhere in this provision.

##### 1. Steel Reinforcement

Provide Type 1 material certifications in accordance with Article 106-3 of the *Standard Specifications* for steel reinforcement. Use welded wire grid reinforcement ("mesh", "mats" and "ladders") that meet Article 1070-3 of the *Standard Specifications* and steel strip reinforcement ("straps") that meet ASTM A572, A1011 or A463. Use 10 gauge or heavier structural steel Grade 50 or higher for steel strip reinforcement. Galvanize steel reinforcement in accordance with Section 1076 of the *Standard Specifications* or provide aluminized steel strip reinforcement that meet ASTM A463, Type 2-100.

2. Geosynthetic Reinforcement

Use HDPE or PP geogrid for geogrid reinforcement connected to backwalls of end bent caps. Use PET or HDPE geogrid for geogrid reinforcement connected to SRW units and only HDPE geogrid for geogrid reinforcement connected to panels.

Define machine direction (MD) and cross-machine direction (CD) for geogrids per Article 1056-3 of the *Standard Specifications*. Provide Type 1 material certifications and identify geogrid reinforcement in accordance with Article 1056-3 of the *Standard Specifications*.

Provide extruded geogrids manufactured from punched and drawn polypropylene sheets for PP geogrids that meet the following:

<b>PP GEOGRID REQUIREMENTS</b>		
<b>Property</b>	<b>Requirement<sup>1</sup></b>	<b>Test Method</b>
Aperture Dimensions <sup>2</sup>	1" x 1.2"	N/A
Minimum Rib Thickness <sup>2</sup>	0.07" x 0.07"	N/A
Tensile Strength @ 2% Strain <sup>2</sup>	580 lb/ft x 690 lb/ft	ASTM D6637, Method A
Tensile Strength @ 5% Strain <sup>2</sup>	1,200 lb/ft x 1,370 lb/ft	
Ultimate Tensile Strength <sup>2</sup>	1,850 lb/ft x 2,050 lb/ft	
Junction Efficiency <sup>3</sup> (MD)	93%	ASTM D7737
Flexural Rigidity <sup>4</sup>	2,000,000 mg-cm	ASTM D7748
Aperture Stability Modulus <sup>5</sup>	0.55 lb-ft/degrees	ASTM D7864
UV Stability (Retained Strength)	100% (after 500 hr of exposure)	ASTM D4355

1. MARV per Article 1056-3 of the *Standard Specifications* except dimensions and thickness are nominal.
2. Requirement for MD x CD.
3. Junction Efficiency (%) = (Average Junction Strength ( $X_{j_{ave}}$ ) / Ultimate Tensile Strength in the MD from ASTM D6637, Method A) × 100.
4. Test specimens two ribs wide, with transverse ribs cut flush with exterior edges of longitudinal ribs, and sufficiently long to enable measurement of the overhang dimension.
5. Applied moment of 17.7 lb-inch (torque increment).

C. Bearing Pads

For MSE panel walls, use bearing pads that meet Section 3.6.1.a of the *FHWA Design and Construction of Mechanically Stabilized Earth Walls and Reinforced Soil Slopes – Volume I* (Publication No. FHWA-NHI-10-024) except durometer hardness for rubber pads may be 60 or 80 ± 5 and density testing for HDPE pads may be in accordance with ASTM D1505 or D792. Provide bearing pads with thicknesses that meet the following:

<b>BEARING PAD THICKNESS</b>	
<b>Facing Area per Panel (A)</b>	<b>Minimum Pad Thickness After Compression (based on 2 times panel weight above pads)</b>

$A \leq 30$ sf	1/2"
$30 \text{ sf} < A \leq 75$ sf	3/4"

#### D. Miscellaneous Components

Miscellaneous components may include connectors (e.g., anchors, bars, clamps, pins, plates, ties, etc.), fasteners (e.g., bolts, nuts, washers, etc.) and any other MSE wall components not included above. Galvanize steel components in accordance with Section 1076 of the *Standard Specifications*. Provide miscellaneous components approved for the chosen MSE wall system. The list of approved miscellaneous components for each MSE wall system is available from the website shown elsewhere in this provision.

### 3.0 PRECONSTRUCTION REQUIREMENTS

#### A. MSE Wall Surveys

The Retaining Wall Plans show a plan view, typical sections, details, notes and an elevation or profile view (wall envelope) for each MSE wall. Before beginning MSE wall design, survey existing ground elevations shown in the plans and other elevations in the vicinity of MSE wall locations as needed. For proposed slopes above or below MSE walls, survey existing ground elevations to at least 10 ft beyond slope stake points. Based on these elevations, finished grades and actual MSE wall dimensions and details, submit revised wall envelopes for acceptance. Use accepted wall envelopes for design.

#### B. MSE Wall Designs

For MSE wall designs, submit PDF files of working drawings and design calculations at least 30 days before the preconstruction meeting. Note name and NCDOT ID number of the panel or SRW unit production facility on working drawings. Do not begin MSE wall construction until a design submittal is accepted.

Use a prequalified MSE Segmental Wall Design Consultant to design MSE segmental walls. Provide MSE segmental wall designs sealed by a Design Engineer approved as a Geotechnical Engineer (key person) for the MSE Segmental Wall Design Consultant. Provide MSE panel wall designs sealed by a Design Engineer licensed in the state of North Carolina and employed or contracted by the MSE Wall Vendor.

Design MSE walls in accordance with the plans, *AASHTO LRFD Bridge Design Specifications* and any NCDOT restrictions for the chosen MSE wall system unless otherwise required. Design MSE walls for seismic if walls are located in seismic zone 2 based on Figure 2-1 of the *Structure Design Manual*. Connect reinforcement to panels or SRW units with methods or devices approved for the chosen system. Use a uniform reinforcement length throughout the wall height of at least 0.7H with H as shown in the plans or 6 ft, whichever is longer, unless noted otherwise in the plans. Extend the reinforced zone at least 6" beyond end of reinforcement. Do not locate

drains, the reinforced zone or leveling pads outside right-of-way or easement limits.

Use the simplified method for determining maximum reinforcement loads and design parameters approved for the chosen MSE wall system or default values in accordance with the AASHTO LRFD specifications. Design steel components including reinforcement and connectors for the design life noted in the plans and aggregate type in the reinforced zone. If an MSE wall system with geogrid reinforcement includes any steel parts for obstructions, bin walls, connections or other components, design steel exposed to aggregate for the design life noted in the plans and aggregate type in the reinforced zone. Use “loss of galvanizing” metal loss rates for nonaggressive backfill in accordance with the AASHTO LRFD specifications for galvanized and aluminized steel and metal loss rates for carbon steel in accordance with the following:

<b>CARBON STEEL CORROSION RATES</b>	
<b>Aggregate Type (in reinforced zone)</b>	<b>Carbon Steel Loss Rate (after coating depletion)</b>
Coarse	0.47 mil/year
Fine (except abutment walls)	0.58 mil/year
Fine (abutment walls)	0.70 mil/year

For PET or HDPE geogrid reinforcement and geosynthetic connectors, use approved geosynthetic properties for the design life noted in the plans and aggregate type in the reinforced zone. For geogrid reinforcement connected to end bent caps, embed geosynthetic reinforcement or connectors in caps as shown in the plans. For PP geogrid reinforcement connected to end bent caps, use the following design parameters for the aggregate type in the reinforced approach fill.

<b>PP GEOGRID REINFORCEMENT DESIGN PARAMETERS</b>				
<b>Aggregate Type (in reinforced zone)</b>	<b>T<sub>al</sub> (MD)</b>	<b>F*</b>	<b>α</b>	<b>ρ</b>
Coarse	400 lb/ft	0.70	0.8	32.0°
Fine	428 lb/ft	0.54	0.8	28.35°

Where,

- T<sub>al</sub> = long-term design strength (LTDS),  
 F\* = pullout resistance factor,  
 α = scale effect correction factor and  
 ρ = soil-geogrid friction angle.

When noted in the plans, design MSE walls for a live load (traffic) surcharge of 250 psf in accordance with Figure C11.5.6-3(b) of the AASHTO LRFD specifications. For steel beam guardrail with 8 ft posts or concrete barrier rail above MSE walls, analyze top 2 reinforcement layers for traffic impact loads in accordance with Section 7.2 of the FHWA MSE wall manual shown elsewhere in this provision except use the following for geosynthetic reinforcement rupture:

$$\phi T_{al} R_c \geq T_{max} + (T_I / RF_{CR})$$

Where,

- $\phi$  = resistance factor for tensile resistance in accordance with Section 7.2.1 of the FHWA MSE wall manual,
- $T_{al}$  = long-term geosynthetic design strength approved for chosen MSE wall system,
- $R_c$  = reinforcement coverage ratio = 1 for continuous geosynthetic reinforcement,
- $T_{max}$  = factored static load in accordance with Section 7.2 of the FHWA MSE wall manual,
- $T_i$  = factored impact load in accordance with Section 7.2 of the FHWA MSE wall manual and
- $RF_{CR}$  = creep reduction factor approved for chosen MSE wall system.

When shown in the plans for abutment walls, use pile sleeves to segregate piles from aggregate in the reinforced zone. If existing or future obstructions such as foundations, guardrail, fence or handrail posts, moment slabs, pavements, pipes, inlets or utilities will interfere with reinforcement, maintain a clearance of at least 3" between obstructions and reinforcement unless otherwise approved. Design reinforcement for obstructions and locate reinforcement layers so all of reinforcement length is within 3" of corresponding connection elevations. Modify PET geogrid reinforcement for obstructions as shown in the plans.

Use 6" thick CIP unreinforced concrete leveling pads beneath panels and SRW units that are continuous at steps and extend at least 6" in front of and behind bottom row of panels or SRW units. Unless required otherwise in the plans, embed top of leveling pads in accordance with the following requirements:

<b>EMBEDMENT REQUIREMENTS</b>		
<b>Front Slope<sup>1</sup> (H:V)</b>	<b>Minimum Embedment Depth<sup>2</sup> (whichever is greater)</b>	
6:1 or flatter (except abutment walls)	H/20	1 ft for $H \leq 10$ ft 2 ft for $H > 10$ ft
6:1 or flatter (abutment walls)	H/10	2 ft
> 6:1 to < 3:1	H/10	2 ft
3:1 to 2:1	H/7	2 ft

1. Front slope is as shown in the plans.
2. Define "H" as the maximum design height plus embedment per wall with the design height and embedment as shown in the plans.

When noted in the plans, locate a continuous aggregate shoulder drain along the base of the reinforced zone behind the aggregate. Provide wall drainage systems consisting of drains and outlet components in accordance with Roadway Standard Drawing No. 816.02.

For MSE panel walls, cover joints at back of panels with filtration geotextiles at least 12" wide. If the approval of the chosen MSE wall system does not require a minimum

number of bearing pads, provide the number of pads in accordance with the following:

<b>NUMBER OF BEARING PADS</b>		
<b>Facing Area per Panel (A)</b>	<b>Maximum Wall Height Above Horizontal Panel Joint</b>	<b>Minimum Number of Pads per Horizontal Panel Joint</b>
A ≤ 30 sf	25 ft	2
	35 ft <sup>1</sup>	3
30 sf < A ≤ 75 sf	25 ft	3
	35 ft <sup>1</sup>	4

1. Additional bearing pads per horizontal panel joint may be required for wall heights above joints greater than 35 ft.

For MSE segmental walls, coarse aggregate is required in any SRW unit core spaces and between and behind SRW units for a horizontal distance of at least 18". Separation geotextiles are required between the aggregate and overlying fill or pavement sections except when concrete pavement, full depth asphalt or cement treated base is placed directly on aggregate. When noted in the plans, separation geotextiles are also required at the back of the reinforced zone between the aggregate and backfill or natural ground. Unless required otherwise in the plans, use reinforced concrete coping at top of walls that meets the following requirements:

1. Coping dimensions as shown in the plans,
2. At the Contractor's option, coping that is precast or CIP concrete for MSE panel walls unless CIP coping is required as shown in the plans,
3. CIP concrete coping for MSE segmental walls and
4. At the Contractor's option and when shown in the plans, CIP concrete coping that extends down back of panels or SRW units or connects to panels or SRW units with dowels.

For MSE segmental walls with dowels, attach dowels to top courses of SRW units in accordance with the following:

1. Set dowels in core spaces of SRW units filled with grout instead of coarse aggregate or
2. Embed adhesively anchored dowels in holes of solid SRW units with epoxy.

For MSE panel walls with coping, connect CIP concrete coping or leveling concrete for precast concrete coping to top row of panels with dowels cast into panels. When concrete barrier rail is required above MSE walls, use concrete barrier rail with moment slab as shown in the plans.

Submit working drawings and design calculations for acceptance in accordance with Article 105-2 of the *Standard Specifications*. Submit working drawings showing plan views, wall profiles with foundation pressures, typical sections with reinforcement and



connection details, aggregate locations and types, geotextile locations and details of leveling pads, panels or SRW units, coping, bin walls, slip joints, pile sleeves, etc. If necessary, include details on working drawings for concrete barrier rail with moment slab, reinforcement splices if allowed for the chosen MSE wall system, reinforcement connected to end bent caps, curved MSE walls with tight (short) radii and obstructions extending through walls or interfering with reinforcement, leveling pads, barriers or moment slabs. Submit design calculations for each wall section with different surcharge loads, geometry or material parameters. At least one analysis is required for each wall section with different reinforcement lengths. When designing MSE walls with computer software other than MSEW, use MSEW, version 3.0 with update 14.96 or later, manufactured by ADAMA Engineering, Inc. to verify the design. At least one MSEW analysis is required per 100 ft of wall length with at least one analysis for the wall section with the longest reinforcement. Submit electronic MSEW input files and PDF output files with design calculations.

#### C. Preconstruction Meeting

Before starting MSE wall construction, hold a preconstruction meeting to discuss the construction and inspection of the MSE walls. If this meeting occurs before all MSE wall submittals have been accepted, additional preconstruction meetings may be required before beginning construction of MSE walls without accepted submittals. The Resident or Bridge Maintenance Engineer, Area Construction Engineer, Geotechnical Operations Engineer, Contractor and MSE Wall Installer Superintendent will attend preconstruction meetings.

#### 4.0 CORROSION MONITORING

Corrosion monitoring is required for MSE walls with steel reinforcement. The Engineer will determine the number of monitoring locations and where to install the instrumentation. Contact M&T before beginning wall construction. M&T will provide the corrosion monitoring instrumentation kits and if necessary, assistance with installation.

#### 5.0 SITE ASSISTANCE

Unless otherwise approved, an MSE Wall Vendor representative is required to assist and guide the MSE Wall Installer on-site for at least 8 hours when the first panels or SRW units and reinforcement layer are placed. If problems are encountered during construction, the Engineer may require the vendor representative to return to the site for a time period determined by the Engineer.

#### 6.0 CONSTRUCTION METHODS

Control drainage during construction in the vicinity of MSE walls. Direct run off away from MSE walls, aggregate and backfill. Contain and maintain aggregate and backfill and protect material from erosion.

Excavate as necessary for MSE walls in accordance with the accepted submittals. If applicable and at the Contractor's option, use temporary shoring for wall construction

instead of temporary slopes to construct MSE walls. Define “temporary shoring for wall construction” as temporary shoring not shown in the plans or required by the Engineer including shoring for OSHA reasons or the Contractor’s convenience.

Unless required otherwise in the plans, install foundations and if required, pile sleeves located in the reinforced zone before placing aggregate or reinforcement. Brace piles in the reinforced zone to maintain alignment when placing and compacting aggregate. Secure piles together with steel members near top of piles. Clamp members to piles instead of welding if bracing is at or below pile cut-off elevations.

Notify the Engineer when foundation excavation is complete. Do not place leveling pad concrete, aggregate or reinforcement until excavation dimensions and foundation material are approved.

Construct CIP concrete leveling pads at elevations and with dimensions shown in the accepted submittals and in accordance with Section 420 of the *Standard Specifications*. Cure leveling pads at least 24 hours before placing panels or SRW units.

Erect and support panels and stack SRW units so the final wall position is as shown in the accepted submittals. Stagger SRW units to create a running bond by centering SRW units over joints in the row below as shown in the accepted submittals. Space bearing pads in horizontal panel joints as shown in the accepted submittals and cover all panel joints with filtration geotextiles as shown in the accepted submittals. Attach filtration geotextiles to back of panels with adhesives, tapes or other approved methods.

Construct MSE walls with the following tolerances:

- A. SRW units are level from front to back and between units when checked with a 4 ft long level,
- B. Vertical joint widths are 1/4" maximum for SRW units and 3/4",  $\pm 1/4$ " for panels,
- C. Final wall face is within 3/4" of horizontal and vertical alignment shown in the accepted submittals when measured along a 10 ft straightedge and
- D. Final wall plumbness (batter) is not negative (wall face leaning forward) and within 0.5° of vertical unless otherwise approved.

Place reinforcement at locations and elevations shown in the accepted submittals and within 3" of corresponding connection elevations. Install reinforcement with the direction shown in the accepted submittals. Before placing aggregate, pull geogrid reinforcement taut so it is in tension and free of kinks, folds, wrinkles or creases. Reinforcement may be spliced once per reinforcement length if shown in the accepted submittals. Use reinforcement pieces at least 6 ft long. Contact the Engineer when unanticipated existing or future obstructions such as foundations, guardrail, fence or handrail posts, pavements, pipes, inlets or utilities will interfere with reinforcement. To avoid obstructions, deflect, skew or modify reinforcement as shown in the accepted submittals.

Place aggregate in the reinforced zone in 8" to 10" thick lifts. Compact fine aggregate in accordance with Subarticle 235-3(C) of the *Standard Specifications*. Use only hand

operated compaction equipment to compact aggregate within 3 ft of panels or SRW units. At a distance greater than 3 ft, compact aggregate with at least 4 passes of an 8 ton to 10 ton vibratory roller in a direction parallel to the wall face. Smooth wheeled or rubber tired rollers are also acceptable for compacting aggregate. Do not use sheepsfoot, grid rollers or other types of compaction equipment with feet. Do not displace or damage reinforcement when placing and compacting aggregate. End dumping directly on geogrids is not permitted. Do not operate heavy equipment on reinforcement until it is covered with at least 8" of aggregate. Replace any damaged reinforcement to the satisfaction of the Engineer.

Backfill for MSE walls outside the reinforced zone in accordance with Article 410-8 of the *Standard Specifications*. If a drain is required, install wall drainage systems as shown in the accepted submittals and in accordance with Section 816 of the *Standard Specifications*. If pile sleeves are required, fill sleeves with loose uncompacted sand before constructing end bent caps.

Install dowels as necessary for SRW units and place and construct coping and leveling concrete as shown in the accepted submittals. Construct leveling concrete in accordance with Section 420 of the *Standard Specifications*. Construct CIP concrete coping in accordance with Subarticle 452-4(B) of the *Standard Specifications*. When single faced precast concrete barrier is required in front of and against MSE walls, stop coping just above barrier so coping does not interfere with placing barrier up against wall faces. If the gap between a single faced barrier and wall face is wider than 2", fill gap with Class V select material (standard size No. 78M stone). Otherwise, fill gap with backer rod and seal joint between barrier and MSE wall with silicone sealant.

When separation geotextiles are required, overlap adjacent geotextiles at least 18" and hold geotextiles in place with wire staples or anchor pins as needed. Seal joints above and behind MSE walls between coping and concrete slope protection with silicone sealant.

## **7.0 MEASUREMENT AND PAYMENT**

*MSE Retaining Wall No. \_\_\_* will be measured and paid in square feet. MSE walls will be measured as the square feet of wall face area with the pay height equal to the difference between top of wall and top of leveling pad elevations. Define "top of wall" as top of coping or top of panels or SRW units for MSE walls without coping.

The contract unit price for *MSE Retaining Wall No. \_\_\_* will be full compensation for providing designs, submittals, labor, tools, equipment and MSE wall materials, excavating, backfilling, hauling and removing excavated materials and supplying site assistance, leveling pads, panels, SRW units, reinforcement, aggregate, wall drainage systems, geotextiles, bearing pads, coping, miscellaneous components and any incidentals necessary to construct MSE walls. The contract unit price for *MSE Retaining Wall No. \_\_\_* will also be full compensation for reinforcement and connector design for reinforcement connected to end bent caps, wall modifications for obstructions, pile sleeves filled with sand, joints sealed with silicone sealant and gaps between barriers and MSE walls filled with backer rod or No. 78M stone, if required.

No separate payment will be made for temporary shoring for wall construction. Temporary shoring for wall construction will be incidental to the contract unit price for *MSE Retaining Wall No. \_\_*.

The contract unit price for *MSE Retaining Wall No. \_\_* does not include the cost for ditches, fences, handrails, barrier or guardrail associated with MSE walls as these items will be paid for elsewhere in the contract. The contract unit price for *MSE Retaining Wall No. \_\_* also does not include the cost for constructing bridge approach fills behind end bents with MSE abutment walls. See *Bridge Approach Fills* provision for measurement and payment of Type III Reinforced Bridge Approach Fills.

Where it is necessary to provide backfill material behind the reinforced zone from sources other than excavated areas or borrow sources used in connection with other work in the contract, payment for furnishing and hauling such backfill material will be paid as extra work in accordance with Article 104-7 of the *Standard Specifications*. Placing and compacting such backfill material is not considered extra work but is incidental to the work being performed.

Payment will be made under:

**Pay Item**  
MSE Retaining Wall No. \_\_

**Pay Unit**  
Square Foot



DocuSigned by:  
*Scott A. Hidden*  
F760CAEB96FC4D3...  
6/26/2019

**PROJECT SPECIAL PROVISIONS  
GEOENVIRONMENTAL**

**CONTAMINATED SOIL (1/19/2021)**

The Contractor’s attention is directed to the fact that soil contaminated with petroleum hydrocarbon compounds exist within the project area. The known areas of contamination are indicated on corresponding plans sheets. Information relating to these contaminated areas, sample locations, and investigation reports will be available at the following web address by navigating to the correct letting year and month then selecting, “Plans and Proposals”, “I-5711”, “Individual Sheets/520 GeoEnvironmental”:

<http://dotw-xfer01.dot.state.nc.us/dsplan/>

Petroleum contaminated soil may be encountered during any earthwork activities on the project. The Contractor shall only excavate those soils that the Engineer designates necessary to complete a particular task. The Engineer shall determine if soil is contaminated based on areas shown on the plans, petroleum odors, and unusual soil staining. Contaminated soil not required to be excavated is to remain in place and undisturbed. Undisturbed soil shall remain in place, whether contaminated or not. The Contractor shall transport all contaminated soil excavated from the project to a facility licensed to accept contaminated soil.

In the event that a stockpile is needed, the stockpile shall be created within the property boundaries of the source material and in accordance with the Diagram for Temporary Containment and Treatment of Petroleum-Contaminated Soil per North Carolina Department of Environmental Quality’s (NCDEQ) Division of Waste Management UST Section GUIDELINES FOR EX SITU PETROLEUM CONTAMINATED SOIL REMEDIATION. If the volume of contaminated material exceeds available space on site, the Contractor shall obtain a permit from the NCDEQ UST Section’s Regional Office for off-site temporary storage. The Contractor shall provide copies of disposal manifests completed per the disposal facilities requirements and weigh tickets to the Engineer.

**Measurement and Payment:**

The quantity of contaminated soil hauled and disposed of shall be the actual number of tons of material, which has been acceptably transported and weighed with certified scales as documented by disposal manifests and weigh tickets. The quantity of contaminated soil, measured as provided above, shall be paid for at the contract unit price per ton for “Hauling and Disposal of Petroleum Contaminated Soil”.

The above price and payment shall be full compensation for all work covered by this section, including, but not limited to stockpiling, loading, transportation, weighing, laboratory testing, disposal, equipment, decontamination of equipment, labor, and personal protective equipment.

Payment shall be made under:

**Pay Item**

Hauling and Disposal of Petroleum Contaminated Soil

**Pay Unit**

Ton

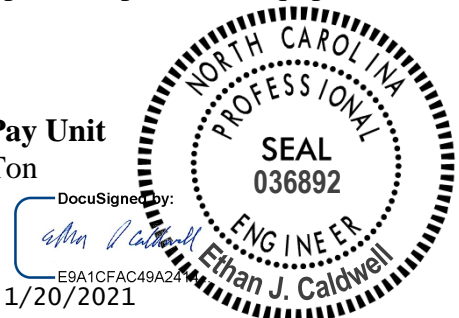

# TC-1

I-5711

Alamance County

## WORK ZONE TRAFFIC CONTROL Project Special Provisions Table of Contents

<b>Special Provision</b>	<b>Page</b>
ADA Compliant Pedestrian Traffic Control Devices	TC-2
Sequential Flashing Warning Lights	TC-3
Pedestrian Transport Service	TC-5



01/19/21

## TC-2

I-5711

Alamance County

### **ADA COMPLIANT PEDESTRIAN TRAFFIC CONTROL DEVICES:**

(10/31/2017)

#### **Description**

Furnish, install, and maintain all ADA compliant pedestrian traffic control devices for existing pedestrian facilities that are disrupted, closed, or relocated by planned work activities.

The ADA compliant pedestrian traffic control devices used to either close, redirect, divert or detour pedestrian traffic are Pedestrian Channelizing Devices and Audible Warning Devices.

#### **Construction Methods**

The ADA compliant pedestrian traffic control devices involved in the closing or redirecting of pedestrians as designated on the Transportation Management Plan (TMP) shall be manufactured and assembled in accordance with the requirements of the Americans with Disabilities Act (ADA) and be on the NCDOT approved products list.

Pedestrian Channelizing Devices shall be manufactured and assembled to be connected as to eliminate any gaps that allow pedestrians to stray from the channelizing path. Any Pedestrian Channelizing Devices used to close or block a pedestrian facility shall have a "SIDEWALK CLOSED" sign affixed to it and any audible warning devices, if designated on the TMP.

Audible Warning Devices shall be manufactured to include a locator tone activated by a motion sensor and have the ability to program a message for a duration of at least 1 minute. The motion sensor shall have the ability to detect pedestrians a minimum of 10' away. The voice module may be automatic or it may be push button activated. If push button activated, it shall be mounted at a height of approximately 3.5 feet, but no more than 4 feet, above the pedestrian facility.

#### **Measurement and Payment**

*Pedestrian Channelizing Devices* will be measured and paid as the maximum number of linear feet of *Pedestrian Channelizing Devices* furnished, acceptably placed, and in use at any one time during the life of the project.

No direct payment will be made for any sign affixed to a pedestrian channelizing device. Signs mounted to pedestrian channelizing devices will be considered incidental to the device.

*Audible Warning Devices* will be measured and paid as the maximum number of *Audible Warning Devices* furnished, acceptably installed, and in use at any one time during the life of the project.

**TC-3**

I-5711

Alamance County

Relocation, replacement, repair, maintenance, or disposal of *Pedestrian Channelizing Devices* and *Audible Warning Devices* will be incidental to the pay item.

Payment will be made under:

<b>Pay Item</b>	<b>Pay Unit</b>
Pedestrian Channelizing Devices	Linear Foot
Audible Warning Devices	Each

**SEQUENTIAL FLASHING WARNING LIGHTS:**

(10/08/2016)

**Description**

Furnish and install Sequential Flashing Warning Lights on drums used for merging tapers during nightly work activities.

The purpose of these lights is to assist the motorist in determining which direction to merge when approaching a lane closure. It's also designed to reduce the number of late merges resulting in devices being struck and having to be reset to maintain positive guidance at the merge point. The successive flashing of the lights shall occur from the upstream end of the merging taper to the downstream end of the merging taper in order to identify the desired vehicle path.

**Materials**

The Sequential Flashing Warning Lights shall meet all of the requirements for warning lights within the current edition of the Manual of Uniform Traffic Control Devices (MUTCD).

Each light unit shall be capable of operating fully and continuously for a minimum of 200 hours when equipped with a standard battery set.

Each light in the sequence shall be flashed at a rate of not less than 55 times per minute and not more than 75 times per minute. The flash rate and flash duration shall be consistent throughout the sequence.

Supply a Type 3 Certification (Independent Test Lab results) documenting all actual test results for the specified parameters contained in the Institute of Transportation Engineer's (ITE's) *Purchase Specification for Flashing and Steady Burn Warning Lights*. The laboratory shall also identify all manufacturer codes and part numbers for the incandescent lamp or LED clusters, lenses, battery, and circuitry, and the total width of the light with the battery in place. The complete assembly shall be certified as crashworthy when firmly affixed to the channelizing device.



# TC-4

I-5711

Alamance County

All Sequential Flashing Warning Lights shall be on the NCDOT Work Zone Traffic Control Approved Products List.

## Construction Methods

Sequential Flashing Warning Lights are to be used for night time lane closures.

These lights shall flash sequentially beginning with the first light and continuing until the final light.

The Sequential Flashing Warning Lights shall automatically flash in sequence when placed on the drums that form the merging taper.

The number of lights used in the drum taper shall equal the number of drums used in the taper.

Drums are the only channelizing device allowed to mount sequential flashing warning lights.

The Sequential Flashing Warning Lights shall be weather independent and visual obstructions shall not interfere with the operation of the lights.

The Sequential Flashing Warning Lights shall automatically sequence when placed in line in an open area with a distance between lights of 10 to 100 feet. A 10 foot stagger in the line of lights shall have no adverse effect on the operation of the lights.

If one light fails, the flashing sequence shall continue. If more than 1 light fails, all of the lights are to be automatically turned to the "off" mode. Non-sequential flashing is prohibited.

When lane closures are not in effect, the Sequential Flashing Warning Lights shall be deactivated.

## Measurement and Payment

Sequential Flashing Warning Lights will be measured and paid as the maximum number of sequential flashing warning lights satisfactorily installed and properly functioning at any one time during the life of the project.

This includes all materials and labor to install, maintain and remove all the Sequential Flashing Warning Lights.

### Pay Item

Sequential Flashing Warning Lights

### Pay Unit

Each

## TC-5

I-5711

Alamance County

### **PEDESTRIAN TRANSPORT SERVICE:**

(09/07/2018)

#### **Description**

The Contractor shall provide a Pedestrian Transport Service through and/or around the project when a traversable, firm, stable, and slip-resistant path for pedestrians cannot be maintained through the work area. At minimum, the Pedestrian Transport Service shall be on-call between the hours of 7:00 a.m. and 8:00 p.m. Monday thru Sunday, and operate at no-cost to the users.

#### **Construction Methods**

The Contractor shall enlist the services of a registered, licensed, and insured transportation service (which may include ride-sharing or taxi services) during the times listed above.

The Pedestrian Transport Service shall operate on an on-call basis with wait times not exceeding 15 minutes. Pedestrians shall be able to request a ride by calling or text messaging a conspicuously posted number using standard cellular phone. The posted number shall either automatically dispatch a transport vehicle to the pedestrian's location, or shall connect to a responsible individual who can manually dispatch a transport vehicle to the pedestrian's location.

Solely requiring pedestrians to use a third-party cellular phone application (smart phone app) to dispatch the transport vehicle shall be considered non-compliant with this section, but offering a smart phone app to directly dispatch the service is encouraged as a supplement to the posted number.

Pedestrians shall not be required to present any form of payment for the service, and shall not be required to provide any form of identification other than their name.

The Contractor shall install notification signage and Audible Warning Devices at pedestrian path closure points to notify pedestrians of the Pedestrian Transport Service, instruct them how to dispatch the service (by either texting or calling the posted number), and where to wait. Both the Audible Warning Devices and notification signage shall convey the same message and be approved by the Engineer.

The Pedestrian Transport Service shall operate at a prudent speed and have designated, safe, accessible, and traversable areas for pedestrians to wait for the pedestrian transport vehicle. There shall be a location for the Pedestrian Transport Service to safely pull the transport vehicle off the roadway traffic lane or into a closed traffic lane to load or unload passengers. Pedestrians with ADA needs shall not be unloaded in a location where the surface or facility is not accessible or traversable.

# TC-6

I-5711

Alamance County

If flaggers are present on the job, the flaggers shall direct pedestrians to use the Pedestrian Transport Service to pass through or around the work zone.

## Measurement and Payment

*Pedestrian Transport Service (per trip)* will be measured and paid as the actual number of completed trips provided to pedestrians. Multiple pedestrians transported using a single trip will be paid as a single trip. No direct payment will be made for the responsible individual dispatching the vehicle, the smart phone app, pedestrian loading and unloading areas, or notification signage as these items will be considered incidental to the Pedestrian Transport Service.

*Audible Warning Devices* will be measured and paid under the ADA Compliant Pedestrian Traffic Control Devices special provision.

Payment will be made under:

<b>Pay Item</b>	<b>Pay Unit</b>
Pedestrian Transport Service (per trip)	Each

PROJECT SPECIAL PROVISIONS  
LIGHTING

**1.00 DESCRIPTION**

The work covered by this Section consists of relocating existing light poles and placing those relocated poles into satisfactory operating condition roadway lighting at locations shown on the plans. Perform all work in accordance with these Special Provisions, the Plans, the National Electrical Code, and North Carolina Department of Transportation "Standard Specifications for Roads and Structures" (*2018 Standard Specifications*).

Perform all work in conformance with Division 14 of the *2018 Standard Specifications* except as modified or added to by these Special Provisions. Install all bore pits outside the clear zone, as defined in the AASHTO Roadside Design Guide or as directed by the Engineer.

In addition to the requirements of Division 1400, other specific Sections of the *2018 Standard Specifications* applicable to the work on this project are listed below.

Section 1409	Electrical Duct
Section 1410	Feeder Circuits
Section 1411	Electrical Junction Boxes

**2.00 COORDINATION WITH STATEWIDE LIGHTING MAINTENANCE FIRM****2.10 DESCRIPTION**

The existing lighting system installed at the I-85 & SR 1007 (Mebane Oaks Rd) interchange is being monitored and maintained by Brady/Trane Services (Brady) under a Statewide service agreement. As part of the service agreement with Brady, a smart lighting control system (GE LightGrid) has been installed at this interchange to monitor the power usage and status of the lighting system. The smart lighting control system consists of a wireless gateway installed at the control panel location and smart nodes installed on each luminaire.

The Contractor shall coordinate with Brady at 919-232-5764 or [warranty.request@bradyservices.com](mailto:warranty.request@bradyservices.com) to have Brady turn the smart lighting control system on and off for the roadway lighting system reconfiguration, installation and testing, troubleshoot communication issues and incorporate new smart nodes installed on new luminaires into the LightGrid infrastructure. Brady shall bill the contractor directly for these services.

**2.20 MATERIALS**

No materials are required for this section.

**2.30 CONSTRUCTION METHODS**

As a function of the LightGrid system, the Contractor is unable to turn the lights on for testing during the day using the Hand-Off-Auto switch in the existing control panel. The existing

luminaires are powered 24/7 and the smart node installed on each luminaire has an integral photocontrol, preventing the luminaire from operating during daylight hours.

The Contractor shall notify Brady at least two weeks prior to beginning the construction work for the relocation of the existing SA poles. Brady will remotely turn all of the lights on for 24/7 operation for the duration of the lighting construction. This will allow the Contractor to turn the lighting circuits on and off during the day via the existing breakers in the existing control panel. When not in conflict and where construction allows, the lighting circuits shall be energized at night.

The Contractor shall notify Brady again when work is complete. At that point Brady will remotely confirm that there is communication between the original smart nodes, the newly installed smart nodes and the gateway, and return the system to normal dusk to dawn operation.

In the event that this reconfiguration project causes a communication failure of some or all smart nodes or the gateway, the Contractor shall coordinate with Brady to troubleshoot and resolve the failure.

#### 2.40 MEASUREMENT AND PAYMENT

The Contractor will be reimbursed by the Department for the actual verified cost of charges by Brady for LightGrid service charges. The service charges may include: efforts by Brady/Trane Services to place the GE LightGrid system into 24/7 operation and return the system to normal dusk to dawn operation and efforts by Brady to troubleshoot communication issues with the LightGrid system.

### **3.00 LUMINAIRE STORAGE**

#### 3.10 DESCRIPTION

The work covered in this section consists of providing all equipment, labor, materials and transportation necessary to transport and store LED luminaires and LightGrid smart nodes at a bonded and climate controlled warehouse facility.

#### 3.20 MATERIALS

The Contractor shall provide pallets and straps for storing and transporting the luminaire and smart nodes.

#### 3.30 CONSTRUCTION METHODS

Should storage of the LED luminaires and corresponding smart nodes be necessary during the project, the Contractor is required to store the luminaires and smart nodes in a bonded, climate controlled warehouse facility.

The Contractor shall securely strap the luminaires with smart nodes to a pallet, and transport the pallet(s) to the warehouse facility. If the smart nodes are removed from the luminaires during storage, the Contractor must institute a tagging system so that the same smart node can be reinstalled on the same luminaire. The Contractor shall provide proof to the Department that a bonded and climate controlled warehouse is being used. Bonding and climate control are required in order for the Department to maintain the warranty provided by Brady for any of the existing luminaires and smart nodes which are reused and reinstalled as part of this project.

When luminaires are to be reinstalled, the Contractor shall retrieve the luminaires and smart nodes from the warehouse facility and reinstall.

**3.40 MEASUREMENT AND PAYMENT**

The luminaires to be stored and reinstalled will be paid for at the contract lump sum unit price “Luminaire Storage”. Such price and payment will be considered full compensation for storing the removed luminaires and smart nodes in a bonded, climate controlled warehouse. It also includes transportation of the luminaires to and from the warehouse.

Payment will be made under:

Luminaire Storage.....Lump Sum

**4.00 RELOCATE LIGHT STANDARDS**

**4.10 DESCRIPTION**

The work covered by this section consists of providing all equipment, labor and materials necessary to relocate an existing light standard to a new foundation at locations shown on the plans. The standard to be relocated may be near the proposed final location, or may be one removed from another location. Refer to the plans and the section of these provisions titled “Remove Single Arm Light Standards” for more information. This section also includes storage of materials to be reused. Construction of a new foundation is not included in this section.

**4.20 MATERIALS**

Reuse existing materials, including the light standard, breakaway base and arm. Shims and washers may be reused, but new connecting bolts are required. Replace materials that are to be reused if they are damaged during relocation. Materials damaged during relocation will be replaced with new materials at no additional cost to the Department.

The Contractor is responsible for the storage and protection of the reused materials against loss or damage.

Contractor shall provide new SOOW cord and breakaway fuse holders for all relocated poles.

4.30 CONSTRUCTION METHODS

See section 5.00 of these special provisions for details on pole removal. Reassemble and reinstall light standards on a new foundation and reuse the existing breakaway base. Replace the connecting bolts joining the standard to the breakaway base and attachment hardware for the standard-to-arm connection. Use rope or web slings when hoisting or lifting the light standard, to prevent damage or marking. If the light standards are to be stored between dismounting and reinstalling, provide proper transportation and supports to prevent warping. Provide protection against the elements.

Abandon or remove the conductors and conduit as required by construction. Refer to Standard Specifications Section 1400-10. Install new circuitry inside the standard and install new feeder circuitry as shown on the plans.

Install new SOOW cord inside the standard from the luminaire to the breakaway fuse holders. Also replace breakaway fuse holders with new.

4.40 MEASUREMENT AND PAYMENT

The quantity of relocated light standards to be paid for will be the actual number, which have been installed at proposed locations in a satisfactory manner and have been accepted by the Engineer.

Relocated light standards measured as provided above will be paid for at the contract unit bid price per each "Relocate Light Standard". Such price and payment will be considered full compensation for reassembly of standard and arm, installing new connecting bolts, connection of new circuitry, new SOOW cord, new breakaway fuse holders and all incidentals necessary to complete the work.

Payment will be made under:

Relocate Light Standard ..... Each

5.00 REMOVE SINGLE ARM LIGHT STANDARDS

5.10 DESCRIPTION

The work covered by this section consists of the removal of existing single arm metal light standards on breakaway bases and concrete foundations at locations shown on the plans. The standards are less than 50' mounting height and are attached to the foundations with anchor bolts. The removed poles shall be reinstalled in locations shown on the plans.

The Contractor is responsible for the storage and protection of the reused materials against loss or damage.

Concrete foundations to be removed or abandoned may be located in areas where, due to knockdowns, there are no light standards to be removed.

## 5.20 MATERIALS

No materials are required for this work except such miscellaneous items as tape and terminal devices to dead-end circuits serving the light standards.

## 5.30 CONSTRUCTION METHODS

Maintain operation of the existing lighting system until such time that it becomes in conflict with the actual construction work, or it becomes a hazard to traffic as determined by the Engineer.

Coordinate work with the NC DOT Traffic Services Supervisor to assure that circuits can be de-energized where and when necessary.

If luminaires are to be removed as part of this work, refer to Section 3.00 of these special provisions for luminaire storage requirements.

Remove light standard and arms, couplings, anchor nuts, washers, transformer bases with doors and connecting bolts and fuse holders. Removed items shall be stored and reused.

Remove or abandon existing concrete light standard foundations as defined in Standard Specifications Section 1400-10. Dispose of the removed concrete, reinforcing steel and anchor bolts in a manner acceptable to the Engineer. Backfill the holes with suitable material and compact backfill as required.

Abandon or remove the conductors and the conduit for the removed light standards as shown on the plans. Refer to Standard Specifications Section 1400-10.

## 5.40 MEASUREMENT AND PAYMENT

The quantity of removed light standards to be paid for will be the actual number which have been dismantled from existing foundations and stored in good condition.

The quantity of removed foundations to be paid for will be the actual number which have been removed or abandoned and accepted.

The removed light standards measured as provided above will be paid for at the contract unit price per each "Remove Single Arm Light Standard". Such price and payment will be considered full compensation for disconnecting circuitry, disassembly of the shaft, arm, fuse holders and transformer base, transportation and storage of the light standard.

The removed foundations measured as provided above will be paid for at the contract unit price per each "Remove Light Standard Foundation". Such price and payment will be considered full compensation for removing or abandoning foundation concrete, reinforcing steel and anchor bolts. It also includes backfilling the holes with suitable material and compaction the backfill material as required.



Payment will be made under:

Remove Single Arm Light Standard.....Each  
Remove Light Standard Foundation.....Each



DocuSigned by:

*Roger Kluckman* 1/21/2021

A47FB0E0B26E420...

DOCUMENT NOT CONSIDERED FINAL  
UNLESS ALL SIGNATURES COMPLETED

PROJECT SPECIAL PROVISIONS

Utility Construction

	<b>alley, williams, carmen &amp; king, inc.</b>	
	<b>ENGINEERS, ARCHITECTS &amp; SURVEYORS</b>	
	740 chapel hill road	p.o. box 1179
	burlington, n.c. 27215	336/226-5534
Firm's Engineering License No. F-0203		



2/11/2020

(Seal)

The proposed utility construction shall meet the applicable requirements of the NCDOT Department of Transportation’s “Standard Specifications for Roads and Structures” dated January 2018 as well as the City of Mebane Standard Specifications. In the event the two specifications conflict, the more restrictive specification shall rule.

**Revise the 2018 Standard Specifications as follows:**

**Page 15-1; Sub-article 1500-2, Cooperation with the Utility Owner, paragraph 2:**

The utility owner is the City of Mebane. The contact person is Kyle Smith and he can be reached by phone at 336-213-2746.

**Page 15-2; Sub-article 1500-9, Placing pipelines into service, paragraph 1:**

The contractor shall have NCDOT improvements field located prior to making taps to the existing water line. Tapping sleeve, insert valve, and concrete thrust restraint locations shall be evaluated with proposed finished grade to verify no conflicts exist prior to making taps. Field adjustment of taps may be required to provide a minimum of three feet of cover over existing/proposed water line.

**Page 15-8; Section 1515-3(A).** The Contractor's attention is directed to this section. The 12" ductile iron Insert Valve shall be an epoxy coated (min 8 mils) Resilient Wedge Gate Valve designed for use in potable water systems and shall have a maximum working pressure of 250 psi. The design will allow the valve to be installed into an existing pressurized pipeline while maintaining constant pressure and normal water service. The ductile iron body, bonnet and wedge provide strength and a pressure rating that meets or exceeds the requirements of AWWA C515.

The resilient wedge shall seat on the valve body and not the pipe to obtain the optimum seating and flow control results. The resilient wedge shall be totally independent of the carrier pipe and shall not come into contact with the carrier pipe or depend on the carrier pipe to create a seal. Pressure equalization on the down or upstream side of the closed wedge shall not be necessary to open the valve. The wedge shall be symmetrical and seal equally well with flow in either direction. The resilient wedge must ride inside the body channels to maintain wedge alignment throughout its travel to achieve maximum fluid control regardless of high or low flow pressure or velocity.

The valve shall have a Non-Rising Stem (NRS) with AWWA standard turns and shall be operated by a 2" square wrench nut and shall open by turning counter clockwise. All parts and components to be exclusively and completely assembled, manufactured, machined and costed in the USA.

**Measurement and Payment:**

Payment for 12" Insert Valve shall be per each 12" Insert Valve installed, and paid for under the contract price for "12" Insert Valve". Such price and payments will be full compensation for all labor, materials, excavation, backfilling, concrete thrust blocking and any incidentals necessary to complete the work, as required.

**Pay Item:**

12" Insert Valve

**Pay Unit**

Each

**PROJECT SPECIAL PROVISIONS**  
Utilities by Others (UbO)



**General:**

The following utility companies have facilities that will be in conflict with the construction of this project:

- A. Duke Energy – Power (Distribution)
- B. Piedmont EMC – Power (Distribution)
- C. PSNC – Gas (Distribution)
- D. CenturyLink – Communications
- E. Spectrum – Communications
- F. Level 3 – Communications

The conflicting facilities of these concerns will be adjusted prior to the date of availability, unless otherwise noted and are therefore listed in these special provisions for the benefit of the Contractor. All utility work listed herein will be done by the utility owners. All utilities are shown on the plans from the best available information.

The Contractor’s attention is directed to Article 105.8 of the Standard Specifications.

**Utilities Requiring Adjustment:**

Utility relocations are shown on the Utilities by Others Plans.

**A) Duke Energy – Power (Distribution)**

- 1) Duke Energy will complete relocation of their facilities on UO2 and UO3 by April 5, 2021.
- 2) Duke Energy will complete the relocation of their facilities within a 6-week timeframe.
- 3) Contact person for Duke Energy is Ms. Cynthia Ball at (919) 278-2529 or [Cynthia.ball@duke-energy.com](mailto:Cynthia.ball@duke-energy.com)

PROJECT SPECIAL PROVISIONS  
Utilities by Others (UbO)

**B) Piedmont EMC – Power (Distribution)**

- 1) Piedmont E.M.C. will complete the relocation of their facilities on UO3 and UO4 by April 26, 2021.
- 2) Piedmont E.M.C. will complete the relocation of their facilities within a 6-week timeframe.
- 3) Contact person for Piedmont EMC is Mr. Ronald Hurdle at (336) 421-1296 or [Ronald.hurdle@pemc.coop](mailto:Ronald.hurdle@pemc.coop)

**C) PSNC – Gas (Distribution)**

- 1) PSNC will complete the relocation of facilities on UO2 by February 28, 2021.
- 2) PSNC’s field adjustment to facilities on UO3 will be completed by March 26, 2021.
- 3) Contact person for PSNC is Ms. Ronda Lemon at (919) 367-2755 or [Ronda.lemon@dominionenergy.com](mailto:Ronda.lemon@dominionenergy.com)

**D) CenturyLink – Communications**

- 1) CenturyLink will complete the relocation of their facilities on UO2 by February 12, 2021.
- 2) CenturyLink will complete the relocation of their facilities on UO3 and UO4 by May 10, 2021.
- 3) Contact person for CenturyLink is Mr. Rod Medlin at (252) 413-7711 or [Rod.M.Medlin@centurylink.com](mailto:Rod.M.Medlin@centurylink.com)

**E) Spectrum – Communications**

- 1) Spectrum will complete relocation of their facilities 4-weeks after Duke Energy Distribution on UO2 by May 3, 2021. Date is dependent on Duke Energy completing their relocations.
- 2) Spectrum will complete relocation of their facilities 6-weeks after Piedmont E.M.C. on UO3 and UO4 by June 7, 2021, Date is dependent on Piedmont E.M.C. completing their relocations.
- 3) Contact person for Spectrum is Mr. Roger Stanfield at (336) 217-3460 or [Roger.stanfield@charter.com](mailto:Roger.stanfield@charter.com)

PROJECT SPECIAL PROVISIONS

Utilities by Others

**F) Level 3 – Communications**

- 1) Level 3 will complete the relocation of their facilities on UO2 by March 1, 2021.
- 2) Level 3 will complete the relocation of their facilities within a 2-week timeframe.
- 3) Contact person for Level 3 is Mr. Brian Walker at (919) 710-8893 or [brian2.walker@lumen.com](mailto:brian2.walker@lumen.com)

**Project Special Provisions  
Erosion Control**

**STABILIZATION REQUIREMENTS:**

(4-30-2019)

Stabilization for this project shall comply with the time frame guidelines as specified by the NCG-010000 general construction permit effective April 1, 2019 issued by the North Carolina Department of Environmental Quality Division of Water Resources. Temporary or permanent ground cover stabilization shall occur within 7 calendar days from the last land-disturbing activity, with the following exceptions in which temporary or permanent ground cover shall be provided in 14 calendar days from the last land-disturbing activity:

- Slopes between 2:1 and 3:1, with a slope length of 10 ft. or less
- Slopes 3:1 or flatter, with a slope of length of 50 ft. or less
- Slopes 4:1 or flatter

The stabilization timeframe for High Quality Water (HQW) Zones shall be 7 calendar days with no exceptions for slope grades or lengths. High Quality Water Zones (HQW) Zones are defined by North Carolina Administrative Code 15A NCAC 04A.0105 (25). Temporary and permanent ground cover stabilization shall be achieved in accordance with the provisions in this contract and as directed.

**SEEDING AND MULCHING:**

**(East)**

The kinds of seed and fertilizer, and the rates of application of seed, fertilizer, and limestone, shall be as stated below. During periods of overlapping dates, the kind of seed to be used shall be determined. All rates are in pounds per acre.

All Roadway Areas

<b>March 1 - August 31</b>		<b>September 1 - February 28</b>	
50#	Tall Fescue	50#	Tall Fescue
10#	Centipede	10#	Centipede
25#	Bermudagrass (hulled)	35#	Bermudagrass (unhulled)
500#	Fertilizer	500#	Fertilizer
4000#	Limestone	4000#	Limestone

Waste and Borrow Locations

<b>March 1 - August 31</b>		<b>September 1 - February 28</b>	
75#	Tall Fescue	75#	Tall Fescue
25#	Bermudagrass (hulled)	35#	Bermudagrass (unhulled)
500#	Fertilizer	500#	Fertilizer
4000#	Limestone	4000#	Limestone

Note: 50# of Bahiagrass may be substituted for either Centipede or Bermudagrass only upon Engineer's request.

Approved Tall Fescue Cultivars

06 Dust	Escalade	Justice	Serengeti
2 <sup>nd</sup> Millennium	Essential	Kalahari	Shelby
3 <sup>rd</sup> Millennium	Evergreen 2	Kitty Hawk 2000	Sheridan
Apache III	Falcon IV	Legitimate	Signia
Avenger	Falcon NG	Lexington	Silver Hawk
Barlexas	Falcon V	LSD	Sliverstar
Barlexas II	Faith	Magellan	Shenandoah Elite
Bar Fa	Fat Cat	Matador	Sidewinder
Barrera	Festnova	Millennium SRP	Skyline
Barrington	Fidelity	Monet	Solara
Barrobusto	Finelawn Elite	Mustang 4	Southern Choice II
Barvado	Finelawn Xpress	Ninja 2	Speedway
Biltmore	Finesse II	Ol' Glory	Spyder LS
Bingo	Firebird	Olympic Gold	Sunset Gold
Bizem	Firecracker LS	Padre	Taccoa
Blackwatch	Firenza	Patagonia	Tanzania
Blade Runner II	Five Point	Pedigree	Trio
Bonsai	Focus	Picasso	Tahoe II
Braveheart	Forte	Piedmont	Talladega
Bravo	Garrison	Plantation	Tarheel
Bullseye	Gazelle II	Proseeds 5301	Terrano
Cannavaro	Gold Medallion	Prospect	Titan ltd
Catalyst	Grande 3	Pure Gold	Titanium LS
Cayenne	Greenbrooks	Quest	Tracer
Cessane Rz	Greenkeeper	Raptor II	Traverse SRP
Chipper	Gremlin	Rebel Exeda	Tulsa Time
Cochise IV	Greystone	Rebel Sentry	Turbo
Constitution	Guardian 21	Rebel IV	Turbo RZ
Corgi	Guardian 41	Regiment II	Tuxedo RZ
Corona	Hemi	Regenerate	Ultimate
Coyote	Honky Tonk	Rendition	Venture
Darlington	Hot Rod	Rhambler 2 SRP	Umbrella
Davinci	Hunter	Rembrandt	Van Gogh
Desire	Inferno	Reunion	Watchdog
Dominion	Innovator	Riverside	Wolfpack II
Dynamic	Integrity	RNP	Xtremegreen
Dynasty	Jaguar 3	Rocket	
Endeavor	Jamboree	Scorpion	



On cut and fill slopes 2:1 or steeper Centipede shall be applied at the rate of 5 pounds per acre and add 20# of Sericea Lespedeza from January 1 - December 31.

Fertilizer shall be 10-20-20 analysis. A different analysis of fertilizer may be used provided the 1-2-2 ratio is maintained and the rate of application adjusted to provide the same amount of plant food as a 10-20-20 analysis and as directed.

#### **NUTRIENT MANAGEMENT TRAINING REQUIREMENTS:**

The person(s) responsible for applying fertilizer or person(s) conducting the application of fertilizer on this project within the Jordan Lake or Falls Lake Watershed shall complete the following web-based training prior to performing this work:

<http://www.jordanlake.org/web/jordanlake/fertilizer-management>

A certificate of completion must be presented by the person(s) responsible for fertilizer application or person(s) conducting the application of fertilizer prior to performing fertilizer application on the project within the limits of the Jordan Lake or Fall Lake Watershed.

#### **TEMPORARY SEEDING:**

Fertilizer shall be the same analysis as specified for *Seeding and Mulching* and applied at the rate of 400 pounds and seeded at the rate of 50 pounds per acre. Sweet Sudan Grass, German Millet or Browntop Millet shall be used in summer months and Rye Grain during the remainder of the year. The Engineer will determine the exact dates for using each kind of seed.

#### **FERTILIZER TOPDRESSING:**

Fertilizer used for topdressing on all roadway areas except slopes 2:1 and steeper shall be 10-20-20 grade and shall be applied at the rate of 500 pounds per acre. A different analysis of fertilizer may be used provided the 1-2-2 ratio is maintained and the rate of application adjusted to provide the same amount of plant food as 10-20-20 analysis and as directed.

Fertilizer used for topdressing on slopes 2:1 and steeper and waste and borrow areas shall be 16-8-8 grade and shall be applied at the rate of 500 pounds per acre. A different analysis of fertilizer may be used provided the 2-1-1 ratio is maintained and the rate of application adjusted to provide the same amount of plant food as 16-8-8 analysis and as directed.

#### **SUPPLEMENTAL SEEDING:**

The kinds of seed and proportions shall be the same as specified for *Seeding and Mulching*, with the exception that no centipede seed will be used in the seed mix for supplemental seeding. The rate of application for supplemental seeding may vary from 25# to 75# per acre. The actual rate per acre will be determined prior to the time of topdressing and the Contractor will be notified in writing of the rate per acre, total quantity needed, and areas on which to apply the supplemental seed. Minimum tillage equipment, consisting of a sod seeder shall be used for incorporating seed

into the soil as to prevent disturbance of existing vegetation. A clodbuster (ball and chain) may be used where degree of slope prevents the use of a sod seeder.

**MOWING:**

The minimum mowing height on this project shall be 4 inches.

**LAWN TYPE APPEARANCE:**

All areas adjacent to lawns must be hand finished as directed to give a lawn type appearance. Remove all trash, debris, and stones ¾" and larger in diameter or other obstructions that could interfere with providing a smooth lawn type appearance. These areas shall be reseeded to match their original vegetative conditions, unless directed otherwise by the Field Operations Engineer.

**RESPONSE FOR EROSION CONTROL:**

**Description**

Furnish the labor, materials, tools and equipment necessary to move personnel, equipment, and supplies to the project necessary for the pursuit of any or all of the following work as shown herein, by an approved subcontractor.

<b>Section</b>	<b>Erosion Control Item</b>	<b>Unit</b>
1605	Temporary Silt Fence	LF
1606	Special Sediment Control Fence	LF/TON
1615	Temporary Mulching	ACR
1620	Seed - Temporary Seeding	LB
1620	Fertilizer - Temporary Seeding	TN
1631	Matting for Erosion Control	SY
SP	Coir Fiber Mat	SY
1640	Coir Fiber Baffles	LF
SP	Permanent Soil Reinforcement Mat	SY
1660	Seeding and Mulching	ACR
1661	Seed - Repair Seeding	LB
1661	Fertilizer - Repair Seeding	TON
1662	Seed - Supplemental Seeding	LB
1665	Fertilizer Topdressing	TON
SP	Safety/Highly Visible Fencing	LF
SP	Response for Erosion Control	EA

### **Construction Methods**

Provide an approved subcontractor who performs an erosion control action as described in the NPDES Inspection Form SPPP30. Each erosion control action may include one or more of the above work items.

### **Measurement and Payment**

*Response for Erosion Control* will be measured and paid for by counting the actual number of times the subcontractor moves onto the project, including borrow and waste sites, and satisfactorily completes an erosion control action described in Form 1675. The provisions of Article 104-5 of the *Standard Specifications* will not apply to this item of work.

Payment will be made under:

<b>Pay Item</b>	<b>Pay Unit</b>
Response for Erosion Control	Each

### **MINIMIZE REMOVAL OF VEGETATION:**

The Contractor shall minimize removal of vegetation within project limits to the maximum extent practicable. Vegetation along stream banks and adjacent to other jurisdictional resources outside the construction limits shall only be removed upon approval of Engineer. No additional payment will be made for this minimization work.

### **STOCKPILE AREAS:**

The Contractor shall install and maintain erosion control devices sufficient to contain sediment around any erodible material stockpile areas as directed.

### **ACCESS AND HAUL ROADS:**

At the end of each working day, the Contractor shall install or re-establish temporary diversions or earth berms across access/haul roads to direct runoff into sediment devices. Silt fence sections that are temporarily removed shall be reinstalled across access/haul roads at the end of each working day.

### **CONSTRUCTION MATERIALS MANAGEMENT**

(3-19-19) (rev. 04-27-19)

#### **Description**

The requirements set forth shall be adhered to in order to meet the applicable materials handling requirements of the NCG010000 permit. Structural controls installed to manage construction materials stored or used on site shall be shown on the E&SC Plan. Requirements for handling materials on construction sites shall be as follows:

**Polyacrylamides (PAMS) and Flocculants**

Polyacrylamides (PAMS) and flocculants shall be stored in leak-proof containers that are kept under storm-resistant cover or surrounded by secondary containment structures designed to protect adjacent surface waters. PAMS or other flocculants used shall be selected from the NC DWR List of Approved PAMS/Flocculants. The concentration of PAMS and other flocculants used shall not exceed those specified in the NC DWR List of Approved PAMS/Flocculants and in accordance with the manufacturer's instructions. The NC DWR List of Approved PAMS/Flocculants is available at:

[https://files.nc.gov/ncdeq/Water%20Quality/Environmental%20Sciences/ATU/ApprovedPAMS4\\_1\\_2017.pdf](https://files.nc.gov/ncdeq/Water%20Quality/Environmental%20Sciences/ATU/ApprovedPAMS4_1_2017.pdf)

**Equipment Fluids**

Fuels, lubricants, coolants, and hydraulic fluids, and other petroleum products shall be handled and disposed of in a manner so as not to enter surface or ground waters and in accordance with applicable state and federal regulations. Equipment used on the site must be operated and maintained properly to prevent discharge of fluids. Equipment, vehicle, and other wash waters shall not be discharged into E&SC basins or other E&SC devices. Alternative controls should be provided such that there is no discharge of soaps, solvents, or detergents.

**Waste Materials**

Construction materials and land clearing waste shall be disposed of in accordance with North Carolina General Statutes, Chapter 130A, Article 9 - Solid Waste Management, and rules governing the disposal of solid waste (15A NCAC 13B). Areas dedicated for managing construction material and land clearing waste shall be at least 50 feet away from storm drain inlets and surface waters unless it can be shown that no other alternatives are reasonably available. Paint and other liquid construction material waste shall not be dumped into storm drains. Paint and other liquid construction waste washouts should be located at least 50 feet away from storm drain inlets unless there is no alternative. Other options are to install lined washouts or use portable, removable bags or bins. Hazardous or toxic waste shall be managed in accordance with the federal Resource Conservation and Recovery Act (RCRA) and NC Hazardous Waste Rules at 15A NCAC, Subchapter 13A. Litter and sanitary waste shall be managed in a manner to prevent it from entering jurisdictional waters and shall be disposed of offsite.

**Herbicide, Pesticide, and Rodenticides**

Herbicide, pesticide, and rodenticides shall be stored and applied in accordance with the Federal Insecticide, Fungicide, and Rodenticide Act, North Carolina Pesticide Law of 1971 and labeling restrictions.

**Concrete Materials**

Concrete materials onsite, including excess concrete, must be controlled and managed to avoid contact with surface waters, wetlands or buffers. No concrete or cement slurry shall be discharged from the site. (Note that discharges from onsite concrete plants require coverage under a separate NPDES permit – NCG140000.) Concrete wash water shall be managed in accordance with the *Concrete Washout Structure* provision. Concrete slurry shall be managed and disposed of in accordance with *NCDOT DGS and HOS DCAR Distribution of Class A Residuals Statewide* (Permit No. WQ0035749). Any hardened concrete residue will be disposed of, or recycled on site, in accordance with state solid waste regulations.

**Earthen Material Stock Piles**

Earthen material stock piles shall be located at least 50 feet away from storm drain inlets and surface waters unless it can be shown that no other alternatives are reasonably available.

**Measurement and Payment**

Conditions set within the *Construction Materials Management* provision are incidental to the project for which no direct compensation will be made.

**WASTE AND BORROW SOURCES:**

Payment for temporary erosion control measures, except those made necessary by the Contractor's own negligence or for his own convenience, will be paid for at the appropriate contract unit price for the devices or measures utilized in borrow sources and waste areas.

No additional payment will be made for erosion control devices or permanent seeding and mulching in any commercial borrow or waste pit. All erosion and sediment control practices that may be required on a commercial borrow or waste site will be done at the Contractor's expense.

All offsite Staging Areas, Borrow and Waste sites shall be in accordance with "Borrow and Waste Site Reclamation Procedures for Contracted Projects" located at:

<https://connect.ncdot.gov/resources/roadside/FieldOperationsDocuments/ContractedReclamationProcedures.pdf>

All forms and documents referenced in the "Borrow and Waste Site Reclamation Procedures for Contracted Projects" shall be included with the reclamation plans for offsite staging areas, and borrow and waste sites.

**TEMPORARY DIVERSION:**

This work consists of installation, maintenance, and cleanout of *Temporary Diversions* in accordance with Section 1630 of the *Standard Specifications*. The quantity of excavation for

installation and cleanout will be measured and paid for as *Silt Excavation* in accordance with Article 1630-3 of the *Standard Specifications*.

### **SAFETY FENCE AND JURISDICTIONAL FLAGGING:**

#### **Description**

*Safety Fence* shall consist of furnishing materials, installing and maintaining polyethylene or polypropylene fence along the outside riparian buffer, wetland, or water boundary, or other boundaries located within the construction corridor to mark the areas that have been approved to infringe within the buffer, wetland, endangered vegetation, culturally sensitive areas or water. The fence shall be installed prior to any land disturbing activities.

Interior boundaries for jurisdictional areas noted above shall be delineated by stakes and highly visible flagging.

Jurisdictional boundaries at staging areas, waste sites, or borrow pits, whether considered outside or interior boundaries shall be delineated by stakes and highly visible flagging.

#### **Materials**

##### **(A) Safety Fencing**

Polyethylene or polypropylene fence shall be a highly visible preconstructed safety fence approved by the Engineer. The fence material shall have an ultraviolet coating.

Either wood posts or steel posts may be used. Wood posts shall be hardwood with a wedge or pencil tip at one end, and shall be at least 5 ft. in length with a minimum nominal 2" x 2" cross section. Steel posts shall be at least 5 ft. in length, and have a minimum weight of 0.85 lb/ft of length.

##### **(B) Boundary Flagging**

Wooden stakes shall be 4 feet in length with a minimum nominal 3/4" x 1-3/4" cross section. The flagging shall be at least 1" in width. The flagging material shall be vinyl and shall be orange in color and highly visible.

#### **Construction Methods**

No additional clearing and grubbing is anticipated for the installation of this fence. The fence shall be erected to conform to the general contour of the ground.

##### **(A) Safety Fencing**

Posts shall be set at a maximum spacing of 10 ft., maintained in a vertical position and hand set or set with a post driver. Posts shall be installed a minimum of 2 ft. into the ground. If hand set, all

backfill material shall be thoroughly tamped. Wood posts may be sharpened to a dull point if power driven. Posts damaged by power driving shall be removed and replaced prior to final acceptance. The tops of all wood posts shall be cut at a 30-degree angle. The wood posts may, at the option of the Contractor, be cut at this angle either before or after the posts are erected.

The fence geotextile shall be attached to the wood posts with one 2" galvanized wire staple across each cable or to the steel posts with wire or other acceptable means.

Place construction stakes to establish the location of the safety fence in accordance with Article 105-9 or Article 801-1 of the *Standard Specifications*. No direct pay will be made for the staking of the safety fence. All stakeouts for safety fence shall be considered incidental to the work being paid for as "Construction Surveying", except that where there is no pay item for construction surveying, all safety fence stakeout will be performed by state forces.

The Contractor shall be required to maintain the safety fence in a satisfactory condition for the duration of the project as determined by the Engineer.

(B) Boundary Flagging

Boundary flagging delineation of interior boundaries shall consist of wooden stakes on 25 feet maximum intervals with highly visible orange flagging attached. Stakes shall be installed a minimum of 6" into the ground. Interior boundaries may be staked on a tangent that runs parallel to buffer but must not encroach on the buffer at any location. Interior boundaries of hand clearing shall be identified with a different colored flagging to distinguish it from mechanized clearing.

Boundary flagging delineation of interior boundaries will be placed in accordance with Article 105-9 or Article 801-1 of the *Standard Specifications*. No direct pay will be made for delineation of the interior boundaries. This delineation will be considered incidental to the work being paid for as *Construction Surveying*, except that where there is no pay item or construction surveying the cost of boundary flagging delineation shall be included in the unit prices bid for the various items in the contract. Installation for delineation of all jurisdictional boundaries at staging areas, waste sites, or borrow pits shall consist of wooden stakes on 25 feet maximum intervals with highly visible orange flagging attached. Stakes shall be installed a minimum of 6" into the ground. Additional flagging may be placed on overhanging vegetation to enhance visibility but does not substitute for installation of stakes.

Installation of boundary flagging for delineation of all jurisdictional boundaries at staging areas, waste sites, or borrow pits shall be performed in accordance with Subarticle 230-4(B)(5) or Subarticle 802-2(F) of the *Standard Specifications*. No direct pay will be made for this delineation, as the cost of same shall be included in the unit prices bid for the various items in the contract.

The Contractor shall be required to maintain alternative stakes and highly visible flagging in a satisfactory condition for the duration of the project as determined by the Engineer.

## Measurement and Payment

*Safety Fence* will be measured and paid as the actual number of linear feet of polyethylene or polypropylene fence installed in place and accepted. Such payment will be full compensation including but not limited to furnishing and installing fence geotextile with necessary posts and post bracing, staples, tie wires, tools, equipment and incidentals necessary to complete this work.

Payment will be made under:

<b>Pay Item</b>	<b>Pay Unit</b>
Safety Fence	Linear Foot

## SKIMMER BASIN WITH BAFFLES:

### Description

Provide a skimmer basin to remove sediment from construction site runoff at locations shown in the erosion control plans. See the Skimmer Basin with Baffles Detail sheet provided in the erosion control plans. Work includes constructing sediment basin, installation of temporary slope drain pipe and coir fiber baffles, furnishing, installation and cleanout of skimmer, providing and placing stone pad on bottom of basin underneath skimmer device, providing and placing a geotextile spillway liner, providing coir fiber mat stabilization for the skimmer outlet, disposing of excess materials, removing temporary slope drain, coir fiber baffles, geotextile liner and skimmer device, backfilling basin area with suitable material and providing proper drainage when basin area is abandoned.

### Materials

<b>Item</b>	<b>Section</b>
Stone for Erosion Control, Class B	1042
Geotextile for Soil Stabilization, Type 4	1056
Fertilizer for Temporary Seeding	1060-2
Seed for Temporary Seeding	1060-4
Seeding and Mulching	1060-4
Matting for Erosion Control	1060-8
Staples	1060-8
Coir Fiber Mat	1060-14
Temporary Slope Drain	1622-2
Coir Fiber Baffle	1640

Provide appropriately sized and approved skimmer device.

Provide Schedule 40 PVC pipe with a length of 6 ft. to attach to the skimmer and the coupling connection to serve as the arm pipe. For skimmer sizes of 2.5 in. and smaller, the arm pipe diameter shall be 1.5 inches. For skimmer sizes of 3 in. and larger, refer to manufacturer recommendation.



Provide 4" diameter Schedule 40 PVC pipe to attach to coupling connection of skimmer to serve as the barrel pipe through the earthen dam.

Anchors: Staples, stakes, or reinforcement bars shall be used as anchors.

#### Wooden Stakes:

Provide hardwood stakes 12"- 24" long with a 2" x 2" nominal square cross section. One end of the stake must be sharpened or beveled to facilitate driving through the coir fiber mat and down into the underlying soil. The other end of the stake needs to have a 1"- 2" long head at the top with a 1"- 2" notch following to catch and secure the coir fiber mat.

#### Steel Reinforcement Bars:

Provide uncoated #10 steel reinforcement bars 24" nominal length. The bars shall have a 4" diameter bend at one end with a 4" straight section at the tip to catch and secure the coir fiber mat.

#### Staples:

Provide staples made of 0.125" diameter new steel wire formed into a *u* shape not less than 12" in length with a throat of 1" in width.

### **Construction Methods**

Excavate basin according to the erosion control plans with basin surface free of obstructions, debris, and pockets of low-density material. Install temporary slope drain pipe and construct the primary spillway according to the Skimmer Basin with Baffles Detail sheet in the erosion control plans. Temporary slope drain pipe at inlet of basin may be replaced by geotextile as directed. Construct the coir fiber baffles according to *Roadway Standard Drawings* No. 1640.01 and Section 1640 of the *Standard Specifications*.

Install skimmer device according to manufacturer recommendations. Install 4" Schedule 40 PVC pipe into dam on the lower side of basin 1 ft. from the bottom of the basin and according to the detail, and extend the pipe so the basin will drain. Attach a 6 ft. arm pipe to the coupling connection and skimmer according to manufacturer recommendations. The coupling shall be rigid and non-buoyant and not exceed a diameter of 4" and 12" in length. Attach the rope included with the skimmer to the tee between the vent socket and the tube inlet, and the other end to a wooden stake or metal post. Clean out skimmer device when it becomes clogged with sediment and/or debris and is unable to float at the top of water in skimmer basin. Take appropriate measures to avoid ice accumulation in the skimmer device. Construct a stone pad of Class B stone directly underneath the skimmer device at bottom of basin. The pad shall be a minimum of 12" in height, and shall have a minimum cross sectional area of 4 ft. by 4 ft.

Line primary spillway with geotextile unrolled in the direction of flow and lay smoothly but loosely on soil surface without creases. Bury edges of geotextile in a trench at least 5" deep and

tamp firmly. If geotextile for the primary spillway is not one continuous piece of material, make horizontal overlaps a minimum of 18" with upstream geotextile overlapping the downstream geotextile. Secure geotextile with eleven gauge wire staples shaped into a *u* shape with a length of not less than 12" and a throat not less than 1" in width. Place staples along outer edges and throughout the geotextile a maximum of 3 ft. horizontally and vertically. Geotextile shall be placed to the bottom and across the entire width of the basin according to the Skimmer Basin with Baffles detail. Place sealant inside basin around barrel pipe on top of geotextile with a minimum width of 6 in.

At the skimmer outlet, provide a smooth soil surface free from stones, clods, or debris that will prevent contact of the coir fiber matting with the soil. Unroll the matting and apply without stretching such that it will lie smoothly but loosely on the soil surface. Wooden stakes, reinforcement bars, or staples may be used as anchors in accordance with the details in the plans and as directed. Place anchors across the matting at the ends approximately 1 ft. apart. Place anchors along the outer edges and down the center of the matting 3 ft. apart.

All bare side slope sections of the skimmer basin shall be seeded with a temporary or permanent seed mix as directed and in accordance with Articles 1620-3, 1620-4, 1620-5, 1660-4, 1660-5 and 1660-7 of the *Standard Specifications*. Straw or excelsior matting shall be installed on all bare side slope sections immediately upon the completion of seeding and in accordance with Article 1631-3 of the *Standard Specifications*.

### **Measurement and Payment**

*Silt Excavation* will be measured and paid for in accordance with Article 1630-4 of the *Standard Specifications*, as calculated from the typical section throughout the length of the basin as shown on the final approved plans.

*Geotextile for Soil Stabilization* will be measured and paid for in accordance with Article 270-4 of the *Standard Specifications*.

*Coir Fiber Baffles* will be measured and paid for in accordance with Article 1640-4 of the *Standard Specifications*.

\_\_\_" *Skimmer* will be measured in units of each. \_\_\_" *Skimmer* will be measured and paid for as the maximum number of each size skimmer acceptably installed and in use at any one time during the life of the project. Barrel and arm pipe, cleanout, relocation and reinstallation of \_\_\_" *Skimmer* is considered incidental to the measurement of the quantity of \_\_\_" *Skimmer* and no separate payment will be made. No separate payment shall be made if \_\_\_" *Skimmer*, barrel and/or arm pipe(s) are damaged by ice accumulation.

*Coir Fiber Mat* will be measured and paid for as the actual number of square yards measured along the surface of the ground over which coir fiber mat is installed and accepted.

*Temporary Slope Drain* will be measured and paid for in accordance with Article 1622-4 of the *Standard Specifications*.

*Stone for Erosion Control, Class \_\_* will be measured and paid for in accordance with Article 1610-4 of the *Standard Specifications*.

*Seeding and Mulching* will be measured and paid for in accordance with Article 1660-8 of the *Standard Specifications*.

*Seed for Temporary Seeding* will be measured and paid for in accordance with Article 1620-6 of the *Standard Specifications*.

*Fertilizer for Temporary Seeding* will be measured and paid for in accordance with Article 1620-6 of the *Standard Specifications*.

*Matting for Erosion Control* will be measured and paid for in accordance with Article 1631-4 of the *Standard Specifications*.

No measurement will be made for other items or for over excavation or stockpiling.

Payment will be made under:

**Pay Item**

\_\_" Skimmer  
Coir Fiber Mat

**Pay Unit**

Each  
Square Yard

**COIR FIBER WATTLES WITH POLYACRYLAMIDE (PAM):**

**Description**

Coir Fiber Wattles are tubular products consisting of coir fibers (coconut fibers) encased in coir fiber netting. Coir Fiber Wattles are used on slopes or channels to intercept runoff and act as a velocity break. Coir Fiber Wattles are to be placed at locations shown on the plans or as directed. Installation shall follow the detail provided in the plans and as directed. Work includes furnishing materials, installation of coir fiber wattles, matting installation, PAM application, and removing wattles.

**Materials**

Coir Fiber Wattle shall meet the following specifications:

100% Coir (Coconut) Fibers	
Minimum Diameter	12 in.
Minimum Density	3.5 lb/ft <sup>3</sup> +/- 10%
Net Material	Coir Fiber
Net Openings	2 in. x 2 in.
Net Strength	90 lbs.
Minimum Weight	2.6 lbs./ft. +/- 10%

Anchors: Stakes shall be used as anchors.

Wooden Stakes:

Provide hardwood stakes a minimum of 2-ft. long with a 2 in. x 2 in. nominal square cross section. One end of the stake must be sharpened or beveled to facilitate driving down into the underlying soil.

Matting shall meet the requirements of Article 1060-8 of the *Standard Specifications*, or shall meet specifications provided elsewhere in this contract.

Provide staples made of 0.125" diameter new steel wire formed into a *u* shape not less than 12" in length with a throat of 1" in width.

Polyacrylamide (PAM) shall be applied in powder form and shall be anionic or neutrally charged. Soil samples shall be obtained in areas where the wattles will be placed, and from offsite material used to construct the roadway, and analyzed for the appropriate PAM flocculant to be utilized with each wattle. The PAM product used shall be listed on the North Carolina Department of Environmental Quality Division of Water Resources web site as an approved PAM product for use in North Carolina.

**Construction Methods**

Coir Fiber Wattles shall be secured to the soil by wire staples approximately every 1 linear foot and at the end of each section of wattle. A minimum of 4 stakes shall be installed on the downstream side of the wattle with a maximum spacing of 2 linear feet along the wattle, and according to the detail. Install a minimum of 2 stakes on the upstream side of the wattle according to the detail provided in the plans. Stakes shall be driven into the ground a minimum of 10 in. with no more than 2 in. projecting from the top of the wattle. Drive stakes at an angle according to the detail provided in the plans.

Only install coir fiber wattle(s) to a height in ditch so flow will not wash around wattle and scour ditch slopes and according to the detail provided in the plans and as directed. Overlap adjoining sections of wattles a minimum of 6 in.

Installation of matting shall be in accordance with the detail provided in the plans, and in accordance with Article 1631-3 of the *Standard Specifications*, or in accordance with specifications provided elsewhere in this contract.

Apply PAM over the lower center portion of the coir fiber wattle where the water is going to flow over at a rate of 2 ounces per wattle, and 1 ounce of PAM on matting on each side of the wattle. PAM applications shall be done during construction activities after every rainfall event that is equal to or exceeds 0.50 in.

The Contractor shall maintain the coir fiber wattles until the project is accepted or until the wattles are removed, and shall remove and dispose of silt accumulations at the wattles when so directed in accordance with the requirements of Section 1630 of the *Standard Specifications*.

### Measurement and Payment

*Coir Fiber Wattles* will be measured and paid for by the actual number of linear feet of wattles which are installed and accepted. Such price and payment will be full compensation for all work covered by this section, including, but not limited to, furnishing all materials, labor, equipment and incidentals necessary to install the *Coir Fiber Wattles*.

Matting will be measured and paid for in accordance with Article 1631-4 of the *Standard Specifications*, or in accordance with specifications provided elsewhere in this contract.

*Polyacrylamide(PAM)* will be measured and paid for by the actual weight in pounds of PAM applied to the coir fiber wattles. Such price and payment will be full compensation for all work covered by this section, including, but not limited to, furnishing all materials, labor, equipment and incidentals necessary to apply the *Polyacrylamide(PAM)*.

Payment will be made under:

<b>Pay Item</b>	<b>Pay Unit</b>
Polyacrylamide(PAM)	Pound
Coir Fiber Wattle	Linear Foot

### **TEMPORARY ROCK SILT CHECK TYPE A WITH EXCELSIOR MATTING AND POLYACRYLAMIDE (PAM):**

#### **Description**

Temporary Rock Silt Checks Type A with Excelsior Matting and Polyacrylamide (PAM) are devices utilized in temporary and permanent ditches to reduce runoff velocity and incorporate PAM into the construction runoff to increase settling of sediment particles and reduce turbidity of runoff. Temporary Rock Silt Checks Type A with Excelsior Matting and PAM are to be placed at locations shown on the plans or as directed. Installation shall follow the detail provided in the plans and as directed. Work includes furnishing materials, installation of Temporary Rock Silt Checks Type A, matting installation, PAM application, and removing Temporary Rock Silt Checks Type A with Excelsior Matting and PAM.

#### **Materials**

Structural stone shall be class B stone that meets the requirements of Section 1042 of the *Standard Specifications* for Stone for Erosion Control, Class B.

Sediment control stone shall be #5 or #57 stone, which meets the requirements of Section 1005 of the *Standard Specifications* for these stone sizes.

Matting shall meet the requirements of Excelsior Matting in Subarticle 1060-8(B) of the *Standard Specifications*, or shall meet specifications provided elsewhere in this contract.

Polyacrylamide (PAM) shall be applied in powder form and shall be anionic or neutrally charged. Soil samples shall be obtained in areas where the Temporary Rock Silt Checks Type A with Excelsior Matting and PAM will be placed, and from offsite material used to construct the roadway, and analyzed for the appropriate PAM flocculant to be utilized with each Temporary Rock Silt Check Type A. The PAM product used shall be listed on the North Carolina Department of Environmental Quality Division of Water Resources web site as an approved PAM product for use in North Carolina.

### **Construction Methods**

Temporary Rock Silt Checks Type A shall be installed in accordance with Subarticle 1633-3(A) of the *Standard Specifications*, Roadway Standard Drawing No. 1633.01 and the detail provided in the plans.

Installation of matting shall be in accordance with the detail provided in the plans, and anchored by placing Class B stone on top of the matting at the upper and lower ends.

Apply PAM at a rate of 4 ounces over the center portion of the Temporary Rock Silt Checks Type A and matting where the water is going to flow over. PAM applications shall be done during construction activities and after every rainfall event that is equal to or exceeds 0.50 in.

The Contractor shall maintain the Temporary Rock Silt Checks Type A with Excelsior Matting and PAM until the project is accepted or until the Temporary Rock Silt Checks Type A with Excelsior Matting and PAM are removed, and shall remove and dispose of silt accumulations at the Temporary Rock Silt Checks Type A with Excelsior Matting and PAM when so directed in accordance with the requirements of Section 1630 of the *Standard Specifications*.

### **Measurement and Payment**

*Temporary Rock Silt Checks Type A* will be measured and paid for in accordance with Article 1633-5 of the *Standard Specifications*, or in accordance with specifications provided elsewhere in this contract.

Matting will be measured and paid for in accordance with Article 1631-4 of the *Standard Specifications*, or in accordance with specifications provided elsewhere in this contract.

*Polyacrylamide(PAM)* will be measured and paid for by the actual weight in pounds of PAM applied to the Temporary Rock Silt Checks Type A. Such price and payment will be full compensation for all work covered by this section, including, but not limited to, furnishing all materials, labor, equipment and incidentals necessary to apply the *Polyacrylamide(PAM)*.

Payment will be made under:

<b>Pay Item</b>	<b>Pay Unit</b>
Polyacrylamide(PAM)	Pound

### **COIR FIBER MAT:**

#### **Description**

Furnish material, install and maintain coir fiber mat in locations shown on the plans or in locations as directed. Work includes providing all materials, excavating and backfilling, and placing and securing coir fiber mat with stakes, steel reinforcement bars or staples as directed.

#### **Materials**

<b>Item</b>	<b>Section</b>
Coir Fiber Mat	1060-14

Anchors: Stakes, reinforcement bars, or staples shall be used as anchors.

#### Wooden Stakes:

Provide hardwood stakes 12"- 24" long with a 2" x 2" nominal square cross section. One end of the stake must be sharpened or beveled to facilitate driving through the coir fiber mat and down into the underlying soil. The other end of the stake needs to have a 1"- 2" long head at the top with a 1"- 2" notch following to catch and secure the coir fiber mat.

#### Steel Reinforcement Bars:

Provide uncoated #10 steel reinforcement bars 24" nominal length. The bars shall have a 4" diameter bend at one end with a 4" straight section at the tip to catch and secure the coir fiber mat.

#### Staples:

Provide staples made of 0.125" diameter new steel wire formed into a *u* shape not less than 12" in length with a throat of 1" in width.

#### **Construction Methods**

Place the coir fiber mat immediately upon final grading. Provide a smooth soil surface free from stones, clods, or debris that will prevent the contact of the mat with the soil. Unroll the mat and apply without stretching such that it will lie smoothly but loosely on the soil surface.

For stream relocation applications, take care to preserve the required line, grade, and cross section of the area covered. Bury the top slope end of each piece of mat in a narrow trench at least 6 in.

deep and tamp firmly. Where one roll of matting ends and a second roll begins, overlap the end of the upper roll over the buried end of the second roll so there is a 6 in. overlap. Construct check trenches at least 12 in. deep every 50 ft. longitudinally along the edges of the mat or as directed. Fold over and bury mat to the full depth of the trench, close and tamp firmly. Overlap mat at least 6 in. where 2 or more widths of mat are installed side by side.

Place anchors across the mat at the ends approximately 1 ft. apart. Place anchors along the outer edges and down the center of the mat 3 ft. apart.

Adjustments in the trenching or anchoring requirements to fit individual site conditions may be required.

### **Measurement and Payment**

*Coir Fiber Mat* will be measured and paid for as the actual number of square yards measured along the surface of the ground over which coir fiber mat is installed and accepted.

No measurement will be made for anchor items.

Payment will be made under:

#### **Pay Item**

Coir Fiber Mat

#### **Pay Unit**

Square Yard

### **CONCRETE WASHOUT STRUCTURE:**

(12-10-20)

#### **Description**

Concrete washout structures are enclosures above or below grade to contain concrete waste water and associated concrete mix from washing out ready-mix trucks, drums, pumps, or other equipment. Concrete washouts must collect and retain all the concrete washout water and solids, so that this material does not migrate to surface waters or into the ground water. These enclosures are not intended for concrete waste not associated with wash out operations.

The concrete washout structure may include constructed devices above or below ground and or commercially available devices designed specifically to capture concrete wash water.

#### **Materials**

##### **Item**

Temporary Silt Fence

##### **Section**

1605

*Safety Fence* shall meet the specifications as provided elsewhere in this contract.



Geomembrane basin liner shall meet the following minimum physical properties for low permeability; it shall consist of a polypropylene or polyethylene 10 mil thick geomembrane. If the minimum setback dimensions can be achieved the liner is not required. (5 feet above groundwater, 50 feet from top of bank of perennial stream, other surface water body, or wetland.)

### **Construction Methods**

Build an enclosed earthen berm or excavate to form an enclosure in accordance with the details and as directed.

Install temporary silt fence around the perimeter of the enclosure in accordance with the details and as directed if structure is not located in an area where existing erosion and sedimentation control devices are capable to containing any loss of sediment.

Post a sign with the words “Concrete Washout” in close proximity of the concrete washout area, so it is clearly visible to site personnel. Install safety fence as directed for visibility to construction traffic.

The construction details for the above grade and below grade concrete washout structures can be found on the following web page link:

<https://connect.ncdot.gov/resources/roadside/SoilWaterDocuments/ConcreteWashoutStructureDetail.pdf>

Alternate details for accommodating concrete washout may be submitted for review and approval.

The alternate details shall include the method used to retain and dispose of the concrete waste water within the project limits and in accordance with the minimum setback requirements. (5 feet above groundwater, 50 feet from top of bank of perennial stream, other surface water body, or wetland.)

### **Maintenance and Removal**

Maintain the concrete washout structure(s) to provide adequate holding capacity plus a minimum freeboard of 12 inches. Remove and dispose of hardened concrete and return the structure to a functional condition after reaching 75% capacity.

Inspect concrete washout structures for damage and maintain for effectiveness.

Remove the concrete washout structures and sign upon project completion. Grade the earth material to match the existing contours and permanently seed and mulch area.

**Measurement and Payment**

*Concrete Washout Structure* will be paid for per each enclosure installed in accordance with the details. If alternate details or commercially available devices are approved, then those devices will also be paid for per each approved and installed device.

*Temporary Silt Fence* will be measured and paid for in accordance with Article 1605-5 of the *Standard Specifications*.

*Safety Fence* shall be measured and paid for as provided elsewhere in this contract.

No measurement will be made for other items or for over excavation or stockpiling.

Payment will be made under:

<b>Pay Item</b>	<b>Pay Unit</b>
Concrete Washout Structure	Each

**FABRIC INSERT INLET PROTECTION DEVICE (HIGH FLOW)**

(6-29-17)

**Description**

This work shall consist of installing, maintaining, and removing *Fabric Inlet Protection Device*, of the type specified, in inlet structures (catch basins, drop inlets, etc) in areas where asphalt or concrete may prevent the proper installation of a Rock Inlet Sediment Traps Type C, or as directed.

**Materials**

The product shall be a fabric inlet protection device composed of a fitted woven polypropylene geotextile double sewn with nylon thread suspended sack. The *Fabric Inlet Protection Device* shall be manufactured to fit the opening of the catch basin or drop inlet or shall have a deflector to direct runoff from the curb opening into the fabric sack. The *Fabric Inlet Protection Device* shall have a rigid frame or support system to support the loaded weight of the product. The product shall have lifting loops for removing the device from the basin and will have dump straps attached at the bottom to facilitate the emptying of the device. The *Fabric Inlet Protection Device* shall have an overflow system to allow stormwater to enter the inlet structure and avoid ponding on the roadway when the device reaches capacity.

The stitching shall meet the following physical properties:

<b>Physical</b>	<b>Test Method</b>	<b>English</b>
Average Wide Width Strength	ASTM D-4884	165 lb/in

The fitted filter assembly shall have the following physical properties:

<b>Physical</b>	<b>Test Method</b>	<b>English</b>
Grab Tensile	ASTM D-4632	255 x 275 lbs
Minimum Puncture Strength	ASTM D-4833	125 lbs
Mullen Burst	ASTM D-3786	420 PSI
Minimum UV Resistance	ASTM D-4355	70 %.
Flow Rate	ASTM D-4491	200 gal/min/ft <sup>2</sup>
Apparent Opening	ASTM D-4751	20 US Sieve
Permittivity	ASTM D-4491	1.5 sec <sup>-1</sup>

### Construction Methods

Strictly comply with manufacturer's installation instructions and recommendations. Maintenance shall include regular daily inspections and after each qualifying rain event. The *Fabric Insert Inlet Protection Device* shall be emptied, cleaned and placed back into the basin when it reaches 50% capacity or as directed.

### Measurement and Payment

This work will be paid for at the contract unit price per *Fabric Insert Inlet Protection Device* of the type specified, complete in place and accepted. Such payment shall be full compensation for furnishing and installing the *Fabric Insert Inlet Protection Device* in accordance with this specification and for all required maintenance.

Maintenance of the device, cleanout and disposal of accumulated sediments shall be paid for by *Fabric Insert Inlet Protection Device Cleanout*.

Payment will be made under:

<b>Pay Item</b>	<b>Pay Unit</b>
Fabric Insert Inlet Protection Device	Each
Fabric Insert Inlet Protection Device Cleanout	Each

I-5711

Signals and Intelligent Transportation Systems  
Project Special Provisions  
(Version 18.4)

Prepared By: J.A.Lohr  
16-Dec-20

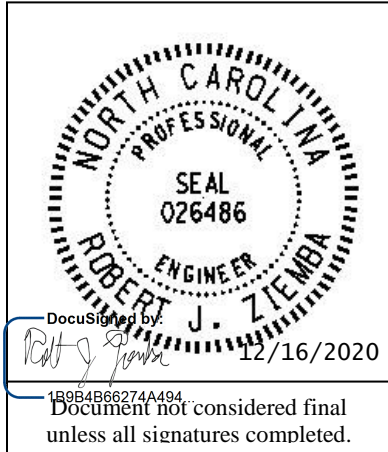

Contents

**1. 2018 STANDARD SPECIFICATIONS FOR ROADS & STRUCTURES.....3**

1.1. GENERAL REQUIREMENTS – CONSTRUCTION METHODS (1700-3(K)) ..... 3

1.2. GENERAL REQUIREMENTS – CONSTRUCTION METHODS (1700-3(M))..... 3

1.3. WOOD POLES – CONSTRUCTION METHODS (1720-3) ..... 3

**2. SIGNAL HEADS.....3**

2.1. MATERIALS ..... 3

A. General:..... 3

B. Vehicle Signal Heads:..... 5

C. Pedestrian Signal Heads: ..... 7

D. Signal Cable: ..... 9

**3. CONTROLLERS WITH CABINETS .....9**

3.1. MATERIALS – GENERAL CABINETS ..... 9

3.2. MATERIALS – TYPE 170E CABINETS ..... 10

A. Type 170 E Cabinets General:..... 10

B. Type 170 E Cabinet Electrical Requirements:..... 10

C. Type 170 E Cabinet Physical Requirements:..... 17

D. Model 2018 Enhanced Conflict Monitor: ..... 18

3.3. MATERIALS – TYPE 170 DETECTOR SENSOR UNITS ..... 28

3.4. MATERIALS – TYPE 2070LX CONTROLLERS ..... 28

**4. PUSH BUTTON INTEGRATED ACCESSIBLE PEDESTRIAN SIGNAL (APS) .....29**

4.1. DESCRIPTION ..... 29

4.2. MATERIALS ..... 29

4.3. CONSTRUCTION METHODS ..... 30

4.4. MEASUREMENT AND PAYMENT ..... 30

**5. VIDEO IMAGING LOOP EMULATOR DETECTOR SYSTEMS .....31**

5.1. DESCRIPTION ..... 31

5.2. MATERIALS ..... 31

A. General:..... 31

B. Loop Emulator System:..... 33

C. Video Imaging Loop Emulator System Support:..... 34

5.3. CONSTRUCTION METHODS ..... 34

5.4. MEASUREMENT AND PAYMENT ..... 35

**6. METAL POLE SUPPORTS .....35**

6.1. METAL POLES ..... 35

A. General:..... 35

B. Materials: ..... 37

C. Design:..... 39

- D. *Strain Poles:* ..... 40
- 6.2. DRILLED PIER FOUNDATIONS FOR METAL POLES..... 41
  - A. *Description:*..... 42
  - B. *Soil Test and Foundation Determination:* ..... 42
  - C. *Drilled Pier Construction:*..... 44
- 6.3. METAL POLE REMOVALS ..... 44
  - A. *Description:*..... 44
  - B. *Construction Methods:* ..... 45
- 6.4. POLE NUMBERING SYSTEM ..... 45
- 6.5. MEASUREMENT AND PAYMENT ..... 45
- 7. JUNCTION BOX MARKERS..... 46**
  - 7.1. DESCRIPTION ..... 46
  - 7.2. MATERIALS ..... 46
    - A. *Junction Box Markers*..... 46
  - 7.3. CONSTRUCTION METHODS ..... 47
  - 7.4. MEASUREMENT AND PAYMENT ..... 47
- 8. BACK PULL FIBER OPTIC CABLE ..... 47**
  - 8.1. DESCRIPTION ..... 47
  - 8.2. CONSTRUCTION ..... 47
  - 8.3. MEASUREMENT AND PAYMENT ..... 48
- 9. ETHERNET EDGE SWITCH..... 48**
  - 9.1. DESCRIPTION ..... 48
    - A. *Ethernet Edge Switch:* ..... 48
    - B. *Network Management:*..... 48
  - 9.2. MATERIALS ..... 48
    - A. *General:*..... 48
    - B. *Compatibility Acceptance*..... 49
    - C. *Standards:*..... 49
    - D. *Functional:* ..... 49
    - E. *Physical Features:* ..... 50
    - F. *Management Capabilities:*..... 51
    - G. *Electrical Specifications:* ..... 52
    - H. *Environmental Specifications:* ..... 52
    - I. *Ethernet Patch Cable:* ..... 52
  - 9.3. CONSTRUCTION METHODS ..... 53
    - A. *General:*..... 53
    - B. *Edge Switch:* ..... 53
  - 9.4. MEASUREMENT AND PAYMENT..... 53
- 10. MODIFY SPREAD SPECTRUM WIRELESS RADIO ..... 54**
  - 10.1. DESCRIPTION ..... 54
  - 10.2. MATERIALS ..... 54
  - 10.3. CONSTRUCTION METHODS ..... 54
  - 10.4. MEASUREMENT AND PAYMENT..... 54
- 11. REMOVE SPREAD SPECTRUM WIRELESS RADIO ..... 55**
  - 11.1. DESCRIPTION ..... 55
  - 11.2. CONSTRUCTION METHODS ..... 55
  - 11.3. MEASUREMENT AND PAYMENT..... 55
- 12. GPS EMERGENCY VEHICLE PREEMPTION SYSTEM RELOCATION ..... 55**
  - 12.1. DESCRIPTION ..... 55
  - 12.2. MATERIALS ..... 55
  - 12.3. CONSTRUCTION METHODS ..... 55
  - 12.4. MEASUREMENT AND PAYMENT..... 55

## 1. 2018 STANDARD SPECIFICATIONS FOR ROADS & STRUCTURES

*The 2018 Standard Specifications are revised as follows:*

### 1.1. GENERAL REQUIREMENTS – Construction Methods (1700-3(K))

Page 17-4, revise sentence starting on line 14 to read “Modify existing electrical services, as necessary, to meet the grounding requirements of the NEC, these *Standard Specifications*, *Standard Drawings*, and the project plans.”

Page 17-4, revise sentence beginning on line 21 to read “Furnish and install additional ground rods to grounding electrode system as necessary to meet the *Standard Specifications*, *Standard Drawings*, and test requirements.”

### 1.2. GENERAL REQUIREMENTS – Construction Methods (1700-3(M))

Page 17-4, Replace the sentence beginning on line 41 with “Prior to placing signal in the steady (stop-and-go) mode, the signal should be placed in the flashing mode for up to 7 days or as directed by the Engineer. The signal should not be placed in the steady (stop-and-go) mode on a Saturday or Sunday without prior approval from the Engineer. Do not place the signal in steady (stop-and-go) mode until inspected and without the prior approval of the Engineer.”

### 1.3. WOOD POLES – Construction Methods (1720-3)

Page 17-18, revise sentence starting on line 13 to read “On new Department-owned poles, install a grounding system consisting of #6 AWG solid bare copper wire that is mechanically crimped using an irreversible compression tool with die to a single ground rod installed at base of pole or to the electrical service grounding electrode system located within 10 feet of the pole.”

## 2. SIGNAL HEADS

### 2.1. MATERIALS

#### A. General:

Fabricate vehicle signal head housings and end caps from die-cast aluminum. Fabricate 16-inch pedestrian signal head housings and end caps from die-cast aluminum. Provide visor mounting screws, door latches, and hinge pins fabricated from stainless steel. Provide interior screws, fasteners, and metal parts fabricated from stainless steel.

Fabricate tunnel and traditional visors from sheet aluminum.

Paint all surfaces inside and outside of signal housings and doors. Paint outside surfaces of tunnel and traditional visors, wire outlet bodies, wire entrance fitting brackets and end caps when supplied as components of messenger cable mounting assemblies, pole and pedestal mounting assemblies, and pedestrian pushbutton housings. Have electrostatically-applied, fused-polyester paint in highway yellow (Federal Standard 595C, Color Chip Number 13538) a minimum of 2.5 to 3.5 mils thick. Do not apply paint to the latching hardware, rigid vehicle signal head mounting brackets for mast-arm attachments, messenger cable hanger components or balance adjuster components.

Have the interior surfaces of tunnel and traditional visors painted an alkyd urea black synthetic baking enamel with a minimum gloss reflectance and meeting the requirements of MIL-E-10169, “Enamel Heat Resisting, Instrument Black.”

Where required, provide polycarbonate signal heads and visors that comply with the provisions pertaining to the aluminum signal heads listed on the QPL with the following exceptions:

Fabricate signal head housings, end caps, and visors from virgin polycarbonate material. Provide UV stabilized polycarbonate plastic with a minimum thickness of  $0.1 \pm 0.01$  inches that is highway yellow (Federal Standard 595C, Color Chip 13538). Ensure the color is incorporated into the plastic material before molding the signal head housings and end caps. Ensure the plastic formulation provides the following physical properties in the assembly (tests may be performed on separately molded specimens):

Test	Required	Method
Specific Gravity	1.17 minimum	ASTM D 792
Flammability	Self-extinguishing	ASTM D 635
Tensile Strength, yield, PSI	8500 minimum	ASTM D 638
Izod impact strength, ft-lb/in [notched, 1/8 inch]	12 minimum	ASTM D 256

For pole mounting, provide side of pole mounting assemblies with framework and all other hardware necessary to make complete, watertight connections of the signal heads to the poles and pedestals. Fabricate the mounting assemblies and frames from aluminum with all necessary hardware, screws, washers, etc. to be stainless steel. Provide mounting fittings that match the positive locking device on the signal head with the serrations integrally cast into the brackets. Provide upper and lower pole plates that have a 1 ¼-inch vertical conduit entrance hubs with the hubs capped on the lower plate and 1 ½-inch horizontal hubs. Ensure that the assemblies provide rigid attachments to poles and pedestals so as to allow no twisting or swaying of the signal heads. Ensure that all raceways are free of sharp edges and protrusions, and can accommodate a minimum of ten Number 14 AWG conductors.

For pedestal mounting, provide a post-top slipfitter mounting assembly that matches the positive locking device on the signal head with serrations integrally cast into the slipfitter. Provide stainless steel hardware, screws, washers, etc. Provide a minimum of six 3/8 X 3/4-inch long square head bolts for attachment to pedestal. Provide a center post for multi-way slipfitters.

For light emitting diode (LED) traffic signal modules, provide the following requirements for inclusion on the Department's Qualified Products List for traffic signal equipment.

1. Sample submittal,
2. Third-party independent laboratory testing results for each submitted module with evidence of testing and conformance with all of the Design Qualification Testing specified in section 6.4 of each of the following Institute of Transportation Engineers (ITE) specifications:
  - Vehicle Traffic Control Signal Heads – Light Emitting Diode (LED) Circular Signal Supplement
  - Vehicle Traffic Control Signal Heads – Light Emitting Diode (LED) Vehicle Arrow Traffic Signal Supplement
  - Pedestrian Traffic Control Signal Indications –Light Emitting Diode (LED) Signal Modules.

(Note: The Department currently recognizes two approved independent testing laboratories. They are Intertek ETL Semko and Light Metrics, Incorporated with Garwood Laboratories.

Independent laboratory tests from other laboratories may be considered as part of the QPL submittal at the discretion of the Department,

3. Evidence of conformance with the requirements of these specifications,
4. A manufacturer's warranty statement in accordance with the required warranty, and
5. Submittal of manufacturer's design and production documentation for the model, including but not limited to, electrical schematics, electronic component values, proprietary part numbers, bill of materials, and production electrical and photometric test parameters.
6. Evidence of approval of the product to bear the Intertek ETL Verified product label for LED traffic signal modules.

In addition to meeting the performance requirements for the minimum period of 60 months, provide a written warranty against defects in materials and workmanship for the modules for a period of 60 months after installation of the modules. During the warranty period, the manufacturer must provide new replacement modules within 45 days of receipt of modules that have failed at no cost to the State. Repaired or refurbished modules may not be used to fulfill the manufacturer's warranty obligations. Provide manufacturer's warranty documentation to the Department during evaluation of product for inclusion on Qualified Products List (QPL).

#### **B. Vehicle Signal Heads:**

Comply with the ITE standard "Vehicle Traffic Control Signal Heads". Provide housings with provisions for attaching backplates.

Provide visors that are 10 inches in length for 12-inch vehicle signal heads.

Provide a termination block with one empty terminal for field wiring for each indication plus one empty terminal for the neutral conductor. Have all signal sections wired to the termination block. Provide barriers between the terminals that have terminal screws with a minimum Number 8 thread size and that will accommodate and secure spade lugs sized for a Number 10 terminal screw.

Mount termination blocks in the yellow signal head sections on all in-line vehicle signal heads. Mount the termination block in the red section on five-section vehicle signal heads.

Furnish vehicle signal head interconnecting brackets. Provide one-piece aluminum brackets less than 4.5 inches in height and with no threaded pipe connections. Provide hand holes on the bottom of the brackets to aid in installing wires to the signal heads. Lower brackets that carry no wires and are used only for connecting the bottom signal sections together may be flat in construction.

For messenger cable mounting, provide messenger cable hangers, wire outlet bodies, balance adjusters, bottom caps, wire entrance fitting brackets, and all other hardware necessary to make complete, watertight connections of the vehicle signal heads to the messenger cable. Fabricate messenger cable hanger components, wire outlet bodies and balance adjuster components from stainless steel or malleable iron galvanized in accordance with ASTM A153 (Class A) or ASTM A123. Provide serrated rings made of aluminum. Provide messenger cable hangers with U-bolt clamps. Fabricate washers, screws, hex-head bolts and associated nuts, clevis pins, cotter pins, U-bolt clamps and nuts from stainless steel.

Provide LED vehicular traffic signal modules (hereafter referred to as modules) that consist of an assembly that uses LEDs as the light source in lieu of an incandescent lamp for use in traffic signal sections. Use LEDs that are aluminum indium gallium phosphorus (AlInGaP) technology for red and



yellow indications and indium gallium nitride (InGaN) for green indications. Install the ultra bright type LEDs that are rated for 100,000 hours of continuous operation from -40°F to +165°F. Design modules to have a minimum useful life of 60 months and to meet all parameters of this specification during this period of useful life.

For the modules, provide spade terminals crimped to the lead wires and sized for a #10 screw connection to the existing terminal block in a standard signal head. Do not provide other types of crimped terminals with a spade adapter.

Ensure the power supply is integral to the module assembly. On the back of the module, permanently mark the date of manufacture (month & year) or some other method of identifying date of manufacture.

Tint the red, yellow and green lenses to correspond with the wavelength (chromaticity) of the LED. Transparent tinting films are unacceptable. Provide a lens that is integral to the unit with a smooth outer surface.

### 1. LED Circular Signal Modules:

Provide modules in the following configurations: 12-inch circular sections. All makes and models of LED modules purchased for use on the State Highway System shall appear on the current NCDOT Traffic Signal Qualified Products List (QPL).

Provide the manufacturer's model number and the product number (assigned by the Department) for each module that appears on the 2018 or most recent Qualified Products List. In addition, provide manufacturer's certification in accordance with Article 106-3 of the *Standard Specifications*, that each module meets or exceeds the ITE "Vehicle Traffic Control Signal Heads – Light Emitting Diode (LED) Circular Signal Supplement" dated June 27, 2005 (hereafter referred to as VTCSH Circular Supplement) and other requirements stated in this specification.

Provide modules that meet the following requirements when tested under the procedures outlined in the VTCSH Circular Supplement:

Module Type	Max. Wattage at 165° F	Nominal Wattage at 77° F
12-inch red circular	17	11
12-inch green circular	15	15

For yellow circular signal modules, provide modules tested under the procedures outlined in the VTCSH Circular Supplement to insure power required at 77° F is 22 Watts or less for the 12-inch circular module.

Note: Use a wattmeter having an accuracy of  $\pm 1\%$  to measure the nominal wattage and maximum wattage of a circular traffic signal module. Power may also be derived from voltage, current and power factor measurements.

### 2. LED Arrow Signal Modules

Provide 12-inch omnidirectional arrow signal modules. All makes and models of LED modules purchased for use on the State Highway System shall appear on the current NCDOT Traffic Signal Qualified Products List (QPL).

Provide the manufacturer's model number and the product number (assigned by the Department) for each module that appears on the 2018 or most recent Qualified Products List. In addition, provide

manufacturer's certification in accordance with Article 106-3 of the *Standard Specifications*, that each module meets or exceeds the requirements for 12-inch omnidirectional modules specified in the ITE "Vehicle Traffic Control Signal Heads – Light Emitting Diode (LED) Vehicle Arrow Traffic Signal Supplement" dated July 1, 2007 (hereafter referred to as VTCSH Arrow Supplement) and other requirements stated in this specification.

Provide modules that meet the following requirements when tested under the procedures outlined in the VTCSH Arrow Supplement:

Module Type	Max. Wattage at 165° F	Nominal Wattage at 77° F
12-inch red arrow	12	9
12-inch green arrow	11	11

For yellow arrow signal modules, provide modules tested under the procedures outlined in the VTCSH Arrow Supplement to insure power required at 77° F is 12 Watts or less.

Note: Use a wattmeter having an accuracy of  $\pm 1\%$  to measure the nominal wattage and maximum wattage of an arrow traffic signal module. Power may also be derived from voltage, current and power factor measurements.

### C. Pedestrian Signal Heads:

Provide pedestrian signal heads with international symbols that meet the MUTCD. Do not provide letter indications.

Comply with the ITE standard for "Pedestrian Traffic Control Signal Indications" and the following sections of the ITE standard for "Vehicle Traffic Control Signal Heads" in effect on the date of advertisement:

- Section 3.00 - "Physical and Mechanical Requirements"
- Section 4.01 - "Housing, Door, and Visor: General"
- Section 4.04 - "Housing, Door, and Visor: Materials and Fabrication"
- Section 7.00 - "Exterior Finish"

Provide a double-row termination block with three empty terminals and number 10 screws for field wiring. Provide barriers between the terminals that accommodate a spade lug sized for number 10 terminal screws. Mount the termination block in the hand section. Wire all signal sections to the terminal block.

Where required by the plans, provide 16-inch pedestrian signal heads with traditional three-sided, rectangular visors, 6 inches long.

Provide 2-inch diameter pedestrian push-buttons with weather-tight housings fabricated from die-cast aluminum and threading in compliance with the NEC for rigid metal conduit. Provide a weep hole in the housing bottom and ensure that the unit is vandal resistant.

Provide push-button housings that are suitable for mounting on flat or curved surfaces and that will accept 1/2-inch conduit installed in the top. Provide units that have a heavy duty push-button assembly with a sturdy, momentary, normally-open switch. Have contacts that are electrically insulated from the housing and push-button. Ensure that the push-buttons are rated for a minimum of 5 mA at 24 volts DC and 250 mA at 12 volts AC.

Provide standard R10-3 signs with mounting hardware that comply with the MUTCD in effect on the date of advertisement. Provide R10-3E signs for countdown pedestrian heads and R10-3B for non-countdown pedestrian heads.

Design the LED pedestrian traffic signal modules (hereafter referred to as modules) for installation into standard pedestrian traffic signal sections that do not contain the incandescent signal section reflector, lens, eggcrate visor, gasket, or socket. Provide modules that consist of an assembly that uses LEDs as the light source in lieu of an incandescent lamp. Use LEDs that are of the latest aluminum indium gallium phosphorus (AlInGaP) technology for the Portland Orange hand and countdown displays. Use LEDs that are of the latest indium gallium nitride (InGaN) technology for the Lunar White walking man displays. Install the ultra-bright type LEDs that are rated for 100,000 hours of continuous operation from -40°F to +165°F. Design modules to have a minimum useful life of 60 months and to meet all parameters of this specification during this period of useful life.

Design all modules to operate using a standard 3 - wire field installation. Provide spade terminals crimped to the lead wires and sized for a #10 screw connection to the existing terminal block in a standard pedestrian signal housing. Do not provide other types of crimped terminals with a spade adapter.

Ensure the power supply is integral to the module assembly. On the back of the module, permanently mark the date of manufacture (month & year) or some other method of identifying date of manufacture.

Provide modules in the following configuration: 16-inch displays which have the solid hand/walking man overlay on the left and the countdown on the right. All makes and models of LED modules purchased for use on the State Highway System shall appear on the current NCDOT Traffic Signal Qualified Products List (QPL).

Provide the manufacturer's model number and the product number (assigned by the Department) for each module that appears on the 2018 or most recent Qualified Products List. In addition, provide manufacturer's certification in accordance with Article 106-3 of the *Standard Specifications*, that each module meets or exceeds the ITE "Pedestrian Traffic Control Signal Indicators - Light Emitting Diode (LED) Signal Modules" dated August 04, 2010 (hereafter referred to as PTCSI Pedestrian Standard) and other requirements stated in this specification.

Provide modules that meet the following requirements when tested under the procedures outlined in the PTCSI Pedestrian Standard:

Module Type	Max. Wattage at 165° F	Nominal Wattage at 77° F
Hand Indication	16	13
Walking Man Indication	12	9
Countdown Indication	16	13

Note: Use a wattmeter having an accuracy of  $\pm 1\%$  to measure the nominal wattage and maximum wattage of a circular traffic signal module. Power may also be derived from voltage, current and power factor measurements.

Provide module lens that is hard coated or otherwise made to comply with the material exposure and weathering effects requirements of the Society of Automotive Engineers (SAE) J576. Ensure all exposed components of the module are suitable for prolonged exposure to the environment, without appreciable degradation that would interfere with function or appearance.

Ensure the countdown display continuously monitors the traffic controller to automatically learn the pedestrian phase time and update for subsequent changes to the pedestrian phase time.

Ensure the countdown display begins normal operation upon the completion of the preemption sequence and no more than one pedestrian clearance cycle.

#### **D. Signal Cable:**

Furnish 16-4 and 16-7 signal cable that complies with IMSA specification 20-1 except provide the following conductor insulation colors:

- For 16-4 cable: white, yellow, red, and green
- For 16-7 cable: white, yellow, red, green, yellow with black stripe tracer, red with black stripe tracer, and green with black stripe tracer. Apply continuous stripe tracer on conductor insulation with a longitudinal or spiral pattern.

Provide a ripcord to allow the cable jacket to be opened without using a cutter. IMSA specification 19-1 will not be acceptable. Provide a cable jacket labeled with the IMSA specification number and provide conductors constructed of stranded copper.

### **3. CONTROLLERS WITH CABINETS**

#### **3.1. MATERIALS – GENERAL CABINETS**

Provide a moisture resistant coating on all circuit boards.

Provide one 20 mm diameter radial lead UL-recognized metal oxide varistor (MOV) between each load switch field terminal and equipment ground. Electrical performance is outlined below.

<b>PROPERTIES OF MOV SURGE PROTECTOR</b>	
Maximum Continuous Applied Voltage at 185° F	150 VAC (RMS) 200 VDC
Maximum Peak 8x20µs Current at 185° F	6500 A
Maximum Energy Rating at 185° F	80 J
Voltage Range 1 mA DC Test at 77° F	212-268 V
Max. Clamping Voltage 8x20µs, 100A at 77° F	395 V
Typical Capacitance (1 MHz) at 77° F	1600 pF

Provide a power line surge protector that is a two-stage device that will allow connection of the radio frequency interference filter between the stages of the device. Ensure that a maximum continuous current is at least 10A at 120V. Ensure that the device can withstand a minimum of 20 peak surge current occurrences at 20,000A for an 8x20 microsecond waveform. Provide a maximum clamp voltage of 395V at 20,000A with a nominal series inductance of 200µh. Ensure that the voltage does not exceed 395V. Provide devices that comply with the following:

Frequency (Hz)	Minimum Insertion Loss (dB)
60	0
10,000	30
50,000	55
100,000	50
500,000	50
2,000,000	60
5,000,000	40
10,000,000	20
20,000,000	25

### 3.2. MATERIALS – TYPE 170E CABINETS

#### A. Type 170 E Cabinets General:

Conform to the city of Los Angeles' Specification No. 54-053-08, *Traffic Signal Cabinet Assembly Specification* (dated July 2008), except as required herein.

Furnish model 332 base mounted cabinets configured for 8 vehicle phases, 4 pedestrian phases, and 6 overlaps. When overlaps are required, provide auxiliary output files for the overlaps. Do not reassign load switches to accommodate overlaps unless shown on electrical details.

Provide model 200 load switches, model 222 loop detector sensors, model 252 AC isolators, and model 242 DC isolators according to the electrical details. As a minimum, provide one (1) model 2018 conflict monitor, one (1) model 206L power supply unit, two (2) model 204 flashers, one (1) DC isolator (located in slot I14), and four (4) model 430 flash transfer relays (provide seven (7) model 430 flash transfer relays if auxiliary output file is installed) with each cabinet.

#### B. Type 170 E Cabinet Electrical Requirements:

Provide a cabinet assembly designed to ensure that upon leaving any cabinet switch or conflict monitor initiated flashing operation, the controller starts up in the programmed start up phases and start up interval.

Furnish two sets of non-fading cabinet wiring diagrams and schematics in a paper envelope or container and placed in the cabinet drawer.

All AC+ power is subject to radio frequency signal suppression.

Provide surge suppression in the cabinet for each type of cabinet device. Provide surge protection for the full capacity of the cabinet input file. Provide surge suppression devices that operate properly over a temperature range of -40° F to +185° F. Ensure the surge suppression devices provide both common and differential modes of protection.

Provide a pluggable power line surge protector that is installed on the back of the PDA (power distribution assembly) chassis to filter and absorb power line noise and switching transients. Ensure

the device incorporates LEDs for failure indication and provides a dry relay contact closure for the purpose of remote sensing. Ensure the device meets the following specifications:

- Peak Surge Current (Single pulse, 8x20µs).....20,000A
- Occurrences (8x20µs waveform).....10 minimum @ 20,000A
- Maximum Clamp Voltage.....395VAC
- Operating Current.....15 amps
- Response Time.....< 5 nanoseconds

Provide a loop surge suppressor for each set of loop terminals in the cabinet. Ensure the device meets the following specifications:

- Peak Surge Current (6 times, 8x20µs)
  - (Differential Mode).....400A
  - (Common Mode).....1,000A
- Occurrences (8x20µs waveform).....500 min @ 200A
- Maximum Clamp Voltage
  - (Differential Mode @400A).....35V
  - (Common Mode @1,000A).....35V
- Response Time.....< 5 nanoseconds
- Maximum Capacitance.....35 pF

Provide a data communications surge suppressor for each communications line entering or leaving the cabinet. Ensure the device meets the following specifications:

- Peak Surge Current (Single pulse, 8x20µs).....10,000A
- Occurrences (8x20µs waveform).....100 min @ 2,000A
- Maximum Clamp Voltage.....Rated for equipment protected
- Response Time.....< 1 nanosecond
- Maximum Capacitance.....1,500 pF
- Maximum Series Resistance.....15Ω

Provide a DC signal surge suppressor for each DC input channel in the cabinet. Ensure the device meets the following specifications:

- Peak Surge Current (Single pulse, 8x20µs).....10,000A
- Occurrences (8x20µs waveform).....100 @ 2,000A
- Maximum Clamp Voltage.....30V
- Response Time.....< 1 nanosecond

Provide a 120 VAC signal surge suppressor for each AC+ interconnect signal input. Ensure the device meets the following specifications:

- Peak Surge Current (Single pulse, 8x20µs).....20,000A
- Maximum Clamp Voltage.....350VAC
- Response Time.....< 200 nanoseconds
- Discharge Voltage.....<200 Volts @ 1,000A
- Insulation Resistance.....≥100 MΩ

Provide conductors for surge protection wiring that are of sufficient size (ampacity) to withstand maximum overcurrents which could occur before protective device thresholds are attained and current flow is interrupted.

If additional surge protected power outlets are needed to accommodate fiber transceivers, modems, etc., install a UL listed, industrial, heavy-duty type power outlet strip with a minimum rating of 15 A / 125 VAC, 60 Hz. Provide a strip that has a minimum of 3 grounded outlets. Ensure the power outlet strip plugs into one of the controller unit receptacles located on the rear of the PDA. Ensure power outlet strip is mounted securely; provide strain relief if necessary.

Provide a door switch in the front and a door switch in the rear of the cabinet that will provide the controller unit with a Door Ajar alarm when either the front or the rear door is open. Ensure the door switches apply DC ground to the Input File when either the front door or the rear door is open.

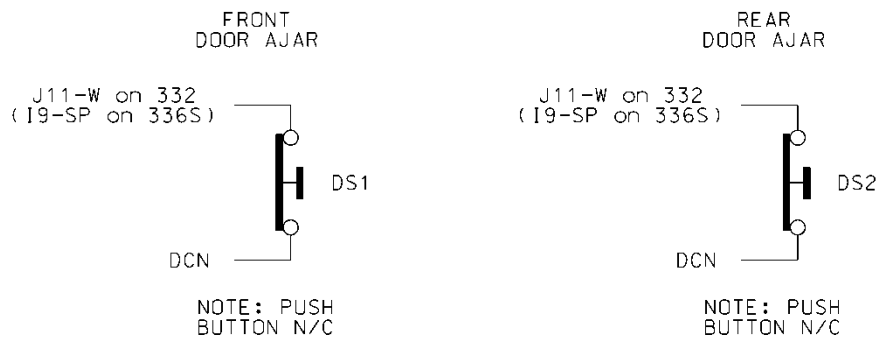

Furnish a fluorescent fixture in the rear across the top of the cabinet and another fluorescent fixture in the front across the top of the cabinet at a minimum. Ensure that the fixtures provide sufficient light to illuminate all terminals, labels, switches, and devices in the cabinet. Conveniently locate the fixtures so as not to interfere with a technician’s ability to perform work on any devices or terminals in the cabinet. Provide a protective diffuser to cover exposed bulbs. Install 16 watt T-4 lamps in the fluorescent fixtures. Provide a door switch to provide power to each fixture when the respective door is open. Wire the fluorescent fixtures to the 15 amp ECB (equipment circuit breaker).

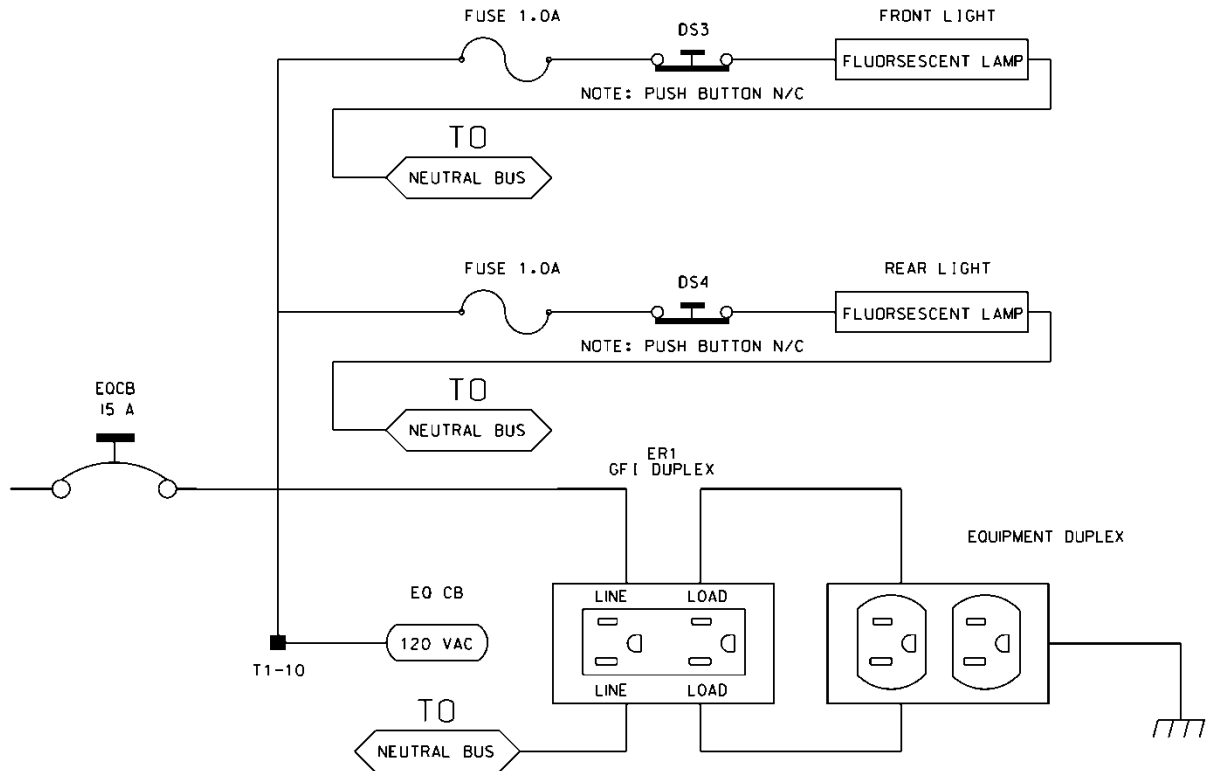

Furnish a police panel with a police panel door. Ensure that the police panel door permits access to the police panel when the main door is closed. Ensure that no rainwater can enter the cabinet even with the police panel door open. Provide a police panel door hinged on the right side as viewed from the front. Provide a police panel door lock that is keyed to a standard police/fire call box key. In addition to the requirements of LA Specification No. 54-053-08, provide the police panel with a toggle switch connected to switch the intersection operation between normal stop-and-go operation (AUTO) and manual operation (MANUAL). Ensure that manual control can be implemented using inputs and software such that the controller provides full programmed clearance times for the yellow clearance and red clearance for each phase while under manual control.

Provide a 1/4-inch locking phone jack in the police panel for a hand control to manually control the intersection. Provide sufficient room in the police panel for storage of a hand control and cord.

For model 332 base mounted cabinets, ensure terminals J14-E and J14-K are wired together on the rear of the Input File. Connect TB9-12 (J14 Common) on the Input Panel to T1-2 (AC-) on the rear of the PDA.

Provide detector test switches mounted at the top of the cabinet rack or other convenient location which may be used to place a call on each of eight phases based on the chart below. Provide three positions for each switch: On (place call), Off (normal detector operation), and Momentary On (place momentary call and return to normal detector operation after switch is released). Ensure that the switches are located such that the technician can read the controller display and observe the intersection.

Connect detector test switches for cabinets as follows:



332 Cabinet	
Detector Call Switches	Terminals
Phase 1	I1-W
Phase 2	I4-W
Phase 3	I5-W
Phase 4	I8-W
Phase 5	J1-W
Phase 6	J4-W
Phase 7	J5-W
Phase 8	J8-W

Provide the PCB 28/56 connector for the conflict monitor unit (CMU) with 28 independent contacts per side, dual-sided with 0.156 inch contact centers. Provide the PCB 28/56 connector contacts with solder eyelet terminations. Ensure all connections to the PCB 28/56 connector are soldered to the solder eyelet terminations.

Ensure that all cabinets have the CMU connector wired according to the 332 cabinet connector pin assignments (include all wires for auxiliary output file connection). Wire pins 13, 16, R, and U of the CMU connector to a separate 4 pin plug, P1, as shown below. Provide a second plug, P2, which will mate with P1 and is wired to the auxiliary output file as shown below. Provide an additional plug, P3, which will mate with P1 and is wired to the pedestrian yellow circuits as shown below. When no auxiliary output file is installed in the cabinet, provide wires for the green and yellow inputs for channels 11, 12, 17, and 18, the red inputs for channels 17 and 18, and the wires for the P2 plug. Terminate the two-foot wires with ring type lugs, insulated, and bundled for optional use.

PIN	P1		P2		P3	
	FUNCTION	CONN TO	FUNCTION	CONN TO	FUNCTION	CONN TO
1	CH-9G	CMU-13	OLA-GRN	A123	2P-YEL	114
2	CH-9Y	CMU-16	OLA-YEL	A122	4P-YEL	105
3	CH-10G	CMU-R	OLB-GRN	A126	6P-YEL	120
4	CH-10Y	CMU-U	OLB-YEL	A125	8P-YEL	111

Do not provide the P20 terminal assembly (red monitor board) or red interface ribbon cable as specified in LA Specification No. 54-053-08.

Provide a P20 connector that mates with and is compatible with the red interface connector mounted on the front of the conflict monitor. Ensure that the P20 connector and the red interface connector on the conflict monitor are center polarized to ensure proper connection. Ensure that

removal of the P20 connector will cause the conflict monitor to recognize a latching fault condition and place the cabinet into flashing operation.

Wire the P20 connector to the output file and auxiliary output file using 22 AWG stranded wires. Ensure the length of these wires is a minimum of 42 inches in length. Provide a durable braided sleeve around the wires to organize and protect the wires.

Wire the P20 connector to the traffic signal red displays to provide inputs to the conflict monitor as shown below. Ensure the pedestrian Don't Walk circuits are wired to channels 13 through 16 of the P20 connector. When no auxiliary output file is installed in the cabinet, provide wires for channels 9 through 12 reds. Provide a wire for special function 1. Terminate the unused wires with ring type lugs, insulated, and bundled for optional use.

P20 Connector					
PIN	FUNCTION	CONN TO	PIN	FUNCTION	CONN TO
1	Channel 15 Red	119	2	Channel 16 Red	110
3	Channel 14 Red	104	4	Chassis GND	01-9
5	Channel 13 Red	113	6	N/C	
7	Channel 12 Red	AUX 101	8	Spec Function 1	
9	Channel 10 Red	AUX 124	10	Channel 11 Red	AUX 114
11	Channel 9 Red	AUX 121	12	Channel 8 Red	107
13	Channel 7 Red	122	14	Channel 6 Red	134
15	Channel 5 Red	131	16	Channel 4 Red	101
17	Channel 3 Red	116	18	Channel 2 Red	128
19	Channel 1 Red	125	20	Red Enable	01-14

Ensure the controller unit outputs to the auxiliary output file are pre-wired to the C5 connector. When no auxiliary output file is installed in the cabinet, connect the C5 connector to a storage socket located on the Input Panel or on the rear of the PDA.

Do not wire pin 12 of the load switch sockets.

In addition to the requirements of LA Specification No. 54-053-08, ensure relay K1 on the Power Distribution Assembly (PDA) is a four pole relay and K2 on the PDA is a two pole relay.

Provide a two pole, ganged circuit breaker for the flash bus circuit. Ensure the flash bus circuit breaker is an inverse time circuit breaker rated for 10 amps at 120 VAC with a minimum of 10,000 RMS symmetrical amperes short circuit current rating. Do not provide the auxiliary switch feature on the flash bus circuit breaker. Ensure the ganged flash bus circuit breaker is certified by the circuit breaker manufacturer to provide gang tripping operation.

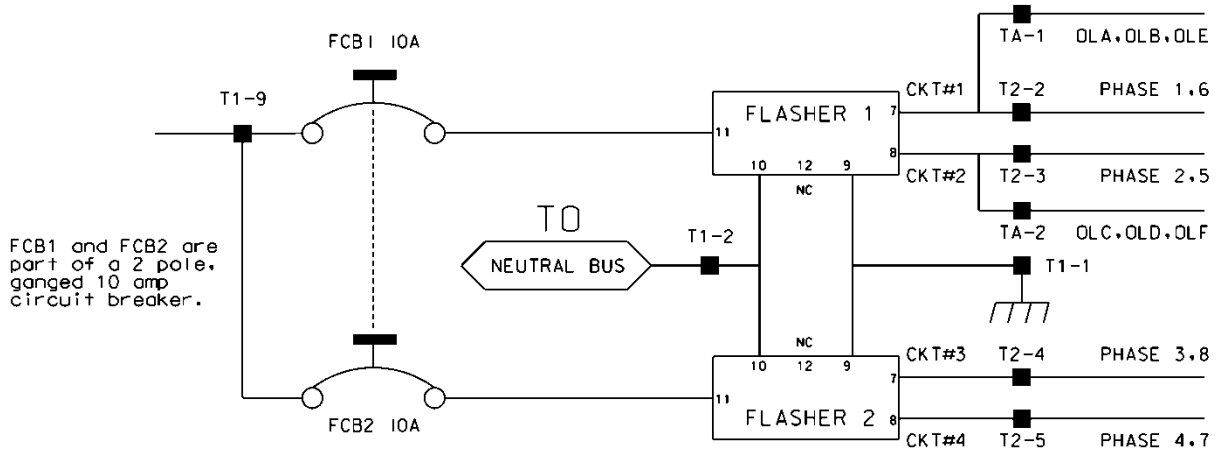

Ensure auxiliary output files are wired as follows:

AUXILIARY OUTPUT FILE	
TERMINAL BLOCK TA ASSIGNMENTS	
POSITION	FUNCTION
1	Flasher Unit #1, Circuit 1/FTR1 (OLA, OLB)/FTR3 (OLE)
2	Flasher Unit #1, Circuit 2/FTR2 (OLC, OLD)/FTR3 (OLF)
3	Flash Transfer Relay Coils
4	AC -
5	Power Circuit 5
6	Power Circuit 5
7	Equipment Ground Bus
8	NC

Provide four spare load resistors mounted in each cabinet. Ensure each load resistor is rated as shown in the table below. Wire one side of each load resistor to AC-. Connect the other side of each resistor to a separate terminal on a four (4) position terminal block. Mount the load resistors and terminal block either inside the back of Output File No. 1 or on the upper area of the Service Panel.

ACCEPTABLE LOAD RESISTOR VALUES	
VALUE (ohms)	WATTAGE
1.5K – 1.9 K	25W (min)
2.0K – 3.0K	10W (min)

Provide Model 200 load switches, Model 204 flashers, Model 242 DC isolators, Model 252 AC isolators, and Model 206L power supply units that conform to CALTRANS' *"Transportation Electrical Equipment Specifications"* dated March 12, 2009 with Erratum 1.

### **C. Type 170 E Cabinet Physical Requirements:**

Do not mold, cast, or scribe the name "City of Los Angeles" on the outside of the cabinet door as specified in LA Specification No. 54-053-08. Do not provide a Communications Terminal Panel as specified in LA Specification No. 54-053-08. Do not provide terminal block TBB on the Service Panel. Do not provide Cabinet Verification Test Program software or associated test jigs as specified in LA Specification No. 54-053-08.

Furnish unpainted, natural, aluminum cabinet shells. Ensure that all non-aluminum hardware on the cabinet is stainless steel or a Department approved non-corrosive alternate.

Ensure the lifting eyes, gasket channels, police panel, and all supports welded to the enclosure and doors are fabricated from 0.125 inch minimum thickness aluminum sheet and meet the same standards as the cabinet and doors.

Provide front and rear doors with latching handles that allow padlocking in the closed position. Furnish 0.75 inch minimum diameter stainless steel handles with a minimum 0.5 inch shank. Place the padlocking attachment at 4.0 inches from the handle shank center to clear the lock and key. Provide an additional 4.0 inches minimum gripping length.

Provide Corbin #2 locks on the front and rear doors. Provide one (1) Corbin #2 and one (1) police master key with each cabinet. Ensure main door locks allow removal of keys in the locked position only.

Provide a surge protection panel with 16 loop surge protection devices and designed to allow sufficient free space for wire connection/disconnection and surge protection device replacement. For model 332 cabinets, provide an additional 20 loop surge protection devices. Provide an additional two AC+ interconnect surge devices to protect one slot and eight DC surge protection devices to protect four slots. Provide no protection devices on slot I14.

For base mounted cabinets, mount surge protection panels on the left side of the cabinet as viewed from the rear. Attach each panel to the cabinet rack assembly using bolts and make it easily removable. Mount the surge protection devices in vertical rows on each panel and connect the devices to one side of 12 position, double row terminal blocks with #8 screws. For each surge protection panel, terminate all grounds from the surge protection devices on a copper equipment ground bus attached to the surge protection panel. Wire the terminals to the rear of a standard input file using spade lugs for input file protection.

Provide permanent labels that indicate the slot and the pins connected to each terminal that may be viewed from the rear cabinet door. Label and orient terminals so that each pair of inputs is next to each other. Indicate on the labeling the input file (I or J), the slot number (1-14) and the terminal pins of the input slots (either D & E for upper or J & K for lower).

Provide a minimum 14 x 16 inch pull out, hinged top shelf located immediately below controller mounting section of the cabinet. Ensure the shelf is designed to fully expose the table surface outside the controller at a height approximately even with the bottom of the controller. Ensure the shelf has a storage bin interior which is a minimum of 1 inch deep and approximately the same dimensions as the shelf. Provide an access to the storage area by lifting the hinged top of the shelf. Fabricate the shelf and slide from aluminum or stainless steel and ensure the assembly can support the 2070L

controller plus 15 pounds of additional weight. Ensure shelf has a locking mechanism to secure it in the fully extended position and does not inhibit the removal of the 2070L controller or removal of cards inside the controller when fully extended. Provide a locking mechanism that is easily released when the shelf is to be returned to its non-use position directly under the controller.

**D. Model 2018 Enhanced Conflict Monitor:**

Furnish Model 2018 Enhanced Conflict Monitors that provide monitoring of 18 channels. Ensure each channel consists of a green, yellow, and red field signal input. Ensure that the conflict monitor meets or exceeds CALTRANS' Transportation Electrical Equipment Specifications dated March 12, 2009, with Erratum 1 (hereafter referred to as CALTRANS' 2009 TEES) for a model 210 monitor unit and other requirements stated in this specification.

Ensure the conflict monitor is provided with an 18 channel conflict programming card. Pin EE and Pin T of the conflict programming card shall be connected together. Pin 16 of the conflict programming card shall be floating. Ensure that the absence of the conflict programming card will cause the conflict monitor to trigger (enter into fault mode), and remain in the triggered state until the programming card is properly inserted and the conflict monitor is reset.

Provide a conflict monitor that incorporates LED indicators into the front panel to dynamically display the status of the monitor under normal conditions and to provide a comprehensive review of field inputs with monitor status under fault conditions. Ensure that the monitor indicates the channels that were active during a conflict condition and the channels that experienced a failure for all other per channel fault conditions detected. Ensure that these indications and the status of each channel are retained until the Conflict Monitor is reset. Furnish LED indicators for the following:

- AC Power (Green LED indicator)
- VDC Failed (Red LED indicator)
- WDT Error (Red LED indicator)
- Conflict (Red LED indicator)
- Red Fail (Red LED indicator)
- Dual Indication (Red LED indicator)
- Yellow/Clearance Failure (Red LED indicator)
- PCA/PC Ajar (Red LED indicator)
- Monitor Fail/Diagnostic Failure (Red LED indicator)
- 54 Channel Status Indicators (1 Red, 1 Yellow, and 1 Green LED indicator for each of the 18 channels)

Provide a switch to set the Red Fail fault timing. Ensure that when the switch is in the ON position the Red Fail fault timing value is set to 1350 +/- 150 ms (2018 mode). Ensure that when the switch is in the OFF position the Red Fail fault timing value is set to 850 +/- 150 ms (210 mode).

Provide a switch to set the Watchdog fault timing. Ensure that when the switch is in the ON position the Watchdog fault timing value is set to 1.0 +/- 0.1 s (2018 mode). Ensure that when the switch is in the OFF position the Watchdog fault timing value is set to 1.5 +/- 0.1 s (210 mode).

Provide a jumper or switch to set the AC line brown-out levels. Ensure that when the jumper is present or the switch is in the ON position the AC line dropout voltage threshold is 98 +/- 2 Vrms,

the AC line restore voltage threshold is 103 +/- 2 Vrms, and the AC line brown-out timing value is set to 400 +/- 50ms (2018 mode). Ensure that when the jumper is not present or the switch is in the OFF position the AC line dropout voltage threshold is 92 +/- 2 Vrms, the AC line restore voltage threshold is 98 +/- 2 Vrms, and the AC line brown-out timing value is set to 80 +/- 17 ms (210 mode).

Provide a jumper or switch that will enable and disable the Watchdog Latch function. Ensure that when the jumper is not present or the switch is in the OFF position the Watchdog Latch function is disabled. In this mode of operation, a Watchdog fault will be reset following a power loss, brownout, or power interruption. Ensure that when the jumper is present or the switch is in the ON position the Watchdog Latch function is enabled. In this mode of operation, a Watchdog fault will be retained until a Reset command is issued.

Provide a jumper that will reverse the active polarity for pin #EE (output relay common). Ensure that when the jumper is not present pin #EE (output relay common) will be considered 'Active' at a voltage greater than 70 Vrms and 'Not Active' at a voltage less than 50 Vrms (Caltrans mode). Ensure that when the jumper is present pin #EE (output relay common) will be considered 'Active' at a voltage less than 50 Vrms and 'Not Active' at a voltage greater than 70 Vrms (Failsafe mode).

In addition to the connectors required by CALTRANS' 2009 TEES, provide the conflict monitor with a red interface connector mounted on the front of the monitor. Ensure the connector is a 20 pin, right angle, center polarized, male connector with latching clip locks and polarizing keys. Ensure the right angle solder tails are designed for a 0.062" thick printed circuit board. Keying of the connector shall be between pins 3 and 5, and between 17 and 19. Ensure the connector has two rows of pins with the odd numbered pins on one row and the even pins on the other row. Ensure the connector pin row spacing is 0.10" and pitch is 0.10". Ensure the mating length of the connector pins is 0.24". Ensure the pins are finished with gold plating 30μ" thick.

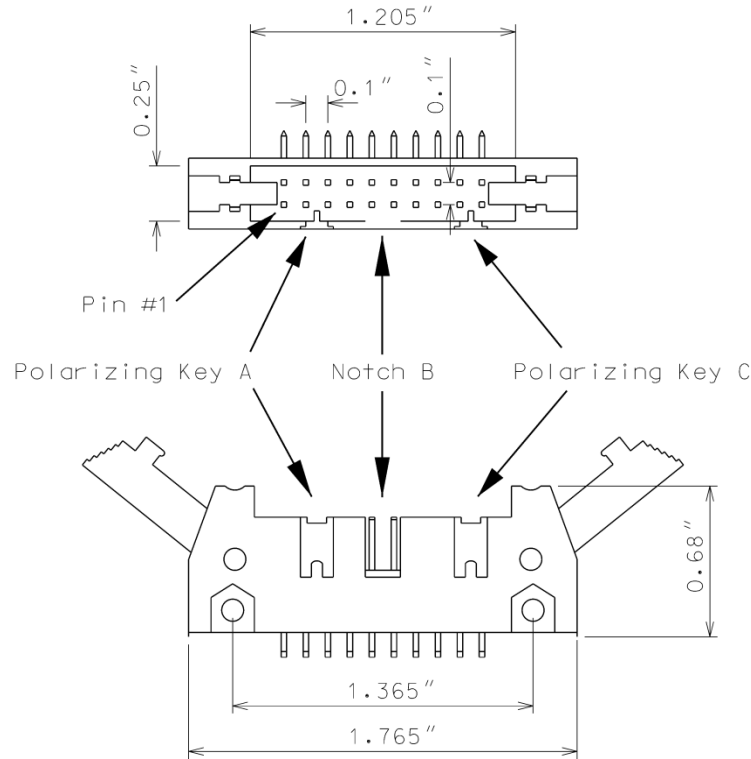

Ensure the red interface connector pins on the monitor have the following functions:

Pin #	Function	Pin #	Function
1	Channel 15 Red	2	Channel 16 Red
3	Channel 14 Red	4	Chassis Ground
5	Channel 13 Red	6	Special Function 2
7	Channel 12 Red	8	Special Function 1
9	Channel 10 Red	10	Channel 11 Red
11	Channel 9 Red	12	Channel 8 Red
13	Channel 7 Red	14	Channel 6 Red
15	Channel 5 Red	16	Channel 4 Red
17	Channel 3 Red	18	Channel 2 Red
19	Channel 1 Red	20	Red Enable

Ensure that removal of the P20 cable connector will cause the conflict monitor to recognize a latching fault condition and place the cabinet into flashing operation.

Provide Special Function 1 and Special Function 2 inputs to the unit which shall disable only Red Fail Monitoring when either input is sensed active. A Special Function input shall be sensed active when the input voltage exceeds 70 Vrms with a minimum duration of 550 ms. A Special Function input shall be sensed not active when the input voltage is less than 50 Vrms or the duration is less

than 250 ms. A Special Function input is undefined by these specifications and may or may not be sensed active when the input voltage is between 50 Vrms and 70 Vrms or the duration is between 250 ms and 550 ms.

Ensure the conflict monitor recognizes field signal inputs for each channel that meet the following requirements:

- consider a Red input greater than 70 Vrms and with a duration of at least 500 ms as an “on” condition;
- consider a Red input less than 50 Vrms or with a duration of less than 200 ms as an “off” condition (no valid signal);
- consider a Red input between 50 Vrms and 70 Vrms or with a duration between 200 ms and 500 ms to be undefined by these specifications;
- consider a Green or Yellow input greater than 25 Vrms and with a duration of at least 500 ms as an “on” condition;
- consider a Green or Yellow input less than 15 Vrms or with a duration of less than 200 ms as an “off” condition; and
- consider a Green or Yellow input between 15 Vrms and 25 Vrms or with a duration between 200 ms and 500 ms to be undefined by these specifications.

Provide a conflict monitor that recognizes the faults specified by CALTRANS’ 2009 TEES and the following additional faults. Ensure the conflict monitor will trigger upon detection of a fault and will remain in the triggered (in fault mode) state until the unit is reset at the front panel or through the external remote reset input for the following failures:

1. **Red Monitoring or Absence of Any Indication (Red Failure):** A condition in which no “on” voltage signal is detected on any of the green, yellow, or red inputs to a given monitor channel. If a signal is not detected on at least one input (R, Y, or G) of a conflict monitor channel for a period greater than 1000 ms when used with a 170 controller and 1500 ms when used with a 2070 controller, ensure monitor will trigger and put the intersection into flash. If the absence of any indication condition lasts less than 700 ms when used with a 170 controller and 1200 ms when used with a 2070 controller, ensure conflict monitor will not trigger. Red fail monitoring shall be enabled on a per channel basis by the use of switches located on the conflict monitor. Have red monitoring occur when all of the following input conditions are in effect:
  - a) Red Enable input to monitor is active (Red Enable voltages are “on” at greater than 70 Vrms, off at less than 50 Vrms, undefined between 50 and 70 Vrms), and
  - b) Neither Special Function 1 nor Special Function 2 inputs are active.
  - c) Pin #EE (output relay common) is not active
2. **Short/Missing Yellow Indication Fault (Clearance Error):** Yellow indication following a green is missing or shorter than 2.7 seconds (with  $\pm 0.1$ -second accuracy). If a channel fails to detect an “on” signal at the Yellow input for a minimum of 2.7 seconds ( $\pm 0.1$  second) following the detection of an “on” signal at a Green input for that channel, ensure that the monitor triggers and generates a clearance/short yellow error fault indication. Short/missing yellow (clearance) monitoring shall be enabled on a per channel basis by the use of switches located on the conflict monitor. This fault shall not occur when the channel is programmed



for Yellow Inhibit, when the Red Enable signal is inactive or pin #EE (output relay common) is active.

3. **Dual Indications on the Same Channel:** In this condition, more than one indication (R,Y,G) is detected as “on” at the same time on the same channel. If dual indications are detected for a period greater than 500 ms, ensure that the conflict monitor triggers and displays the proper failure indication (Dual Ind fault). If this condition is detected for less than 200 ms, ensure that the monitor does not trigger. G-Y-R dual indication monitoring shall be enabled on a per channel basis by the use of switches located on the conflict monitor. G-Y dual indication monitoring shall be enabled for all channels by use of a switch located on the conflict monitor. This fault shall not occur when the Red Enable signal is inactive or pin #EE (output relay common) is active.
4. **Configuration Settings Change:** The configuration settings are comprised of (as a minimum) the permissive diode matrix, dual indication switches, yellow disable jumpers, any option switches, any option jumpers, and the Watchdog Enable switch. Ensure the conflict monitor compares the current configuration settings with the previous stored configuration settings on power-up, on reset, and periodically during operation. If any of the configuration settings are changed, ensure that the conflict monitor triggers and causes the program card indicator to flash. Ensure that configuration change faults are only reset by depressing and holding the front panel reset button for a minimum of three seconds. Ensure the external remote reset input does not reset configuration change faults.

Ensure the conflict monitor will trigger and the AC Power indicator will flash at a rate of  $2 \text{ Hz} \pm 20\%$  with a 50% duty cycle when the AC Line voltage falls below the “drop-out” level. Ensure the conflict monitor will resume normal operation when the AC Line voltage returns above the “restore” level. Ensure the AC Power indicator will remain illuminated when the AC voltage returns above the “restore” level. Should an AC Line power interruption occur while the monitor is in the fault mode, then upon restoration of AC Line power, the monitor will remain in the fault mode and the correct fault and channel indicators will be displayed.

Provide a flash interval of at least 6 seconds and at most 10 seconds in duration following a power-up, an AC Line interruption, or a brownout restore. Ensure the conflict monitor will suspend all fault monitoring functions, close the Output relay contacts, and flash the AC indicator at a rate of  $4 \text{ Hz} \pm 20\%$  with a 50% duty cycle during this interval. Ensure the termination of the flash interval after at least 6 seconds if the Watchdog input has made 5 transitions between the True and False state and the AC Line voltage is greater than the “restore” level. If the watchdog input has not made 5 transitions between the True and False state within  $10 \pm 0.5$  seconds, the monitor shall enter a WDT error fault condition.

Ensure the conflict monitor will monitor an intersection with a minimum of four approaches using the four-section Flashing Yellow Arrow (FYA) vehicle traffic signal as outlined by the NCHRP 3-54 research project for protected-permissive left turn signal displays. Ensure the conflict monitor will operate in the FYA mode and FYAc (Compact) mode as specified below to monitor each channel pair for the following fault conditions: Conflict, Flash Rate Detection, Red Fail, Dual Indication, and Clearance. Provide a switch to select between the FYA mode and FYAc mode. Provide a switch to select each FYA phase movement for monitoring.

## FYA mode

FYA Signal Head	Phase 1	Phase 3	Phase 5	Phase 7
Red Arrow	Channel 9 Red	Channel 10 Red	Channel 11 Red	Channel 12 Red
Yellow Arrow	Channel 9 Yellow	Channel 10 Yellow	Channel 11 Yellow	Channel 12 Yellow
Flashing Yellow Arrow	Channel 9 Green	Channel 10 Green	Channel 11 Green	Channel 12 Green
Green Arrow	Channel 1 Green	Channel 3 Green	Channel 5 Green	Channel 7 Green

## FYAc mode

FYA Signal Head	Phase 1	Phase 3	Phase 5	Phase 7
Red Arrow	Channel 1 Red	Channel 3 Red	Channel 5 Red	Channel 7 Red
Yellow Arrow	Channel 1 Yellow	Channel 3 Yellow	Channel 5 Yellow	Channel 7 Yellow
Flashing Yellow Arrow	Channel 1 Green	Channel 3 Green	Channel 5 Green	Channel 7 Green
Green Arrow	Channel 9 Green	Channel 9 Yellow	Channel 10 Green	Channel 10 Yellow

If a FYA channel pair is enabled for FYA operation, the conflict monitor will monitor the FYA logical channel pair for the additional following conditions:

1. **Conflict:** Channel conflicts are detected based on the permissive programming jumpers on the program card. This operation remains unchanged from normal operation except for the solid Yellow arrow (FYA clearance) signal.
2. **Yellow Change Interval Conflict:** During the Yellow change interval of the Permissive Turn channel (flashing Yellow arrow) the conflict monitor shall verify that no conflicting channels to the solid Yellow arrow channel (clearance) are active. These conflicting channels shall be determined by the program card compatibility programming of the Permissive Turn channel (flashing Yellow arrow). During the Yellow change interval of the Protected Turn channel (solid Green arrow) the conflict monitor shall verify that no conflicting channels to the solid Yellow arrow channel (clearance) are active as determined by the program card compatibility programming of the Protected Turn channel (solid Green arrow).

3. **Flash Rate Detection:** The conflict monitor unit shall monitor for the absence of a valid flash rate for the Permissive turn channel (flashing Yellow arrow). If the Permissive turn channel (flashing Yellow arrow) is active for a period greater than 1600 milliseconds, ensure the conflict monitor triggers and puts the intersection into flash. If the Permissive turn channel (flashing Yellow arrow) is active for a period less than 1400 milliseconds, ensure the conflict monitor does not trigger. Ensure the conflict monitor will remain in the triggered (in fault mode) state until the unit is reset at the front panel or through the external remote reset input. Provide a jumper or switch that will enable and disable the Flash Rate Detection function. Ensure that when the jumper is not present or the switch is in the OFF position the Flash Rate Detection function is enabled. Ensure that when the jumper is present or the switch is in the ON position the Flash Rate Detection function is disabled.
4. **Red Monitoring or Absence of Any Indication (Red Failure):** The conflict monitor unit shall detect a red failure if there is an absence of voltage on all four of the inputs of a FYA channel pair (RA, YA, FYA, GA).
5. **Dual Indications on the Same Channel:** The conflict monitor unit shall detect a dual indication if two or more inputs of a FYA channel pair (RA, YA, FYA, GA) are “on” at the same time.
6. **Short/Missing Yellow Indication Fault (Clearance Error):** The conflict monitor unit shall monitor the solid Yellow arrow for a clearance fault when terminating both the Protected Turn channel (solid Green arrow) interval and the Permissive Turn channel (flashing Yellow arrow) interval.

Ensure that the conflict monitor will log at least nine of the most recent events detected by the monitor in non-volatile EEPROM memory (or equivalent). For each event, record at a minimum the time, date, type of event, status of each field signal indication with RMS voltage, and specific channels involved with the event. Ensure the conflict monitor will log the following events: monitor reset, configuration, previous fault, and AC line. Furnish the signal sequence log that shows all channel states (Greens, Yellows, and Reds) and the Red Enable State for a minimum of 2 seconds prior to the current fault trigger point. Ensure the display resolution of the inputs for the signal sequence log is not greater than 50 ms.

For conflict monitors used within an Ethernet communications system, provide a conflict monitor with an Ethernet 10/100 Mbps, RJ-45 port for data communication access to the monitor by a local notebook computer and remotely via a workstation or notebook computer device connected to the signal system local area network. The Ethernet port shall be electrically isolated from the conflict monitor’s electronics and shall provide a minimum of 1500 Vrms isolation. Integrate monitor with Ethernet network in cabinet. Provide software to retrieve the time and date from a network server in order to synchronize the on-board times between the conflict monitor and the controller. Furnish and install the following Windows based, graphic user interface software on workstations and notebook computers where the signal system client software is installed: 1) software to view and retrieve all event log information, 2) software that will search and display a list of conflict monitor IP addresses and IDs on the network, and 3) software to change the conflict monitor’s network parameters such as IP address and subnet mask.

For non-Ethernet connected monitors, provide a RS-232C/D compliant port (DB-9 female connector) on the front panel of the conflict monitor in order to provide communications from the conflict monitor to the 170/2070 controller or to a Department-furnished laptop computer.

Electrically isolate the port interface electronics from all monitor electronics, excluding Chassis Ground. Ensure that the controller can receive all event log information through a controller Asynchronous Communications Interface Adapter (Type 170E) or Async Serial Comm Module (2070). Furnish and connect a serial cable from the conflict monitor's DB-9 connector to Comm Port 1 of the 2070 controller. Ensure conflict monitor communicates with the controller. Provide a Windows based graphic user interface software to communicate directly through the same monitor RS-232C/D compliant port to retrieve and view all event log information to a Department-furnished laptop computer. The RS-232C/D compliant port on the monitor shall allow the monitor to function as a DCE device with pin connections as follows:

<b>Conflict Monitor RS-232C/D (DB-9 Female) Pinout</b>		
<b>Pin Number</b>	<b>Function</b>	<b>I/O</b>
1	DCD	O
2	TX Data	O
3	RX Data	I
4	DTR	I
5	Ground	-
6	DSR	O
7	CTS	I
8	RTS	O
9	NC	-

---

**MONITOR BOARD EDGE CONNECTOR**

---

<b>Pin #</b>	<b>Function (Back Side)</b>	<b>Pin #</b>	<b>Function (Component Side)</b>
1	Channel 2 Green	A	Channel 2 Yellow
2	Channel 13 Green	B	Channel 6 Green
3	Channel 6 Yellow	C	Channel 15 Green
4	Channel 4 Green	D	Channel 4 Yellow
5	Channel 14 Green	E	Channel 8 Green
6	Channel 8 Yellow	F	Channel 16 Green
7	Channel 5 Green	H	Channel 5 Yellow
8	Channel 13 Yellow	J	Channel 1 Green
9	Channel 1 Yellow	K	Channel 15 Yellow
10	Channel 7 Green	L	Channel 7 Yellow
11	Channel 14 Yellow	M	Channel 3 Green
12	Channel 3 Yellow	N	Channel 16 Yellow
13	Channel 9 Green	P	Channel 17 Yellow
14	Channel 17 Green	R	Channel 10 Green
15	Channel 11 Yellow	S	Channel 11 Green
16	Channel 9 Yellow	T	Channel 18 Yellow
17	Channel 18 Green	U	Channel 10 Yellow
--		--	
18	Channel 12 Yellow	V	Channel 12 Green
19	Channel 17 Red	W	Channel 18 Red
20	Chassis Ground	X	Not Assigned
21	AC-	Y	DC Common
22	Watchdog Timer	Z	External Test Reset
23	+24VDC	AA	+24VDC
24	Tied to Pin 25	BB	Stop Time (Output)
25	Tied to Pin 24	CC	Not Assigned
26	Not Assigned	DD	Not Assigned
27	Relay Output, Side #3, N.O.	EE	Relay Output, Side #2, Common
28	Relay Output, Side #1, N.C.	FF	AC+

-- Slotted for keying between Pins 17/U and 18/V

---

**CONFLICT PROGRAM CARD PIN ASSIGNMENTS**

---

<b>Pin #</b>	<b>Function (Back Side)</b>	<b>Pin #</b>	<b>Function (Component Side)</b>
1	Channel 2 Green	A	Channel 1 Green
2	Channel 3 Green	B	Channel 2 Green
3	Channel 4 Green	C	Channel 3 Green
4	Channel 5 Green	D	Channel 4 Green
5	Channel 6 Green	E	Channel 5 Green
6	Channel 7 Green	F	Channel 6 Green
7	Channel 8 Green	H	Channel 7 Green
8	Channel 9 Green	J	Channel 8 Green
9	Channel 10 Green	K	Channel 9 Green
10	Channel 11 Green	L	Channel 10 Green
11	Channel 12 Green	M	Channel 11 Green
12	Channel 13 Green	N	Channel 12 Green
13	Channel 14 Green	P	Channel 13 Green
14	Channel 15 Green	R	Channel 14 Green
15	Channel 16 Green	S	Channel 15 Green
16	N/C	T	PC AJAR
17	Channel 1 Yellow	U	Channel 9 Yellow
18	Channel 2 Yellow	V	Channel 10 Yellow
19	Channel 3 Yellow	W	Channel 11 Yellow
20	Channel 4 Yellow	X	Channel 12 Yellow
21	Channel 5 Yellow	Y	Channel 13 Yellow
22	Channel 6 Yellow	Z	Channel 14 Yellow
23	Channel 7 Yellow	AA	Channel 15 Yellow
24	Channel 8 Yellow	BB	Channel 16 Yellow
--		--	
25	Channel 17 Green	CC	Channel 17 Yellow
26	Channel 18 Green	DD	Channel 18 Yellow
27	Channel 16 Green	EE	PC AJAR (Program Card)
28	Yellow Inhibit Common	FF	Channel 17 Green

-- Slotted for keying between Pins 24/BB and 25/CC

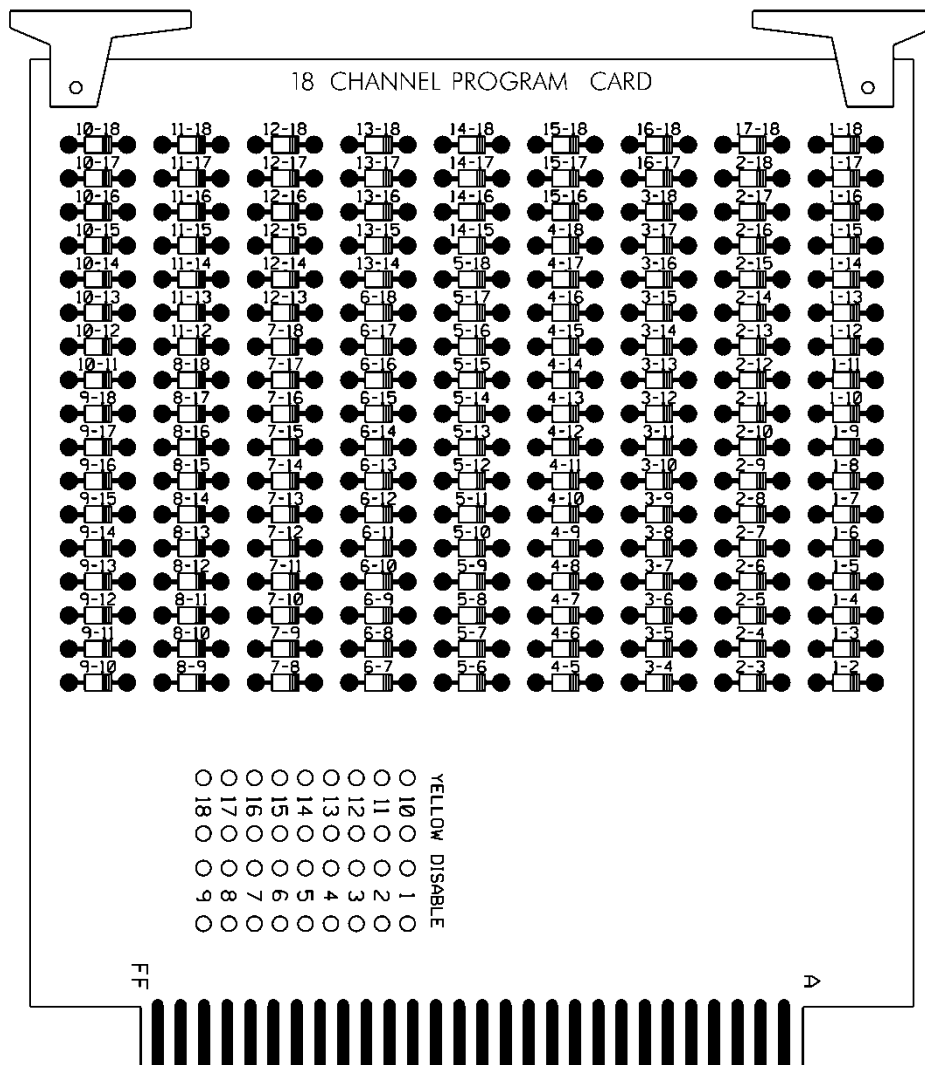

**3.3. MATERIALS – TYPE 170 DETECTOR SENSOR UNITS**

Furnish detector sensor units that comply with Chapter 5 Section 1, “General Requirements,” and Chapter 5 Section 2, “Model 222 & 224 Loop Detector Sensor Unit Requirements,” of the CALTRANS “Transportation Electrical Equipment Specifications” dated March 12, 2009 with Erratum 1.

**3.4. MATERIALS – TYPE 2070LX CONTROLLERS**

Furnish model 2070LX controller units that conform to CALTRANS *Transportation Electrical Equipment Specifications (TEES)* (dated March 12, 2009, plus Errata 1 dated January 21, 2010 and Errata 2 dated December 5, 2014) except as required herein.

The Department will provide software at the beginning of the burning-in period. Contractor shall give 5 working days notice before needing software. Program software provided by the Department.

Provide model 2070LX controllers with Linux kernel 2.6.18 or higher and device drivers, composed of the unit chassis and at a minimum the following modules and assemblies:

- MODEL 2070-1C, CPU Module, Single Board, with 8Mb Datakey (blue in color)
- MODEL 2070-2E+, Field I/O Module (FI/O)
  - Note: Configure the Field I/O Module to disable both the External WDT Shunt/Toggle Switch and SP3 (SP3 active indicator is “off”)
- MODEL 2070-3B, Front Panel Module (FP), Display B (8x40)
- MODEL 2070-4A, Power Supply Module, 10 AMP

Provide a Board Support Package (BSP) to the state and to any specified applications software manufacturer when requested by the state to facilitate the porting of application software.

#### **4. PUSH BUTTON INTEGRATED ACCESSIBLE PEDESTRIAN SIGNAL (APS)**

##### **4.1. DESCRIPTION**

Furnish and install push button integrated accessible pedestrian signals that include pedestrian push button, push button locator tone, raised tactile arrow, audio and vibro-tactile walk indications, automatic volume adjustment, pedestrian information sign, and all necessary hardware. Furnish the R10-3e with appropriate arrow direction for the pedestrian information sign.

##### **4.2. MATERIALS**

Furnish material, equipment, and hardware under this section that is pre-approved on the ITS and Signals QPL.

Provide the accessible pedestrian signals with a 2-inch diameter pedestrian push button that contains a tactile arrow whose direction can be easily adjusted in the field. Ensure each push button actuates a sturdy, momentary, normally-open switch with a minimum rating of 20 million actuations. Include on the button, a raised tactile arrow having a high visual contrast with the remainder of the button face. Ensure the housing is weather-tight and fabricated from aluminum. Ensure the housing is suitable for mounting on wood and metal poles. Paint surfaces of the pedestrian push button housing in highway yellow, unless otherwise specified, with an electrostatically-applied, fused-polyester paint method. Ensure the thickness of the paint is a minimum of 2.5 mils. Provide the pedestrian information sign that is integral to the housing.

Ensure the accessible pedestrian signals can provide tones, sounds, and speech messages that are synchronized at an intersection. Provide a means for adjusting the base sound level for the tones, sounds, and speech messages. Ensure the tones, sounds, and speech messages will adjust automatically to the ambient noise level up to a maximum of 100 dBA. Provide the custom speech messages in both English and Spanish languages. Ensure you can program the accessible pedestrian signal by a means not readily accessible by unauthorized persons.

Ensure each push button provides a standard locator tone that is deactivated when the traffic signal is operating in the flash mode. Provide a user-programmable audible beaconing feature that is initiated by an extended push button press of one second or more. Ensure the audible beaconing feature increases the volume of the push button locator tone during the pedestrian change interval of the called pedestrian phase and operates in one of the following ways:

- A. The louder audible walk indication and louder locator tone comes from the far end of the crosswalk, as pedestrians cross the street,
- B. The louder locator tone comes from both ends of the crosswalk, or



C. The louder locator tone comes from an additional speaker that is aimed at the center of the crosswalk and that is mounted on a pedestrian signal head.

Provide confirmation of the push button activation by an LED pilot light. Ensure the pilot light remains illuminated until the pedestrian's green or WALKING PERSON (symbolizing WALK) signal indication is displayed. Ensure each press of the pushbutton initiates a "wait" speech message during all intervals except the Walk interval.

Ensure you can select a percussive tone and custom speech message to sound during the "Walk" interval. Provide a push button that vibrates during the "Walk" interval. Ensure the "Walk" indications have the same duration as the illuminated pedestrian signals except when the signal is programmed to rest in the walk interval. When the pedestrian signal is programmed to rest in walk, ensure the "Walk" indication is limited to the first 7 seconds of the walk interval. The "Walk" indication shall be recalled by a button press during the walk interval provided that the crossing time remaining is greater than the pedestrian change interval. Ensure the "Walk" indications are deactivated when the traffic control signal is operating in a flashing mode. When audible "Walk" indications are selected as a percussive tone, ensure the tone repeats at 8 to 10 ticks per second and consists of multiple frequencies with a dominant component at 880 Hz.

Ensure the accessible pedestrian signals are weatherproof and suitable for operation in wet locations. Ensure proper operation over a temperature range of -30°F (-34°C) to 165°F (+74°C). Ensure all circuit boards have a moisture resistant coating. Ensure the equipment interfaces and operates properly in a Type-170E cabinet.

#### **4.3. CONSTRUCTION METHODS**

Comply with the requirements of Section 1705 of the *Standard Specifications*. Install in accordance with the manufacturer's recommendations.

Mount push button integrated accessible pedestrian signals in a tamperproof manner on wood and metal poles, signal pedestals, or pushbutton posts as indicated in the signal plans.

Install each pushbutton so that the tactile arrow is pointed in the direction of travel and is aligned parallel to the direction of travel on the associated crosswalk.

Ensure pushbuttons are separated by a distance of at least 10 feet such that they clearly indicate which crosswalk has the WALK indication. Where there are constraints on a particular corner that make it impractical to provide the 10 feet of separation between the two pushbuttons, the pushbuttons may be placed closer together or on the same pole, with approval by the Engineer. If two pushbuttons are placed on the same pole or with less than 10 feet separation, provide a speech walk message for the WALK indication and a speech pushbutton information message.

Adjust the intensity of the pushbutton locator tones so they are audible 6 feet to 12 feet from the pushbutton, or to the building line, whichever is less. Ensure the pushbutton locator tones are no more than 5 dBA louder than ambient sound. Configure audible "Walk" indication to be audible at the nearest end of the associated crosswalk.

If speech messages are used, have each recorded custom speech message approved by the Engineer in advance.

#### **4.4. MEASUREMENT AND PAYMENT**

Actual number of push button integrated accessible pedestrian signal detector stations furnished, installed, and accepted.

Actual number of central control units for APS detector stations furnished, installed, and accepted.

No measurement will be made of cables or hardware, as these will be considered incidental to furnishing and installing push button integrated accessible pedestrian signals.

Payment will be made under:

APS Detector Stations.....	Each
Central Control Units For APS Detector Stations .....	Each

**5. VIDEO IMAGING LOOP EMULATOR DETECTOR SYSTEMS**

**5.1. DESCRIPTION**

Design, furnish, provide training, and install video imaging loop emulator detection systems with all necessary hardware in accordance with the plans and specifications.

Unless otherwise specified in the contract, all loop emulator detection equipment will remain the property of the contractor.

**5.2. MATERIALS**

**A. General:**

Material and equipment furnished under this section must be pre-approved on the Department’s QPL by the date of installation except miscellaneous hardware such as cables and mounting hardware do not need to be pre-approved.

Used equipment will be acceptable provided the following conditions have been met:

- Equipment is listed on the current QPL.
- Equipment is in good working condition.
- Equipment is to remain the property of the contractor.

Ensure that software is licensed for use by the Department and by any other agency responsible for maintaining or operating the loop emulation system. Provide the Department with a license to duplicate and distribute the software as necessary for design and maintenance support.

Design and furnish video imaging loop emulator detection systems that detect vehicles at signalized intersections by processing video images and providing detection outputs to the signal controller in real time (within 112 milliseconds of vehicle arrival).

Furnish all required camera sensor units, loop emulator processor units, hardware and software packages, cabling, poles, mast arms, harnesses, camera mounting assemblies, surge protection panels, grounding systems, messenger cable and all necessary hardware. Furnish systems that allow the display of detection zones superimposed on an image of the roadway on a Department-furnished monitor or laptop computer screen. Ensure detection zones can be defined and data entered using a simple keyboard or mouse and monitor, or using a laptop PC with software.

Provide design drawings showing design details and camera sensor unit locations for review and acceptance before installation. Provide mounting height and location requirements for camera sensor units on the design based on site survey. Design video imaging loop emulator detection systems with all necessary hardware. Indicate all necessary poles, spans, mast arms, luminaire arms, cables, camera mounting assemblies and hardware to achieve the required detection zones where

Department owned poles are not adequate to locate the camera sensor units. Do not design for the installation of poles in medians.

Obtain the Engineer's approval before furnishing video imaging loop emulator detection systems. The contractor is responsible for the final design of video imaging loop emulator detection systems. Review and acceptance of the designs by the Department does not relieve the contractor from the responsibility to provide fully functional systems and to ensure that the required detection zones can be provided.

Provide the ability to program each detection call (input to the controller) with the following functions:

- Full Time Delay – Delay timer is active continuously,
- Normal Delay – Delay timer is inhibited when assigned phase is green (except when used with TS 2 and 170/2070L controllers),
- Extend – Call is extended for this amount of time after vehicle leaves detection area,
- Delay Call/Extend Call – This feature uses a combination of full time delay and extend time on the same detection call. Ensure operation is as follows: Vehicle calls are received after the delay timer times out. When a call is detected, it is held until the detection area is empty and the programmed extend time expires. If another vehicle enters the detection area before the extend timer times out, the call is held and the extend time is reset. When the extend timer times out, the delay timer has to expire before another vehicle call can be received.

Provide the ability to program each detection zone as one of the following functions:

- Presence detector,
- Directional presence detector,
- Pulse detector,
- Directional pulse detector.

Ensure previously defined detector zones and configurations can be edited.

Provide each individual system with all the necessary equipment to focus and zoom the camera lenses without the need to enter the camera enclosure.

Provide systems that allow for the placement of at least 8 detection zones within the combined field of view of a single camera sensor unit. Provide a minimum of 8 detection outputs per camera.

Provide detection zones that can be overlapped. Ensure systems reliably detect vehicles when the horizontal distance from the camera sensor unit to the detection zone area is less than ten times the mounting height of the sensor. Ensure systems detect vehicles in multiple travel lanes.

Ensure systems can detect vehicle presence within a 98 to 102 percent accuracy (up to 2 percent of the vehicles missed and up to 2 percent of false detection) for clear, dry, daylight conditions, a 96 to 105 percent accuracy (up to 4 percent of the vehicles missed and up to 5 percent false detection) for dawn and dusk conditions, and a 96 percent accuracy (up to 4 percent of the vehicles missed) for night and adverse conditions (fog, snow, rain, etc.) using standard sensor optics and in the absence of occlusion.

Repair and replace all failed components within 72 hours.

The Department may conduct field-testing to ensure the accuracy of completed video imaging loop emulator detection systems.

**B. Loop Emulator System:**

Furnish loop emulator systems that receive and simultaneously process information from camera sensor units, and provides detector outputs to signal controllers.

Ensure systems provide the following:

- Operate in a typical roadside environment and meet the environmental specifications and are fully compatible with NEMA TS 1, NEMA TS 2, or Type 170/2070L controllers and cabinets,
- provide a “fail-safe” mode whereby failure of one or more of the camera sensor units or power failure of the loop emulator system will cause constant calls to be placed on the affected vehicle detection outputs to the signal controller,
- provide compensation for minor camera movement of up to 2 percent of the field of view at 400 feet without falsely detecting vehicles,
- process the video at a minimum rate of 30 times per second,
- provide separate wired connectors inside the controller cabinet for video recording each camera,
- provide remote video monitoring with a minimum refresh rate at 1 frame per second over a standard dial-up telephone line,
- provide remote video detection monitoring.

Furnish camera sensor units that comply with the following:

- have an output signal conforming to EIA RS-170 standard,
- have a nominal output impedance of 75 ohms,
- be immune to bright light sources, or have built in circuitry or protective devices to prevent damage to the sensor when pointed directly at strong light sources,
- be housed in a light colored environmental enclosure that is water proof and dust tight, and that conforms to NEMA-4 specifications or better,
- simultaneously monitor at least five travel lanes when placed at the proper mounting location with a zoom lens,
- have a sunshield attached to the environmental enclosure to minimize solar heating,
- meet FCC class B requirements for electromagnetic interference emissions,
- have a heater attached to the viewing window of the environmental enclosure to prevent ice and condensation in cold weather.

Where coaxial video cables and other cables are required between the camera sensor and other components located in the controller cabinet, furnish surge protection in the controller cabinet.

If furnishing coaxial communications cable comply with the following, as recommended by the approved loop emulator manufacturer:

- Number 20 AWG, solid bare copper conductor terminated with crimped-on BNC connectors (do not use BNC adapters) from the camera sensor to the signal controller cabinet.
- Number 22 AWG, stranded bare copper conductor terminated with crimped-on BNC connectors (do not use BNC adapters) from the camera sensor unit to the junction box, and within the signal controller cabinet.

Furnish power cable appropriately sized to meet the power requirements of the sensors. At a minimum, provide three conductor 120 VAC field power cable.

As determined during the site survey, furnish sensor junction boxes with nominal 6 x 10 x 6 inches dimensions at each sensor location. Provide terminal blocks and tie points for coaxial cable.

### **C. Video Imaging Loop Emulator System Support:**

Furnish video imaging loop emulator systems with either a simple keyboard or a mouse with monitor and appropriate software, or with system software for use on department-owned laptop PCs. Ensure the system is Windows 2000 and Windows XP compatible.

Provide Windows 2000 and Windows XP compatible personal computer software, if needed, to provide remote video and video detection monitoring.

Ensure systems allow the user to edit previously defined detector configurations. When a vehicle is within a detection zone, provide for a change in color or intensity of the detection zone perimeter or other appropriate display changes on the Department-furnished monitor or laptop computer screen.

Provide cabling and interconnection hardware with 6-foot minimum length interconnection cable to interface with the system.

Provide all associated equipment manuals and documentation.

### **5.3. CONSTRUCTION METHODS**

Arrange and conduct site surveys with the system manufacturer's representative and Department personnel to determine proper camera sensor unit selection and placement. Provide the Department at least 3 working days notice before conducting site surveys. Upon completion of the site surveys the Department will provide revised plans reflecting the findings of the site survey.

Before beginning work at locations requiring video imaging loop emulator detection systems, furnish system software. Upon activation of detection zones, provide detector configuration files. Ensure that up-to-date detection configuration files are furnished for various detection zone configurations that may be required for construction phasing.

Place into operation loop emulator detection systems. Configure loop emulator detection systems to achieve required detection in designated zones. Have a certified manufacturer's representative on site to supervise and assist with installation, set up, and testing of the system.

Install the necessary processing and communications equipment in the signal controller cabinet. Make all necessary modifications to install equipment, cabling harnesses, and camera sensor interface panels with surge suppression.

Perform modifications to camera sensor unit gain, sensitivity, and iris limits necessary to complete the installation.

Do not install camera sensor units on signal poles unless approved by the Engineer.

Install the necessary cables from each sensor to the signal controller cabinet along signal cabling routes. Install surge protection and terminate all cable conductors.

Relocate camera sensor units and reconfigure detection zones as necessary according to the plans for construction phases.

Provide at least 8 hours of training on the set up, operation, troubleshooting, and maintenance of the loop emulator detection system to a maximum of ten Department personnel. Arrange for training to be conducted by the manufacturer’s representative at an approved site within the Division responsible for administration of the project. Thirty days before conducting training submit a detailed course curriculum, draft manuals and materials, and resumes. Obtain approval of the submittal before conducting the training. At least one week before beginning training, provide three sets of complete documentation necessary to maintain and operate the system. Do not perform training until installation of loop emulator detection systems is complete.

**5.4. MEASUREMENT AND PAYMENT**

Actual number of site surveys, arranged, conducted, and accepted.

Actual number of cameras without internal loop emulator processing units furnished, installed, and accepted.

Actual number of external loop emulator processing units furnished, installed, and accepted.

Actual number of camera sensor units relocated with detection zones reconfigured installed, and accepted.

No measurement will be made of video imaging loop emulator system support or training, power and video cables, and trenching as these items will be considered incidental to furnishing and installing video imaging loop emulator detection systems.

Payment will be made under:

Site Survey .....	Each
Camera without Internal Loop Emulator Processing Unit.....	Each
External Loop Emulator Processing Unit .....	Each
Relocate Camera Sensor Unit .....	Each

**6. METAL POLE SUPPORTS**

**6.1. METAL POLES**

**A. General:**

Furnish and install metal poles, grounding systems, and all necessary hardware. Work covered under this special provision includes requirements for design, fabrication, and installation of standard and custom/site-specific designed metal pole supports and associated foundations.

Comply with applicable sections of the 2018 STANDARD SPECIFICATIONS FOR ROADS & STRUCTURES, hereinafter referred to as the Standard Specifications. Provide designs of completed assemblies with hardware equaling or exceeding AASHTO Standard Specifications for Structural Supports for Highway Signs, Luminaires and Traffic Signals 6<sup>th</sup> Edition, 2013 (hereinafter called 6<sup>th</sup> Edition AASHTO), including the latest interim specifications. Provide assemblies with a round or near-round (18 sides or more) cross-section, or a multi-sided cross section with no less than six sides. The sides may be straight, convex, or concave.

For bid purposes, pole heights shown on plans are estimated from available data. Prior to furnishing metal poles, use field measurements and adjusted cross-sections to determine whether pole heights will meet required clearances. If pole heights do not meet required clearances, the Contractor should immediately notify the Engineer of the required revised pole heights.

Standard Drawings for Metal Poles are available that supplement these project special provisions. The drawings are located on the Department's website:

<https://connect.ncdot.gov/resources/safety/pages/ITS-Design-Resources.aspx>

Comply with article 1098-1B of the *Standard Specifications* for submittal requirements. Furnish shop drawings for approval. Provide copies of detailed shop drawings for each type of structure as summarized below. Ensure shop drawings include material specifications for each component. Ensure shop drawings identify welds by type and size on the detail drawing only, not in table format. **Do not release structures for fabrication until shop drawings have been approved by NCDOT.** Ensure shop drawings contain an itemized bill of materials for all structural components and associated connecting hardware.

Comply with article 1098-1A of the *Standard Specifications* for Qualified Products List (QPL) submittals. All shop drawings must include project location description, signal or asset inventory number(s) and project number or work order number.

Summary of information required for metal pole review submittal:

Item	Electronic Submittal	Comments / Special Instructions
Sealed, Approved Signal or ITS Plan/Loading Diagram	1 set	All structure design information needs to reflect the latest approved Signal or ITS plans
Custom Pole Shop Drawings	1 set	Submit drawings on 11" x 17" format media. Show NCDOT signal or asset inventory number(s), Contractor's name and relevant revision number in the title block. All drawings must have a <u>unique drawing number</u> for each project.
Standard Strain Pole Shop Drawings (from the QPL)	1 set	Submit drawings on 11" x 17" format media. Show NCDOT signal inventory number(s), Contractor's name and relevant revision number in the title block. All drawings must have a <u>unique drawing number</u> for each project.
Structure Calculations	1 set	Not required for Standard QPL Poles
Standard Strain Pole Foundation Drawings	1 set	Submit drawings on 11" x 17" format media. Submit a completed Standard Foundation Selection form for each pole using foundation table on Metal Pole Drawing M8.
Custom Foundation Drawings	1 set	Submit drawings on 11" x 17" format media. Show NCDOT signal or asset inventory number(s), Contractor's name and relevant revision number in the title block. All drawings must have a <u>unique drawing number</u> for each project.  If QPL Poles are used, include the corresponding QPL pole shop drawings with this submittal.

Foundation Calculations	1 set	<b>Submit copies of LPILE input, output, and pile tip deflection graph per Section titled Drilled Pier Foundations for Metal Poles of this specification for each foundation.</b> Not required for Standard Strain Poles (from the QPL)
Soil Boring Logs and Report	1 set	Report shall include a location plan and a soil classification report including soil capacity, water level, hammer efficiency, soil bearing pressure, soil density, etc. for each pole.

**NOTE** – All shop drawings and custom foundation design drawings must be sealed by a Professional Engineer licensed in the state of North Carolina. All geotechnical information must be sealed by either a Professional Engineer or Geologist licensed in the state of North Carolina. Include a title block and revision block on the shop drawings and foundation drawings showing the NCDOT signal or asset inventory number(s).

**Shop drawings and foundation drawings may be submitted together or separately for approval. However, shop drawings must be approved before foundations can be reviewed.** Foundation designs will be returned without review if the associated shop drawing has not been approved. Boring reports shall include the following: Engineer’s summary, boring location maps, soil classification per AASHTO Classification System, hammer efficiency, and Metal Pole Standard Foundation Selection Form. Incomplete submittals will be returned without review. The Reviewer has the right to request additional analysis and copies of the calculations to expedite the approval process.

#### **B. Materials:**

Fabricate metal pole from coil or plate steel that meet the requirements of ASTM A 595 Grade A tubes. For structural steel shapes, plates, and bars use, as a minimum, ASTM A572 Gr 50, AASHTO M270 Gr 50, ASTM A709 Gr 50, or an approved equivalent. Provide pole shafts of round or near round (18 sides or more) cross-section, or multi-sided tubular cross-section with no less than six sides, having a uniform linear taper of 0.14 in/ft. Construct shafts from one piece of single-ply plate or coil. For anchor base fabrication, conform to the applicable bolt pattern and orientation as shown on Metal Pole Standard Drawing Sheet M2.

Use the submerged arc process, or other NCDOT previously approved process suitable for shafts, to continuously weld pole shafts along their entire length. Finish the longitudinal seam weld flush with the outside contour of the base metal. Ensure shaft has no circumferential welds except at the lower end joining the shaft to the pole base. Use full penetration groove welds with backing ring for all tube-to-transverse-plate connections in accordance with 6<sup>th</sup> Edition AASHTO. Provide welding that conforms to Article 1072-18 of the *Standard Specifications*. No field welding on any part of the pole will be permitted unless approved by a qualified Engineer.

After fabrication, hot-dip galvanize steel poles and all assembly components in accordance with section 1076-3 of the *Standard Specifications*. Design structural assemblies with weep holes large enough and properly located to drain molten zinc during the galvanization process. Galvanize hardware in accordance with section 1076-4 of the *Standard Specifications*. Ensure threaded material is brushed and retapped as necessary after galvanizing. Perform repair of damaged galvanizing in accordance with section 1076-7 of the *Standard Specifications*. *Ensure* all hardware is galvanized steel or stainless steel. The Contractor is responsible for ensuring the



Designer/Fabricator specifies connecting hardware and/or materials that prevent a dissimilar metal corrosive reaction.

Ensure each anchor rod is 2-inch minimum diameter and 60-inch length. Provide 10-inch minimum thread projection at the top of the rod, and 8-inch minimum at the bottom of the rod. Use anchor rod assembly and drilled pier foundation materials complying with SP09\_R005, hereinafter referred to as *Foundations and Anchor Rod Assemblies for Metal Poles*.

Ensure anchor bolt hole diameters are ¼-inch larger than the anchor bolt diameters in the base plate.

Provide a circular anchor bolt lock plate securing the anchor bolts at the embedded end with two (2) washers and two (2) nuts. Provide a base plate template matching the bolt circle diameter of the anchor bolt lock plate. Construct plates and templates from ¼-inch minimum thick steel with a minimum width of 4 inches. Hot-dip galvanizing is not required for both plates.

Provide four (4) heavy hex nuts and four (4) flat washers for each anchor bolt. For nuts, use AASHTO M291 grade 2H, DH, or DH3 or equivalent material. For flat washers, use AASHTO M293 or equivalent material. Ensure anchor bolts have required diameters, lengths, and positions, and will develop strengths comparable to their respective poles.

For each pole, provide a grounding lug with a ½-inch minimum thread diameter, coarse thread stud and nut that will accommodate #4 AWG ground wire. Ensure the lug is electrically bonded to the pole and is conveniently located inside the pole at the hand hole.

Provide a removable pole cap with stainless steel attachment screws for the top of each pole. Ensure cap is cast aluminum conforming to Aluminum Association Alloy 356.0F. Furnish cap attached to the pole with a sturdy stainless-steel chain that is long enough to permit cap to hang clear of the pole-top opening when cap is removed.

Where required by the plans, furnish couplings 42 inches above bottom of the pole base for mounting of pedestrian pushbuttons. Provide mounting points consisting of 1½-inch internally threaded half-couplings complying with the NEC, mounted within the poles. Ensure that couplings are essentially flush with the outside surfaces of the poles and are installed before any required hot-dip galvanizing. Provide a threaded plug in each mounting point. Ensure the surface of the plug is essentially flush with the outer end of the mounting point when installed and has a recessed slot that will accommodate a ½ "drive standard socket wrench.

Metal poles may be erected and fully loaded after concrete has attained a minimum allowable compressive strength of 3,000 psi.

Connect poles to grounding electrodes and bond them to the electrical service grounding electrodes.

When field drilling is necessary for wire or cable entrances into the pole, comply with the following requirements:

- Do not drill holes within 2 inches of any welds.
- Do not drill any holes larger than 3 inches in diameter without checking with the ITS & Signals Structure Engineers.
- Avoid drilling multiple holes along the same cross section of tube shafts.
- Install rubber grommets in all field drilled holes that wire, or cable will directly enter unless holes are drilled for installation of weather heads or couplings.

- Treat the inside of the drilled holes and repair all galvanized surfaces in accordance with Section 1076-7 of the latest edition of the *Standard Specification prior to installing grommets, caps, or plugs.*
- Cap or plug any existing field drilled holes that are no longer used with rubber, aluminum, or stainless-steel hole plugs.

When street lighting is installed on metal signal structures, isolate the conductors feeding the luminaires inside the pole shaft using liquid tight flexible metal conduit (Type LFMC), liquid tight flexible nonmetallic conduit (Type LFNC), high density polyethylene conduit (Type HDPE), or approved equivalent.. All conductors supplying power for luminaires must run through an external disconnect prior to entrance into the structure. Comply with applicable National Electrical Safety Codes (NEC). Refer to Article “G” Luminaire Arms.

Install a ¼-inch thick plate for a concrete foundation tag to include the following information: concrete grade, depth, diameter, and reinforcement sizes of the installed foundation. Install galvanized wire mesh to cover gap between the base plate and top of foundation for debris and pest control. Refer to standard drawing M7 for further details.

Immediately notify the Engineer of any structural deficiency that becomes apparent in any assembly, or member of any assembly, because of the design requirements imposed by these specifications, the plans, or the typical drawings.

### C. Design:

Unless otherwise specified, design all metal pole support structures using the following 6<sup>th</sup> Edition AASHTO specifications:

- Design for a 50-year service life as recommended by Table 3.8.3-2.
- Use wind pressure map developed from 3-second gust speeds, as provided in Section 3.8.
- Assume wind loads as shown in Figures 3.9.4.2-2 and 3.9.4.2-3 of the 6<sup>th</sup> Edition AASHTO for Group III loading with Ice.
- Ensure metal pole support structures include natural wind gust loading and truck-induced gust loading for fatigue design, as provided in Sections 11.7.1.2 and 11.7.1.3, respectively. Designs need not consider periodic galloping forces.
- Assume 11.2 mph natural wind gust speed in North Carolina. For natural wind fatigue stress calculations, utilize a drag coefficient ( $C_d$ ) based on the yearly mean wind velocity of 11.2 mph.
- When selecting Fatigue Importance Factors, utilize Fatigue Importance Category II, as provided for in Table 11.6-1, unless otherwise specified.
- Calculate all stresses using applicable equations from Section 5. The Maximum allowable stress ratio for all metal pole support designs is 0.9.
- Conform to Sections 10.4.2 and 11.8 for deflection requirements. For CCTV support structures, ensure maximum deflection at top of pole does not exceed 2.0 percent of pole height.
- Assume the combined minimum weight of a messenger cable bundle (including messenger cable, signal cable and detector lead-in cables) is 1.3 lbs/ft. Assume the combined minimum diameter of the cable bundle is 1.3 inches.

Unless otherwise specified by special loading criteria, the following computed surface area for ice load on signal heads shall be used:

- 3-section, 12-inch, Surface area: 26.0 ft<sup>2</sup>
- 4-section, 12-inch, Surface area: 32.0 ft<sup>2</sup>
- 5-section, 12-inch, Surface area: 42.0 ft<sup>2</sup>

Design a base plate for each pole. The minimum base plate thickness for all poles is determined by the following criteria:

Case 1 Circular or rectangular solid base plate with the upright pole welded to the top surface of base plate with full penetration butt weld, where no stiffeners are provided. A base plate with a small center hole, which is less than 1/3 of the upright diameter, and located concentrically with the upright pole, may be considered as a solid base plate.

The magnitude of bending moment in the base plate, induced by the anchoring force of each anchor bolt is  $M = (P \times D_1) / 2$ , where

M = bending moment at the critical section of the base plate induced by one (1) anchor bolt

P = anchoring force of each anchor bolt

D<sub>1</sub> = horizontal distance between the anchor bolt center and the outer face of the upright, or the difference between the bolt circle radius and the outside radius of the upright

Locate the critical section at the face of the anchor bolt and perpendicular to the bolt circle radius. The overlapped part of two (2) adjacent critical sections is considered ineffective.

Case 2 Circular or rectangular base plate with the upright pole socketed into and attached to the base plate with two (2) lines of fillet weld, and where no stiffeners are provided, or any base plate with a center hole that is larger in diameter than 1/3 of the upright diameter.

The magnitude of bending moment induced by the anchoring force of each anchor bolt is  $M = P \times D_2$ ,

where P = anchoring force of each anchor bolt

D<sub>2</sub> = horizontal distance between the face of the upright and the face of the anchor bolt nut

Locate the critical section at the face of the anchor bolt top nut and perpendicular to the radius of the bolt circle. The overlapped part of two (2) adjacent critical sections is considered ineffective.

If the base plate thickness calculated for Case 2 is less than Case 1, use the thickness calculated for Case 1.

The following additional requirements apply concerning pole base plates.

- Ensure that whichever case governs as defined above, the anchor bolt diameter is set to match the base plate thickness. If the minimum diameter required for the anchor bolt exceeds the thickness required for the base plate, set the base plate thickness equal to the required bolt diameter.
- For all metal poles, use a full penetration groove weld with a backing ring to connect the pole upright component to the base. Refer to Metal Pole Standard Drawing Sheet M3 or M4.

The Professional Engineer is wholly responsible for the design of all poles. Review and acceptance of these designs by the Department does not relieve the said Professional Engineer of his or her responsibility.

#### D. Strain Poles:

Refer to Metal Pole Standard Drawing Sheets M2 and M3 for fabrication details.

Provide two (2) messenger cable (span wire) clamps and associated hardware for attachment of messenger cable. Ensure diameter of the clamp is appropriate to its location on the pole and is appropriately designed for adjustment from 1'-6" below the top, down to 6'-6" below the top of the pole. Do not attach more than one (1) support cable to a messenger cable clamp.

Provide a minimum of three (3) 2-inch holes equipped with an associated coupling and weatherhead on the messenger cable load side of the pole to accommodate passage of signal cables from inside the pole. Provide galvanized threaded plugs for all unused couplings at pole entrance points. Refer to Metal Pole Standard Drawing Sheet M3 for fabrication details.

Provide designs with a 6" x 12" hand hole with reinforcing frame for each pole.

Provide a terminal compartment with cover and screws in each pole encompassing the hand hole and containing a 12-terminal barrier type terminal block. Provide two (2) terminal screws with a removable shorting bar between them for each termination. Furnish terminal compartment covers attached to the pole by a sturdy chain or cable approved by the Engineer. Ensure chain or cable is long enough to permit cover to hang clear of the compartment opening when cover is removed and is strong enough to prevent vandalism. Ensure chain or cable will not interfere with service to cables in the pole base.

Have poles permanently stamped above the hand holes with the identification tag details as shown on Metal Pole Standard Drawing Sheets M2 and M3.

Provide grounding lug(s) in the approximate vicinity of the messenger cable clamp for bonding and grounding messenger cable. Lugs must accept #4 AWG wire to bond messenger cables to the pole in order to provide an effective ground fault circuit path. Refer to Metal Pole Standard Drawing Sheet M6 for construction details.

Install metal poles, hardware, and fittings as shown on the manufacturer's installation drawings. Ensure the installed pole, when fully loaded, is within 1 degree 40 minutes ( $1^{\circ}40'$ ) of vertical. Install poles with the manufacturer's recommended "rake." Where required, use threaded leveling nuts to establish rake.

## 6.2. DRILLED PIER FOUNDATIONS FOR METAL POLES

Analysis procedures and formulas shall be based on AASHTO 6<sup>th</sup> Edition, latest ACI-318 code and the *Drilled Shafts: Construction Procedures and Design Methods* FHWA-NHI-10-016 manual. Design methods based on engineering publications or research papers must have prior approval from NCDOT. The Department reserves the right to accept or reject any method used for the analysis.

Use the following Safety Factors for the foundation design:

- 1.0 x Service (Unfactored) Loads for LPile Shaft Lateral Deflection
- 1.3 x Torsion (Unfactored) Load for Drilled Shaft Concrete and Steel Strength
- (1.3 / 1.33) x Torsion (Unfactored) Load for Shaft Soil-to-Concrete Torsion Capacity
- (2.0 / 1.33) x Axial (Unfactored) Load for Shaft Axial Capacity in Soil

Ensure deflection at top of foundation does not exceed 1 inch for worst-case lateral load.

Use LPILE Plus V6.0 or later for lateral analysis. Submit inputs, results and corresponding graphs with the design calculations.

Calculate skin friction using the  $\alpha$ -method for cohesive soils and the  $\beta$ -method for cohesion-less soils (**Broms method will not be accepted**). Detailed descriptions of the " $\alpha$ " and " $\beta$ " methods can be found in *FHWA-NHI-10-016*.

Omit first 2.5 feet for cohesive soils when calculating skin friction.

Assume a hammer efficiency of 0.70 unless value is provided.

Design custom foundations to carry maximum capacity of each metal pole. For standard case strain poles with custom design, use actual shear, axial and moment reactions from the Standard Strain Pole Foundation Selection Table shown on Standard Drawing No. M8.

When poor soil conditions are encountered, which could create an excessively large foundation design, consideration may be given to allow an exemption to the maximum capacity design. The Contractor must gain approval from the Engineer before reducing a foundation's capacity. On projects where poor soil is known to be present, the Contractor should have foundation designs approved before releasing poles for fabrication.

Have the Contractor notify the Engineer if the proposed foundation is to be installed on a slope other than 8H: 1V or flatter.

#### **A. Description:**

Furnish and install foundations for NCDOT metal poles with all necessary hardware in accordance with the plans and specifications.

Metal Pole Standards have been developed and implemented by NCDOT for use at signalized intersections in North Carolina. If the plans call for a standard strain pole, then a standard foundation may be selected from the plans. However, the Contractor is not required to use a standard foundation. If the Contractor chooses to design a non-standard site-specific foundation for a standard strain pole or if the plans call for a non-standard site-specific pole, design the foundation to conform to the applicable provisions in the NCDOT Metal Pole Standard Drawings and Section B4 (Non-Standard Foundation Design) below. If non-standard site-specific foundations are designed for standard QPL approved strain poles, the foundation designer must use the design moment specified by load case on Metal Pole Standard Drawing Sheet M8. Failure to conform to this requirement will be grounds for rejection of the design.

If the Contractor chooses to design a non-standard foundation for a standard strain pole and the soil test results indicate a standard foundation is feasible for the site, the Contractor will be paid the cost of the standard foundation. Any additional cost associated with a non-standard site-specific foundation including additional materials, labor and equipment will be considered incidental to the cost of the standard foundation. All costs for the non-standard foundation design will be considered incidental to the cost of the standard foundation.

#### **B. Soil Test and Foundation Determination:**

##### **1. General:**

Drilled piers are reinforced concrete sections, cast-in-place against in situ, undisturbed material. Drilled piers are of straight shaft type and vertical.

##### **2. Soil Test:**

Perform a soil test at each proposed metal pole location. Complete all required fill placement and excavation at each pole location to finished grade before drilling each boring. Soil tests performed that are not in compliance with this requirement may be rejected and will not be paid. Drill one boring to a depth of 26 feet within a 25-foot radius of each proposed foundation.

Perform standard penetration tests (SPT) in accordance with ASTM D 1586 at depths of 1, 2.5, 5, 7.5, 10, 15, 20 and 26 feet. Discontinue the boring if one of the following occurs:

- A total of 100 blows have been applied in any two consecutive 6-inch intervals.
- A total of 50 blows have been applied with < 3-inch penetration.

Describe each pole location along the project corridor in a manner that is easily discernible to both the Contractor's Designer and NCDOT Reviewers. If the pole is at an intersection, label the boring the "Intersection of (Route or SR #), (Street Name) and (Route or SR #), (Street Name), \_\_\_\_\_ County, Signal or Asset Inventory No. \_\_\_\_\_". Label borings with "B- N, S, E, W, NE, NW, SE or SW" corresponding to the quadrant location within the intersection.

If the pole location is located between intersections, provide a coordinate location and offset, or milepost number and offset. Pole numbers should be made available to the Drill Contractor. Include pole numbers in the boring label if they are available. If they are not available, ensure the boring labels can be cross-referenced to corresponding pole numbers. For each boring, submit a legible (hand-written or typed) boring log signed and sealed by a licensed Geologist or Professional Engineer registered in North Carolina. Include on each boring the SPT blow counts and N-values at each depth, depth of the boring, hammer efficiency, depth of water table and a general description of the soil types encountered using the AASHTO Classification System.

Borings that cannot be easily correlated to their specific pole location will be returned to the Contractor for clarification; or if approved by the Engineer, the foundation may be designed using the worst-case soil condition obtained as part of this project.

### 3. Standard Foundation Determination:

Use the following method for determining the Design N-value:

$$N_{AVG} = \frac{N_{@1'} + N_{@2.5'} + \dots + N_{@Deepest\ Boring\ Depth}}{\text{Total Number of } N \text{ values}}$$

$$Y = (N_{@1'})^2 + (N_{@2.5'})^2 + \dots + (N_{@Deepest\ Boring\ Depth})^2$$

$$Z = N_{@1'} + N_{@2.5'} + \dots + N_{@Deepest\ Boring\ Depth}$$

$$N_{STD\ DEV} = \sqrt{\left( \frac{(\text{Total Number of } N \text{ values} \times Y) - Z^2}{(\text{Total Number of } N \text{ values}) \times (\text{Total Number of } N \text{ values} - 1)} \right)}$$

**Design N-value** equals lesser of the following two conditions:

$$N_{AVG} - (N_{STD\ DEV} \times 0.45)$$

**OR**

$$\text{Average of First Four (4) } N \text{ values} = \frac{N_{@1'} + N_{@2.5'} + N_{@5'} + N_{@7.5'}}{4}$$

*Note: If less than four (4) N-values are obtained because of criteria listed in Section 2 above, use average of N-values collected for second condition. Do not include the N-value at the deepest boring depth for above calculations if the boring is discontinued at or before the required boring depth because of criteria listed in Section 2 above. Use N-value of zero (0) for weight of hammer or weight of rod. If N-value is greater than fifty (50), reduce N-value to fifty (50) for calculations.*

If standard NCDOT strain poles are shown on the plans and the Contractor chooses to use standard foundations, determine a drilled pier length, "L," for each signal pole from the Standard Strain Pole Foundations Chart (sheet M8) based on the Design N-value and the predominant soil type. For each standard pole location, submit a completed "Metal Pole Standard Foundation Selection Form" signed by the Contractor's representative. Signature on form is for verification

purposes only. Include the Design N-value calculation and resulting drilled pier length, “L,” on each form.

If non-standard site-specific poles are shown on the plans, submit completed boring logs collected in accordance with Section 2 (Soil Test) along with pole loading diagrams from the plans to the Contractor-selected pole Fabricator to assist in the pole and foundation design.

If one of the following occurs, the Standard Foundations Chart shown on the plans may not be used and a non-standard foundation may be required. In such case, contact the Engineer.

- The Design N-value is less than four (4).
- The drilled pier length, “L”, determined from the Standard Foundations Chart, is greater than the depth of the corresponding boring.

In the case where a standard foundation cannot be used, the Department will be responsible for the additional cost of the non-standard foundation.

Foundation designs are based on level ground around the traffic signal pole. If the slope around the edge of the drilled pier is steeper than 8:1 (H:V) or the proposed foundation will be less than 10 feet from the top of an embankment slope, the Contractor is responsible for providing slope information to the foundation Designer and to the Engineer so it can be considered in the design.

The “Metal Pole Standard Foundation Selection Form” may be found at:

<https://connect.ncdot.gov/resources/safety/Pages/ITS-Design-Resources.aspx>

If assistance is needed, contact the Engineer.

#### **4. Non-Standard Foundation Design:**

Design non-standard foundations based upon site-specific soil test information collected in accordance with Section 2 (Soil Test). Design drilled piers for side resistance in accordance with Section 4.6 of the *2002 AASHTO Standard Specifications for Highway Bridges, 17<sup>th</sup> Edition*. Use computer software LPILE version-6.0 or later manufactured by Ensoft, Inc. to analyze drilled piers. Use computer software gINT V8i or later manufactured by Bentley Systems, Inc. with the current NCDOT gINT library and data template to produce SPT boring logs. Provide a drilled pier foundation for each pole with a length and diameter resulting in horizontal lateral movement less than 1 inch at top of the pier, and horizontal rotational movement less than 1 inch at the edge of pier. Contact the Engineer for pole loading diagrams of standard poles used for non-standard foundation designs. Submit non-standard foundation designs including drawings, calculations, and soil boring logs to the Engineer for review and approval, before construction.

#### **C. Drilled Pier Construction:**

Construct drilled pier foundation and Install anchor rod assemblies in accordance with the *Foundations and Anchor Rod Assemblies for Metal Poles* Standard Special Provision SP09-R005 located at:

<https://connect.ncdot.gov/resources/Specifications/Pages/2018-Specifications-and-Special-Provisions.aspx>

### **6.3. METAL POLE REMOVALS**

#### **A. Description:**

Remove and dispose of existing metal support poles, and remove and dispose of existing foundations, associated anchor bolts, electrical wires and connections.

**B. Construction Methods:**

**1. Foundations:**

Remove and promptly dispose of the metal support pole foundations including reinforcing steel, electrical wires, and anchor bolts to a minimum depth of 2 feet below the finished ground elevation. At the Contractor’s option, remove the complete foundation.

**2. Metal Poles:**

Consult Division Traffic Services regarding ownership of poles. If the Division chooses to maintain these structures in their inventory for future use, permanently mark the pole with the signal inventory number, asset inventory number or some identifying information that identifies where the pole came from

Remove the metal support poles, and promptly transport the metal support poles from the project. Use methods to remove the metal support poles and attached equipment that will not result in damage to other portions of the project or facility. Repair damages that are a result of the Contractor's actions at no additional cost to the Department.

Transport and properly dispose of the materials.

Backfill and compact disturbed areas to match the finished ground elevation. Seed unpaved areas.

Use methods to remove the foundations that will not result in damage to other portions of the project or facility. Repair damages that are a result of the Contractor's actions at no cost to the Department.

**6.4. POLE NUMBERING SYSTEM**

Attach an identification tag to each pole shaft section as shown on Metal Pole Standard Sheet M2 “Typical Fabrication Details for All Metal Poles.”

**6.5. MEASUREMENT AND PAYMENT**

Actual number of metal strain signal poles (without regard to height or load capacity) furnished, installed and accepted.

Actual number of metal signal pole foundations removed and disposed.

Actual number of metal signal poles removed and disposed.

Actual number of soil tests with SPT borings drilled furnished and accepted.

Actual volume of concrete poured in cubic yards of drilled pier foundation furnished, installed and accepted.

No measurement will be made for foundation designs prepared with metal pole designs, as these will be considered incidental to designing Traffic Signal or CCTV support structures.

**Payment will be made under:**

Metal Strain Signal Pole .....	Each
Metal Pole Foundation Removal .....	Each
Metal Pole Removal.....	Each
Soil Test .....	Each
Drilled Pier Foundation.....	Cubic Yard



## 7. JUNCTION BOX MARKERS

### 7.1. DESCRIPTION

Furnish and install junction box markers with all necessary hardware and adhesives to warn of buried fiber-optic communications cable.

### 7.2. MATERIALS

#### A. Junction Box Markers

Furnish durable, non-reflective junction box markers, also known as curb markers, fabricated from UV-resistant, non-metallic materials other than ceramic material, such as polyurethane or high impact polypropylene or other high impact plastic. Provide junction box markers that are designed for outdoor use, that are waterproof, that resist fading, that are temperature stable and that resist chemical and mechanical abrasion. Furnish junction box markers with a quick-setting adhesive designed for use with the junction box markers supplied and designed to permanently adhere junction box markers to Portland cement/concrete, steel, and cast iron as well as other non-porous hard surfaces. Do not provide markers that require intrusive fasteners to secure the marker to the surface. Do not provide adhesives that are not designed for use with the junction markers supplied. Provide junction box markers that do not require special tools such as torches, tamping machines or drills or hardware or special surface preparation for installation. Furnish junction box markers from a manufacturer that has been producing such junction box markers (i.e., curb markers) for a minimum of 10 consecutive years.

Order the junction box marker with the Division's Phone Number printed on the marker, hand written sharpie labeling is not acceptable. Consult with the Engineer to ensure the junction box labels are ordered with the correct Division phone number. Provide junction box markers that contain the text and symbols, text emphasis and text proportions depicted in the example format shown below.:

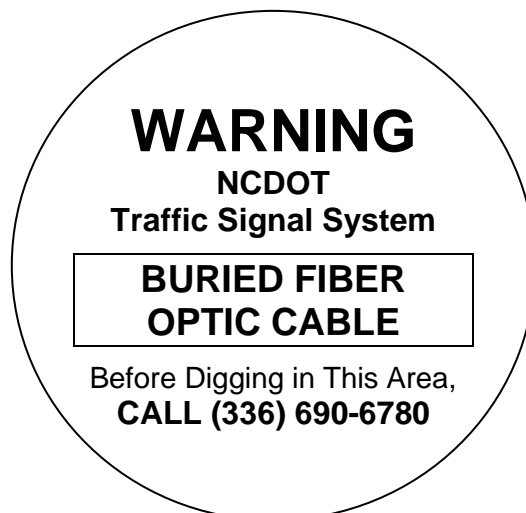

Overall Junction Box Marker Dimensions: 2.5" diameter

Text: Black

Background: Light Gray (to blend with concrete and granite surfaces)

Submit samples of proposed junction marker to the Engineer for approval before installation. In lieu of designing a custom junction box marker, the Contractor may submit for the Engineer’s approval a stock/standard junction box marker format (i.e., off-the-shelf format) from the junction box marker manufacturer that differs from the example format proposed above but that still embodies the content and intent conveyed by the example format.

Have the junction box marker manufacturer provide a list of references along with contract information for at least five different municipal government agencies and/or state departments of transportation that have installed the proposed manufacturer’s markers and can attest to the performance of the manufacturer’s markers over a continuous period of no less than seven years. Submit these references to the Engineer for review in conjunction with submission of the sample.

**7.3. CONSTRUCTION METHODS**

Apply junction box markers to the surface of the junction box cover/lid on all new and/or existing junction boxes that are to be reused to house the fiber-optic communications cable. Additionally, at locations where a junction box is perpendicular to a raised curb place an additional junction box marker on the curb.

Clean surface to which the junction box marker will be applied. Make sure application surface is dry and free of any loose debris or cracks. Apply adhesive to back side of the junction box marker in accordance with manufacturer’s instructions. Apply additional adhesive when surface is uneven or textured to fill voids and assure secure adhesion. Apply the junction box marker to the application surface and press firmly. Ensure that entire edge around perimeter of marker is sealed to the application surface.

Position the marker in the approximate center of the junction box cover and orient the marker so that its text is parallel to long side of the cover. On curb sections install the marker on the flattest surface of the curb at a point that is perpendicular to the junction box.

Junction box markers are not required to be place on flat surfaces of the roadway where there is no curbing, unless required by the Engineer.

**7.4. MEASUREMENT AND PAYMENT**

*Junction Box Marker* will be measured and paid for as the actual number of junction box markers furnished, installed, and accepted.

No measurement will be made of junction box marker adhesive as this will be considered incidental to furnishing and installing the junction box marker.

Payment will be made under:

Junction Box Marker.....Each

**8. BACK PULL FIBER OPTIC CABLE**

**8.1. DESCRIPTION**

Back pull and store or back pull and reinstall existing communications cable.

**8.2. CONSTRUCTION**

During project construction where instructed to back pull existing aerial sections of fiber optic communications cable, de-lash the cable from the messenger cable and back pull the cable to a point

where it can be stored or re-routed as shown on the plans. If instructed, remove and discard the existing messenger cable and pole mounting hardware once the cable is safely out of harm’s way.

During project construction where instructed to back pull existing underground sections of fiber optic communications cable, back pull the cable to a point where it can be stored or re-routed as shown on the plans. If instructed, remove abandoned junction boxes and backfill with a suitable material to match the existing grade. Leave abandoned conduits in place unless otherwise noted.

Where instructed, re-pull the fiber optic cable back along messenger cable or through conduit systems.

**8.3. MEASUREMENT AND PAYMENT**

*Back Pull Fiber Optic Cable* will be paid for as the actual linear feet of fiber optic cable back pulled and either stored or back pulled and rerouted. Payment is for the actual linear feet of cable back pulled.

No payment will be made for removing messenger cable and pole mounting hardware or removing junction boxes and back filling to match the surrounding grade as these items of work will be considered incidental to back pulling the fiber optic cable.

Payment will be made under:

Back Pull Fiber Optic Cable ..... Linear Feet

**9. ETHERNET EDGE SWITCH**

Furnish and install a managed Ethernet edge switch as specified below that is fully compatible, interoperable, and completely interchangeable and functional within the existing City or Division traffic signal system communications network.

**9.1. DESCRIPTION**

**A. Ethernet Edge Switch:**

Furnish and install a hardened, field Ethernet edge switch (hereafter “edge switch”) for traffic signal controllers as specified below. Ensure that the edge switch provides wire-speed, fast Ethernet connectivity at transmission rates of 100 megabits per second from each remote ITS device location to the routing switches.

Contact the City or Division to arrange for the programming of the new Field Ethernet Switches with the necessary network configuration data, including but not limited to, the Project IP Address, Default Gateway, Subnet Mask and VLAN ID information. Provide a minimum five (5) days working notice to allow the City or Division to program the new devices.

**B. Network Management:**

Ensure that the edge switch is fully compatible with the City’s or Division’s existing Network Management Software.

**9.2. MATERIALS**

**A. General:**

Ensure that the edge switch is fully compatible and interoperable with the trunk Ethernet network interface and that the edge switch supports half and full duplex Ethernet communications.

Furnish an edge switch that provide 99.999% error-free operation, and that complies with the Electronic Industries Alliance (EIA) Ethernet data communication requirements using single-mode

fiber-optic transmission medium and copper transmission medium. Ensure that the edge switch has a minimum mean time between failures (MTBF) of 10 years, or 87,600 hours, as calculated using the Bellcore/Telcordia SR-332 standard for reliability prediction.

### **B. Compatibility Acceptance**

The Engineer has the authority to require the Contractor to submit a sample Field Ethernet Switch and Field Ethernet Transceiver along with all supporting documentation, software and testing procedures to allow a compatibility acceptance test be performed prior to approving the proposed Field Ethernet Switch and Field Ethernet Transceiver for deployment. **The Compatibility Acceptance testing will ensure that the proposed device is 100% compatible and interoperable with the existing City Signal System network, monitoring software and Traffic Operations Center network hardware.** Allow fifteen (15) working days for the Compatibility Acceptance Testing to be performed

### **C. Standards:**

Ensure that the edge switch complies with all applicable IEEE networking standards for Ethernet communications, including but not limited to:

- IEEE 802.1D standard for media access control (MAC) bridges used with the Spanning Tree Protocol (STP);
- IEEE 802.1Q standard for port-based virtual local area networks (VLANs);
- IEEE 802.1P standard for Quality of Service (QoS);
- IEEE 802.1w standard for MAC bridges used with the Rapid Spanning Tree Protocol (RSTP);
- IEEE 802.1s standard for MAC bridges used with the Multiple Spanning Tree Protocol;
- IEEE 802.1x standard for port based network access control, including RADIUS;
- IEEE 802.3 standard for local area network (LAN) and metropolitan area network (MAN) access and physical layer specifications;
- IEEE 802.3u supplement standard regarding 100 Base TX/100 Base FX;
- IEEE 802.3x standard regarding flow control with full duplex operation; and
- IFC 2236 regarding IGMP v2 compliance.
- IEEE 802.1AB Link Layer Discovery Protocol (LLDP)
- IEEE 802.3ad Ethernet Link Aggregation
- IEEE 802.3i for 10BASE-T (10 Mbit/s over Fiber-Optic)
- IEEE 802.3ab for 1000BASE-T (1Gbit/s over Ethernet)
- IEEE 802.3z for 1000BASE-X (1 Gbit/s Ethernet over Fiber-Optic)

### **D. Functional:**

Ensure that the edge switch supports all Layer 2 management features and certain Layer 3 features related to multicast data transmission and routing. These features shall include, but not be limited to:

- An STP healing/convergence rate that meets or exceeds specifications published in the IEEE 802.1D standard.
- An RSTP healing/convergence rate that meets or exceeds specifications published in the IEEE 802.1w standard.

- An Ethernet edge switch that is a port-based VLAN and supports VLAN tagging that meets or exceeds specifications as published in the IEEE 802.1Q standard, and has a minimum 4-kilobit VLAN address table (254 simultaneous).
- A forwarding/filtering rate that is a minimum of 14,880 packets per second for 10 megabits per second and 148,800 packets per second for 100 megabits per second.
- A minimum 4-kilobit MAC address table.
- Support of Traffic Class Expediting and Dynamic Multicast Filtering.
- Support of, at a minimum, snooping of Version 2 & 3 of the Internet Group Management Protocol (IGMP).
- Support of remote and local setup and management via telnet or secure Web-based GUI and command line interfaces.
- Support of the Simple Network Management Protocol version 3 (SNMPv3). Verify that the Ethernet edge switch can be accessed using the resident EIA-232 management port, a telecommunication network, or the Trivial File Transfer Protocol (TFTP).
- Port security through controlling access by the users. Ensure that the Ethernet edge switch has the capability to generate an alarm and shut down ports when an unauthorized user accesses the network.
- Support of remote monitoring (RMON-1 & RMON-2) of the Ethernet agent.
- Support of the TFTP and SNTP. Ensure that the Ethernet edge switch supports port mirroring for troubleshooting purposes when combined with a network analyzer.

#### **E. Physical Features:**

*Ports:* Provide 10/100/1000 Mbps auto-negotiating ports (RJ-45) copper Fast Ethernet ports for all edge switches. Provide auto-negotiation circuitry that will automatically negotiate the highest possible data rate and duplex operation possible with attached devices supporting the IEEE 802.3 Clause 28 auto-negotiation standard.

*Optical Ports:* Ensure that all fiber-optic link ports operate at 1310 or 1550 nanometers in single mode. Provide Type LC connectors for the optical ports, as specified in the Plans or by the Engineer. Do not use mechanical transfer registered jack (MTRJ) type connectors.

Provide an edge switch having a minimum of two optical 100/1000 Base X ports capable of transmitting data at 100/1000 megabits per second. Ensure that each optical port consists of a pair of fibers; one fiber will transmit (TX) data and one fiber will receive (RX) data. Ensure that the optical ports have an optical power budget of at least 15 dB.

*Copper Ports:* Provide an edge switch that includes a minimum of four copper ports. Provide Type RJ-45 copper ports and that auto-negotiate speed (i.e., 10/100/1000 Base) and duplex (i.e., full or half). Ensure that all 10/100/1000 Base TX ports meet the specifications detailed in this section and are compliant with the IEEE 802.3 standard pinouts. Ensure that all Category 5E unshielded twisted pair/shielded twisted pair network cables are compliant with the EIA/TIA-568-B standard.

*Port Security:* Ensure that the edge switch supports/complies with the following (remotely) minimum requirements:

- Ability to configure static MAC addresses access;
- Ability to disable automatic address learning per ports; know hereafter as Secure Port. Secure Ports only forward; and

- Trap and alarm upon any unauthorized MAC address and shutdown for programmable duration. Port shutdown requires administrator to manually reset the port before communications are allowed.

#### F. Management Capabilities:

Ensure that the edge switch supports all Layer 2 management features and certain Layer 3 features related to multicast data transmission and routing. These features shall include, but not be limited to:

- An STP healing/convergence rate that meets or exceeds specifications published in the IEEE 802.1 D standards;
- An RSTP healing/convergence rate that meets or exceeds specifications published in the IEEE 802.1w standard;
- An Ethernet edge switch that is a port-based VLAN and supports VLAN tagging that meets or exceeds specifications as published in the IEEE 802.1Q standard, and has a minimum 4-kilobit VLAN address table (254 simultaneous);
- A forwarding/filtering rate that is a minimum of 14,880 packets per second for 10 megabits per second, 148,800 packets per second for 100 megabits per second and 1,488,000 packets per second for 1000 megabits per second;
- A minimum 4-kilobit MAC address table;
- Support of Traffic Class Expediting and Dynamic Multicast Filtering.
- Support of, at a minimum, snooping of Version 2 & 3 of the Internet Group Management Protocol (IGMP);
- Support of remote and local setup and management via telnet or secure Web-based GUI and command line interfaces; and
- Support of the Simple Network Management Protocol (SNMP). Verify that the Ethernet edge switch can be accessed using the resident EIA-232 management port, a telecommunication network, or the Trivial File Transfer Protocol (TFTP).

*Network Capabilities:* Provide an edge switch that supports/complies with the following minimum requirements:

- Provide full implementation of IGMPv2 snooping (RFC 2236);
- Provide full implementation of SNMPv1, SNMPv2c, and/or SNMPv3;
- Provide support for the following RMON–I groups, at a minimum:
  - Part 1: Statistics
  - Part 2: History
  - Part 3: Alarm
  - Part 9: Event
- Provide support for the following RMON–2 groups, at a minimum:
  - Part 13: Address Map
  - Part 16: Layer Host
  - Part 17: Layer Matrix
  - Part 18: User History
- Capable of mirroring any port to any other port within the switch;
- Meet the IEEE 802.1Q (VLAN) standard per port for up to four VLANs;
- Meet the IEEE 802.3ad (Port Trunking) standard for a minimum of two groups of four ports;
- Password manageable;
- Telnet/CLI;

- HTTP (Embedded Web Server) with Secure Sockets Layer (SSL); and
- Full implementation of RFC 783 (TFTP) to allow remote firmware upgrades.

*Network Security:* Provide an edge switch that supports/complies with the following (remotely) minimum network security requirements:

- Multi-level user passwords;
- RADIUS centralized password management (IEEE 802.1X);
- SNMPv3 encrypted authentication and access security;
- Port security through controlling access by the users: ensure that the Ethernet edge switch has the capability to generate an alarm and shut down ports when an unauthorized user accesses the network;
- Support of remote monitoring (RMON-1&2) of the Ethernet agent; and
- Support of the TFTP and SNTP. Ensure that the Ethernet edge switch supports port mirroring for troubleshooting purposes when combined with a network analyzer.

### **G. Electrical Specifications:**

Ensure that the edge switch operates and power is supplied with 115 volts of alternating current (VAC). Ensure that the edge switch has a minimum operating input of 110 VAC and a maximum operating input of 130 VAC. Ensure that if the device requires operating voltages other than 120 VAC, supply the required voltage converter. Ensure that the maximum power consumption does not exceed 50 watts. Ensure that the edge switch has diagnostic light emitting diodes (LEDs), including link, TX, RX, speed (for Category 5E ports only), and power LEDs.

### **H. Environmental Specifications:**

Ensure that the edge switch performs all of the required functions during and after being subjected to an ambient operating temperature range of -30 degrees to 165 degrees Fahrenheit as defined in the environmental requirements section of the NEMA TS 2 standard, with a noncondensing humidity of 0 to 95%.

Provide certification that the device has successfully completed environmental testing as defined in the environmental requirements section of the NEMA TS 2 standard. Provide certification that the device meets the vibration and shock resistance requirements of Sections 2.1.9 and 2.1.10, respectively, of the NEMA TS 2 standard. Ensure that the edge switch is protected from rain, dust, corrosive elements, and typical conditions found in a roadside environment.

The edge switch shall meet or exceed the following environmental standards:

- IEEE 1613 (electric utility substations)
- IEC 61850-3 (electric utility substations)
- IEEE 61800-3 (variable speed drive systems)
- IEC 61000-6-2 (generic industrial)
- EMF – FCC Part 15 CISPR (EN5502) Class A

### **I. Ethernet Patch Cable:**

Furnish a factory pre-terminated/pre-connectorized Ethernet patch cable with each edge switch. Furnish Ethernet patch cables meeting the following physical requirements:

- Five (5)-foot length
- Category 5e or better

- Factory-installed RJ-45 connectors on both ends
- Molded anti-s snag hoods over connectors
- Gold plated connectors

Furnish Fast Ethernet patch cords meeting the following minimum performance requirements:

- TIA/EIA-568-B-5, Additional Transmission Performance Specifications for 4-pair 100 Ω Enhanced Category 5 Cabling
- Frequency Range: 1-100 MHz
- Near-End Crosstalk (NEXT): 30.1 dB
- Power-sum NEXT: 27.1 dB
- Attenuation to Crosstalk Ratio (ACR): 6.1 dB
- Power-sum ACR: 3.1 dB
- Return Loss: 10dB
- Propagation Delay: 548 nsec

**9.3. CONSTRUCTION METHODS**

**A. General:**

Ensure that the edge switch is UL listed.

Verify that network/field/data patch cords meet all ANSI/EIA/TIA requirements for Category 5E and Category 6 four-pair unshielded twisted pair cabling with stranded conductors and RJ45 connectors.

Contact the Signal Shop a minimum of 5 days prior to installation for the most current edge switch IP Address, VLAN, subnet mask, default gateway and configuration files.

**B. Edge Switch:**

Mount the edge switch inside each field cabinet by securely fastening the edge switch to the upper end of the right rear vertical rail of the equipment rack using manufacturer-recommended or Engineer-approved attachment methods, attachment hardware and fasteners.

Ensure that the edge switch is mounted securely in the cabinet and is fully accessible by field technicians without blocking access to other equipment. Verify that fiber-optic jumpers consist of a length of cable that has connectors on both ends, primarily used for interconnecting termination or patching facilities and/or equipment.

**9.4. MEASUREMENT AND PAYMENT**

*Ethernet edge switch* will be measured and paid as the actual number of Ethernet edge switches furnished, installed, and accepted.

No separate measurement will be made for Ethernet patch cable, power cord, mounting hardware, nuts, bolts, brackets, or edge switch programming as these will be considered incidental to furnishing and installing the edge switch.

Payment will be made under:

Ethernet Edge Switch.....Each



## 10. MODIFY SPREAD SPECTRUM WIRELESS RADIO

### 10.1. DESCRIPTION

Make modifications to existing Spread Spectrum Radio installations.

### 10.2. MATERIALS

Material, equipment, and hardware furnished under this section shall be pre-approved on the Departments' QPL.

Reference Article 1098-18 "Spread Spectrum Wireless Radio" of the Standard Specifications for Roads and Structures.

### 10.3. CONSTRUCTION METHODS

This item of work involves making modifications to existing wireless installations which include relocating an existing radio from an existing cabinet to a new cabinet, and/or relocating existing components of the radio system from an existing pole to new poles (wood poles, metal strain poles, metal poles with mast arms, etc.). This item of work includes, but may not be limited to, the following:

- Relocating existing radio from an existing cabinet to a new cabinet
- Relocating or installing new Coaxial Cable
- Furnishing and installing new N-Type Connectors
- Furnishing new Coaxial Cable and Shield Grounding Kits
- Relocating Antenna Mounting Hardware
- Relocating Antennas

This item of work may also involve converting an existing standalone radio site to a repeater site, or replacing the existing radio antenna with a different type as specified on the plan (e.g. Yagi vs. Omni direction). This item of work includes, but may not be limited to, the following:

- Furnishing and installing new antenna(s)
- Furnishing and installing new antenna mounting hardware kits
- Furnishing and installing new 6 foot coaxial cable jumpers with N-Type Connectors
- Furnishing and installing new coaxial cable – power divider (Splitters)

### 10.4. MEASUREMENT AND PAYMENT

*Modify Radio Installation* will be measured as the actual number of modified radio installations that are modified and accepted.

This item includes relocating the radio, and furnishing and/or relocating and installing coaxial cable, N-Type Connectors, coaxial cable shield grounding kits, antenna mounting hardware, antennas, coaxial cable and power dividers. This item of work may also involve furnishing and installing new decals and furnishing or relocating signs. This item of work may also involve re-programming the radio.

Payment for new risers will be covered separately.

Payment will be made under:

Modify Radio Installation.....Each

**11. REMOVE SPREAD SPECTRUM WIRELESS RADIO**

**11.1. DESCRIPTION**

Remove the existing Spread Spectrum Radio installations.

**11.2. CONSTRUCTION METHODS**

Remove the existing wireless installations as shown on plans. This item of work includes the removal of the radio antennas, the mounting hardware, and the power/communication cables from the antennas to the signal cabinets.

**11.3. MEASUREMENT AND PAYMENT**

*Remove Radio Installation* will be measured as the actual number of modified radio installations removed.

Payment will be made under:

Remove Radio Installation.....Each

**12. GPS EMERGENCY VEHICLE PREEMPTION SYSTEM RELOCATION**

**12.1. DESCRIPTION**

Relocate existing GPS-enabled Emergency Vehicle Preemption (GPS EVP) system intersection equipment from an existing cabinet to a new cabinet.

**12.2. MATERIALS**

Material, equipment, hardware and software furnished under this section shall be pre-approved on the Departments' QPL. The GPS EVP Intersection Equipment shall include the GPS Radio unit, phase selector, GPS Card Rack, the installation cables, mounting hardware, system software, and any additional components as needed to provide the EVP signal operations as shown on signal plans.

**12.3. CONSTRUCTION METHODS**

This item of work includes, but may not be limited to, the following:

Relocating existing GPS EVP Intersection Equipment from an existing cabinet to a new cabinet, and programing the GPS EVP system to provide the EVP signal operations as shown on signal plans.

All work shall be completed in accordance of the Manufacturer's instructions.

**12.4. MEASUREMENT AND PAYMENT**

There will be no direct payment for relocating the existing GPS EVP system. Replacement cables, mounting hardware, and GPS EVP system configuration programing, setup, and testing will be considered incidental. Payment at the contract unit prices for the various items in the contract will be full compensation form all work covered by this section.

# BP-1

Project I-5711

Alamance County

## Project Special Provisions Structure

### Table of Contents

	Page #
Maintenance and Protection of Traffic Beneath Proposed Structure at Station 27+02.26-L-	(8-13-04) .....BP-2
Epoxy Resin Injection	(2-11-19) .....BP-3
Electrical Conduit System for Signals	(9-30-11) .....BP-7
Shotcrete Repairs	(2-11-19) .....BP-11
Steel Reinforced Elastomeric Bearings	(6-22-16) .....BP-16
Concrete Repairs	(2-11-19) .....BP-17
Thermal Sprayed Coatings (Metallization)	(12-1-17) .....BP-20
Falsework and Formwork	(4-5-12) .....BP-22
Submittal of Working Drawings	(6-28-17) .....BP-28
Crane Safety	(6-20-19) .....BP-34
Grout for Structures	(12-1-17) .....BP-35
Bridge Mounted Chain Link Fence	(SPECIAL).....BP-36
Foam Joint Seals	(SPECIAL).....BP-37
Epoxy Coating	(SPECIAL).....BP-41
Overlay Surface Preparation for Polyester Polymer Concrete	(SPECIAL).....BP-42
Polyester Polymer Concrete Bridge Deck Overlay	(SPECIAL).....BP-48

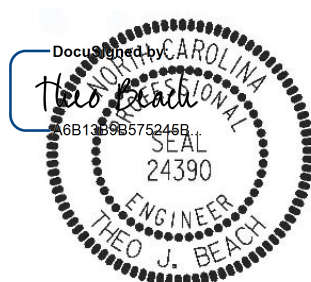

12/21/2020

## **BP-2**

Project I-5711

Alamance County

### **MAINTENANCE AND PROTECTION OF TRAFFIC BENEATH PROPOSED STRUCTURE AT STATION 27+02.26-L-**

**(8-13-04)**

#### **1.0 GENERAL**

Maintain traffic on I-40/I-85 as shown in Traffic Control Plans and as directed by the Engineer.

Provide a minimum temporary vertical clearance of 16'-0" at all times during construction.

Submit plans and calculations for review and approval for protecting traffic and bracing girders, as described herein, at the above station before beginning work at this location. Have the drawings and design calculations prepared, signed, and sealed by a North Carolina Registered Professional Engineer. The approval of the Engineer will not relieve the Contractor of the responsibility for the safety of the method or equipment.

#### **2.0 PROTECTION OF TRAFFIC**

Protect traffic from any operation that affords the opportunity for construction materials, equipment, tools, etc. to be dropped into the path of traffic beneath the structure. Based on Contractor means and methods determine and clearly define all dead and live loads for this system, which, at a minimum, shall be installed between beams or girders over any travel way or shoulder area where traffic is maintained. Install the protective system before beginning any construction operations over traffic. In addition, for these same areas, keep the overhang falsework in place until after the rails have been poured.

#### **3.0 BRACING GIRDERS**

Brace girders to resist wind forces, weight of forms and other temporary loads, especially those eccentric to the vertical axis of the member during all stages of erection and construction. Before casting of intermediate diaphragms, decks, or connecting steel diaphragms do not allow the horizontal movement of girders to exceed 1/2 inch.

#### **4.0 BASIS OF PAYMENT**

Payment at the contract unit prices for the various pay items will be full compensation for the above work.

**BP-3**

Project I-5711

Alamance County

**EPOXY RESIN INJECTION****(2-11-19)****GENERAL**

For repairing cracks, an applicator certified by the manufacturer of epoxy injection system to be used is required to perform the epoxy resin injection. The Contractor shall submit documentation that indicates the firm, supervisor and the workmen have completed an instruction program in the methods of restoring concrete structures utilizing the epoxy injection process and have five (5) years of relative experience with a record of satisfactory performance on similar projects.

The Contractor furnishes all materials, tools, equipment, appliances, labor and supervision required when repairing cracks with the injection of an epoxy resin adhesive.

**SCOPE OF WORK**

Using Epoxy Resin Injection, repair all cracks 5 mils (125  $\mu\text{m}$ ) wide or greater in the end bent caps and backwall, interior bent columns and concrete median barrier

**COOPERATION**

Cooperate and coordinate with the Technical Representative of the epoxy resin manufacturer for satisfactory performance of the work.

Have the Technical Representative present when the job begins and until the Engineer is assured that his service is no longer needed.

The expense of having this representative on the job is the Contractor's responsibility and no direct payment will be made for this expense.

**TESTING**

The North Carolina Department of Transportation Materials and Tests Unit will obtain cores from the repaired concrete for testing. If the failure plane is located at the repaired crack, a minimum compressive strength of 3,000 psi is required of these cores.

**MATERIAL PROPERTIES**

Provide a two-component structural epoxy adhesive for injection into cracks or other voids. Provide modified epoxy resin (Component "A") that conforms to the following requirements:

	Test Method	Specification Requirements
Viscosity @ 40 $\pm$ 3°F, cps	Brookfield RVT Spindle No. 4 @ 20 rpm	6,000 – 8,000
Viscosity @ 77 $\pm$ 3°F, cps	Brookfield RVT Spindle No. 2 @ 20 rpm	400 - 700
Epoxy Equivalent Weight	ASTM D1652	152 - 168

**BP-4**

Project I-5711

Alamance County

Ash Content, %	ASTM D482	1 max.
----------------	-----------	--------

Provide the amine curing agent (Component "B") used with the epoxy resin that meets the following requirements:

	Test Method	Specification Requirements
Viscosity @ 40 ± 3°F, cps	Brookfield RVT Spindle No. 2 @ 20 rpm	700 - 1400
Viscosity @ 77 ± 3°F, cps	Brookfield RVT Spindle No. 2 @ 20 rpm	105 - 240
Amine Value, mg KOH/g	ASTM D664*	490 - 560
Ash Content, %	ASTM D482	1 max.
* Method modified to use perchloric acid in acetic acid.		

Certify that the Uncured Adhesive, when mixed in the mix ratio that the material supplier specifies, has the following properties:

- Pot Life (60 gram mass)
  - @ 77 ± 3°F - 15 minutes minimum
  - @ 100 ± 3°F - 5 minutes minimum

Certify that the Adhesive, when cured for seven (7) days at 77 ± 3°F unless otherwise specified, has the following properties:

	Test Method	Specification Requirements
Ultimate Tensile Strength	ASTM D638	7,000 psi (min.)
Tensile Elongation at Break	ASTM D638	4% max.
Flexural Strength	ASTM D790	10,000 psi (min.)
Flexural Modulus	ASTM D790	3.5 x 10 <sup>5</sup> psi
Compressive Yield Strength	ASTM D695	11,000 psi (min.)
Compressive Modulus	ASTM D695	2.0 - 3.5 x 10 <sup>5</sup> psi
Heat Deflection Temperature Cured 28 days @ 77 ± 3°F	ASTM D648*	125°F min. 135°F min.
Slant Shear Strength, 5,000 psi (34.5 MPa) compressive strength concrete Cured 3 days @ 40°F wet concrete Cured 7 days @ 40°F wet concrete Cured 1 day @ 77°F dry concrete	AASHTO T237	3,500 psi (min.) 4,000 psi (min.) 5,000 psi (min.)
* Cure test specimens so the peak exothermic temperature does not exceed 77°F.		

Use an epoxy bonding agent, as specified for epoxy mortar, as the surface seal (used to confine the epoxy resin during injection).

## **BP-5**

Project I-5711

Alamance County

### **EQUIPMENT FOR INJECTION**

Use portable positive displacement type pumps with interlock to provide positive ratio control of exact proportions of the two (2) components at the nozzle to meter and mix the two (2) injection adhesive components and inject the mixed adhesive into the crack. Use electric or air powered pumps that provide in-line metering and mixing.

Use injection equipment with automatic pressure control capable of discharging the mixed adhesive at any pre-set pressure up to  $200 \pm 5$  psi and equipped with a manual pressure control override.

Use equipment capable of maintaining the volume ratio for the injection adhesive as prescribed by the manufacturer. A tolerance of  $\pm 5\%$  by volume at any discharge pressure up to 200 psi is permitted.

Provide injection equipment with sensors on both the Component A and B reservoirs that automatically stop the machine when only one component is being pumped to the mixing head.

### **PREPARATION**

Follow these steps prior to injecting the epoxy resin:

- (A) Remove all dirt, dust, grease, oil, efflorescence and other foreign matter detrimental to the bond of the epoxy injection surface seal system from the surfaces adjacent to the cracks or other areas of application. Acids and corrosives are not permitted.
- (B) Provide entry ports along the crack at intervals not less than the thickness of the concrete at that location, unless otherwise directed by the Engineer.
- (C) Apply surface seal material to the face of the crack between the entry ports. For through cracks, apply surface seal to both faces.
- (D) Allow enough time for the surface seal material to gain adequate strength before proceeding with the injection.

### **EPOXY INJECTION**

Before epoxy adhesive injection occurs, the Contractor shall test discharge one pint of epoxy to calibrate the equipment and to demonstrate that the workmen and equipment are working properly.

Begin epoxy adhesive injection in vertical cracks at the lower entry port and continue until the epoxy adhesive appears at the next higher entry port adjacent to the entry port being pumped.

Begin epoxy adhesive injection in horizontal cracks at one end of the crack and continue as long as the injection equipment meter indicates adhesive is being dispensed or until adhesive shows at the next entry port.

## **BP-6**

Project I-5711

Alamance County

When epoxy adhesive appears at the next adjacent port, stop the current injection and transfer the epoxy injection to the next adjacent port where epoxy adhesive appeared.

Perform epoxy adhesive injection continuously until cracks are completely filled. Any stoppage of injection for more than 15 minutes shall result in the injection equipment being cleaned, at no additional cost to the Department, before resuming injection.

If port to port travel of epoxy adhesive is not indicated, immediately stop the work and notify the Engineer.

### **FINISHING**

When cracks are completely filled, allow the epoxy adhesive to cure for sufficient time to allow the removal of the surface seal without any draining or runback of epoxy material from the cracks.

Drill 4" diameter cored holes of the cured epoxy to the full depth of the crack to verify the cracks has been completely filled with epoxy. Three (3) cored holes are required for every 100 linear feet of crack to be injected, or as directed by the Engineer. The cored holes will be filled with Type 3 grout in accordance with Section 1003 of the *Standard Specifications*.

Remove the surface seal material and injection adhesive runs or spills from concrete surfaces.

Finish the face of the crack flush to the adjacent concrete, removing any indentations or protrusions caused by the placement of entry ports.

### **BASIS OF PAYMENT**

*Epoxy Resin Injection* will be paid at the contract unit price per linear foot. Such payment will be full compensation for all materials, tools, equipment, labor, and for all incidentals necessary to complete the work.

#### **Pay Item**

#### **Pay Unit**

Epoxy Resin Injection

Linear Foot



## **BP-7**

Project I-5711

Alamance County

### **ELECTRICAL CONDUIT SYSTEM FOR SIGNALS**

**(9-30-11)**

#### **1.0 GENERAL**

The work covered by this section consists of furnishing and installing a conduit system suspended beneath structures and buried. Perform all work in accordance with these special provisions, the plans, and the National Electrical Code (NEC). Install the conduit system in accordance with NEC requirements as an approved raceway for electrical circuits.

The Contractor actually performing the work described in these special provisions is required to have a license of the proper classification from the North Carolina State Board of Examiners of Electrical Contractors.

The licensed Electrical Contractor is required to be available on the job site when the work is being performed or when requested by the Engineer. The licensed Electrical Contractor is required to have a set of plans and special provisions in his possession on the job site, and must maintain accurate "as built" plans.

#### **2.0 MATERIALS**

Submit eight (8) copies of catalog cuts and/or drawings for all proposed materials for the Engineer's review and approval. Include the brand name, stock number, description, size, rating, manufacturing specification, and applicable contract item number(s) on each submittal. Allow forty (40) days for submittal review. The Engineer will advise the Contractor of reasons for rejected submittals and will return approved submittals to the Contractor. Do not deliver material to the project prior to submittal approval.

For the work covered by this section, the term conduit applies to a system of components consisting of an outer duct, 4 inner ducts, internal spacers, special-purpose spin couplings and all necessary components, referred to as a multi-cell raceway system.

For the outer duct of RGC multi-cell raceway, use rigid galvanized conduit per UL 6 "Rigid Metallic Conduit" with rigid full weight galvanized threaded fittings. Provide factory installed reverse-spin couplings with 3 set screws, to allow assembly without turning the outer duct, and prevent the coupling from backing off before and after installation. Provide an O-ring gasket in the coupling body to resist pullout and to create a watertight seal. Provide pre-installed, smooth walled, pre-lubricated PVC inner ducts, with one white "tracer" duct and internal spacers to maintain alignment throughout the raceway system. Do not use materials provided by more than one manufacturer.

When deflection couplers are detailed on the plans, use deflection couplers that are designed for use with RGC multi-cell raceway, and meet all the requirements for RGC outer duct stated above. Provide deflection couplers that allow a 30 degree bend in any direction and 3/4 inch mis-alignment in all axis. Provide factory installed reverse-spin couplings with 3 set screws, to allow assembly without turning the outer duct, and prevent the coupling from backing off before and after installation. Provide deflection couplers

## BP-8

Project I-5711

Alamance County

with a middle section consisting of a rubber boot attached by spin couplings and galvanized straps, with inner ducts that bend in unison with the rubber boot.

Use expansion joints that are designed for use with RGC multi-cell raceway, and meet the requirements for RGC outer duct stated above. Provide expansion joints that allow 8 inches of longitudinal movement. Use expansion joints consisting of a female end with a lead-in coupling body and spin coupling, an exterior sliding joint, and a fixed inner duct with an internal sliding joint. Provide expansion joints that have factory installed reverse-spin couplings with 3 set screws, to allow assembly without turning the outer duct and prevent the coupling from backing off before and after installation.

Use transition adapters that allow RGC raceway and PVC raceway to be coupled together while maintaining the same inner duct alignment. Provide adapters consisting of a threaded female adapter, an outer duct adapter, and a modified coupling body with a sleeve, thin wall couplings and an end spacer.

For the outer duct of PVC multi-cell raceway use schedule 40 PVC per UL 651 "Rigid Nonmetallic Conduit." Use PVC raceway with 6 inch bell ends and an O-ring gasket to resist pullout and provide a watertight seal. Provide PVC raceway having a print line that states "Install Print Line Up" to help facilitate correct installation. Use PVC raceway with pre-lubricated PVC inner ducts, with one white "tracer" duct and internal spacers to maintain alignment throughout the raceway system. Do not use material provided by more than one manufacturer.

Use terminations designed for PVC raceway, to seal each inner duct and the outer duct, and to provide watertight protection.

Use schedule 40 PVC for sleeves in accordance with UL 651 "Rigid Nonmetallic Conduit."

Provide concrete inserts made of galvanized malleable iron, with internal threads for suspending loads from a fixed point beneath a concrete ceiling or deck where no lateral adjustment is required. Use inserts that can be secured to the concrete forms, preventing movement during concrete placement.

For stabilizers and hangers, use galvanized rods that conform to ASTM-A36 or A-575. Galvanized rods may be threaded on both ends or threaded continuously. Use steel stabilizer clamps and attachment brackets, sized as noted in the plans and hot dipped galvanized per ASTM-A123. Provide high strength bolts, nuts and washers that are galvanized in accordance with Article 1072-5 of the Standard Specifications.

Use adjustable clevis-type pipe hangers that allow for vertical adjustment and limited movement of the pipe. Use galvanized pipe hangers that are listed with Underwriters Laboratories, or are Factory Mutual approved for the size conduit shown in the plans. Use hangers that comply with Federal Specification WW-H-171E Type 1 and Manufacturers Standardization Society SP-69 Type 1. Plastic-coat the saddle area of the hanger.

## BP-9

Project I-5711

Alamance County

Provide pull lines specifically designed for pulling rope through conduit. Use pull lines made of 2-ply line, with a tensile strength of 240 pounds minimum. Use rot and mildew resistant pull lines that are resistant to tangling when being dispensed.

Use mastic that is a permanent, non-hardening, water sealing compound that adheres to metal, plastic, and concrete.

Provide jute that is a burlap-like material used for filling voids and protecting components from waterproofing and adhesive compounds.

Provide zinc rich paint conforming to Section 1080-9 of the Standard Specifications.

### 3.0 INSTALLATION

To ensure against corrosion in the area where hot dipped galvanizing has been damaged, cover all raw metal surfaces with a cold galvanized, zinc rich paint.

Stub the raceway out at an accessible location and seal with termination kits designed specifically for that purpose. Use termination kits of the same material as the raceway.

Install Stabilizers as shown on the plans to assure proper movement of the conduit expansion joints. Securely fasten the clamps with attachment brackets and stabilizer rods to the conduit at the indicated locations to assure these locations remain stationary. Install the stabilizer rods parallel to the alignment of the conduit, and tilt rod upward at an orientation of 45 degrees to the bottom of the bridge deck.

Insert a pull line in each inner duct with sufficient slack for future use.

Securely fasten all components to prevent movement during concrete placement.

Smooth all sleeve ends and make them flush with surrounding concrete surfaces. Remove burrs and rough edges by filing or grinding. A torch may be used to cut the ends of metal sleeves. Use shields to protect all surfaces during torch-cutting operations.

Place backfill in accordance with Section 300-7 of the Standard Specifications.

Fill the space between the raceway and the sleeve with mastic and jute. Install the mastic with a minimum distance of 2 inches at each end of the sleeve and the remaining interior space filled with jute. Finish the mastic by making it smooth and flush with the concrete.

Coordinate electrical conduit system work with work by others, and allow installation of circuitry or fiber optic cables during the construction process as directed by the Engineer.

Ensure that the concrete inserts are in the proper position and installed correctly, including when they are located in prestressed concrete deck panels.

Keep the raceway system clean of all debris during construction, with the completed system clean and ready for installation of circuitry or fiber optic cables.

## **BP-10**

Project I-5711

Alamance County

The Engineer must inspect and approve all work before concealment.

### **4.0 BASIS OF PAYMENT**

No direct measurement will be made for the conduit system, since it will be paid for on a lump sum basis.

Payment for the conduit system will be made at the contract lump sum price for “Electrical Conduit System for Signals at station 27+02.26 -L-”.

Such price and payment for the conduit system as provided above will be considered full compensation for all materials, equipment, and labor necessary to complete the work in accordance with the plans and these special provisions.

Payment will be made under:

Electrical Conduit System for Signals at station 27+02.26 -L- Lump Sum

**BP-11**

Project I-5711

Alamance County

**SHOTCRETE REPAIRS****(2-11-19)****1.0 GENERAL**

The work covered by this special provision consists of removing deteriorated concrete from the structure in accordance with the limits, depth and details shown on the plans, described herein and as established by the Engineer. This work also includes removing and disposing all loose debris, cleaning and repairing reinforcing steel and applying structural shotcrete.

The location and extent of repairs shown on the plans are general in nature. The Engineer shall determine the extent of removal in the field based on an evaluation of the condition of the exposed surfaces.

Any portion of the structure that is damaged from construction operations shall be repaired to the Engineer's satisfaction, at no extra cost to the Department.

**2.0 MATERIAL REQUIREMENTS**

Use prepackaged shotcrete conforming to the requirements of ASTM C1480, the applicable sections of the *Standard Specifications* and the following:

Test Description	Test Method	Age (Days)	Specified Requirements
Silica Fume (%)	ASTM C1240	-	10 (Max.)
Water/Cementitious Materials Ratio	-	-	0.40 (Max.)
Air Content - As Shot (%)	ASTM C231	-	4 ± 1
Slump - As Shot (Range in inches)	ASTM C143	-	2 - 3
Minimum Compressive Strength (psi)	ASTM C39	7 28	3,000 5,000
Minimum Bond Pull-off Strength (psi)	ASTM C1583	28	145
Rapid Chloride Permeability Tests (range in coulombs)	ASTM C1202	-	100 - 1000

Admixtures are not allowed unless approved by the Engineer. Store shotcrete in an environment where temperatures remain above 40°F and less than 95°F

All equipment must operate in accordance with the manufacturer's specifications and material must be placed within the recommended time.

## BP-12

Project I-5711

Alamance County

### 3.0 QUALITY CONTROL

#### (A) Qualification of Shotcrete Contractor

The shotcrete Contractor shall provide proof of experience by submitting a description of jobs similar in size and character that have been completed within the last five (5) years. The name, address and telephone number of references for the submitted projects shall also be furnished. Failure to provide appropriate documentation will result in the rejection of the proposed shotcrete contractor.

#### (B) Qualification of Nozzleman

The shotcrete Contractor's nozzleman shall be certified by the American Concrete Institute (ACI). Submit proof of certification to the Engineer prior to beginning repair work. The nozzleman shall maintain certification at all times while work is being performed for the Department. Failure to provide and maintain certification will result in the rejection of the proposed nozzleman.

### 4.0 TEMPORARY WORK PLATFORM

Prior to beginning any repair work, provide details for a sufficiently sized temporary work platform at each repair location. Design steel members to meet the requirements of the American Institute of Steel Construction Manual. Design timber members in accordance with the *National Design Specification for Stress-Grade Lumber and Its Fastenings* of the National Forest Products Association. Submit the platform design and plans for review and approval. The design and plans shall be sealed and signed by a North Carolina registered Professional Engineer. Do not install the platform until the design and plans are approved. Drilling holes in the superstructure for the purpose of attaching the platform is prohibited. Upon completion of work, remove all anchorages in the substructure and repair the substructure at no additional cost to the Department.

### 5.0 SURFACE PREPARATION

Prior to starting the repair operation, delineate all surfaces and areas assumed to be deteriorated by visually examining and sounding the concrete surface with a hammer or other approved method. The Engineer is the sole judge in determining the limits of deterioration.

Prior to removal, introduce a shallow saw cut approximately ½" in depth around the repair area at right angles to the concrete surface. Remove all deteriorated concrete 1 inch below the reinforcing steel with a 17 lb (maximum) pneumatic hammer with points that do not exceed the width of the shank or with hand picks or chisels as directed by the Engineer. Do not cut or remove the existing reinforcing steel. Unless specifically directed by the Engineer, do not remove concrete deeper than 1 inch below the reinforcing steel.

Abrasive blast all exposed concrete surfaces and existing reinforcing steel in repair areas to remove all debris, loose concrete, loose mortar, rust, scale, etc. After sandblasting examine the reinforcing steel to ensure at least 90% of the original diameter remains. If there is

## BP-13

Project I-5711

Alamance County

more than 10% reduction in the rebar diameter, splice in and securely tie supplemental reinforcing bars as directed by the Engineer.

Provide stainless welded wire fabric at each repair area larger than one square foot if the depth of the repair exceeds 2 inches from the "As Built" outside face. Provide a minimum 4" x 4" - 12 gage stainless welded wire fabric unless otherwise shown on the plans. Rigidly secure the welded wire fabric to existing steel or to  $\frac{3}{16}$ " diameter stainless hook fasteners adequately spaced to prevent sagging. Encase the welded wire fabric in shotcrete a minimum depth of 1½ inches.

The contractor has the option to use synthetic fiber reinforcement as an alternate to welded wire fabric if attaching welded wire fabric is impractical or if approved by the Engineer. Welded wire fabric and synthetic fiber reinforcement shall not be used in the same repair area.

Thoroughly clean the repair area of all dirt, grease, oil or foreign matter, and remove all loose or weakened material before applying shotcrete. Saturate the repair area with clean water the day before applying shotcrete. Bring the wetted surface to a saturated surface dry (SSD) condition prior to applying shotcrete and maintain this condition until the application begins. Use a blowpipe to facilitate removal of free surface water. Only oil-free compressed air is to be used in the blowpipe.

The time between removal of deteriorated concrete and applying shotcrete shall not exceed five (5) calendar days. If the time allowance exceeds (5) calendar days, prepare the surface at the direction of the Engineer before applying shotcrete.

### 6.0 APPLICATION AND SURFACE FINISH

Apply shotcrete only when the surface temperature of the repair area is greater than 40°F and less than 95°F. Do not apply shotcrete to frosted surfaces. Maintain shotcrete at a minimum temperature of 40°F for three (3) calendar days after placement.

Apply shotcrete in layers. The properties of the applied shotcrete determine the proper thickness of each layer or lift.

The nozzleman should hold the nozzle three (3) to four (4) feet from the surface being covered in a position that ensures the shotcrete strikes at right angles to the surface being covered without excessive impact. The nozzleman shall maintain the water amount at a practicable minimum, so the mix properly adheres to the repair area. Water content should not become high enough to cause the mix to sag or fall from vertical or inclined surfaces, or to separate in horizontal layers.

Use shooting wires or guide strips that do not entrap rebound sand. Use guide wires to provide a positive means of checking the total thickness of the shotcrete applied. Remove the guide wires prior to the final finish coat.

## BP-14

Project I-5711

Alamance County

To avoid leaving sand pockets in the shotcrete, blow or rake off sand that rebounds and does not fall clear of the work, or which collects in pockets in the work. Do not reuse rebound material in the work.

If a work stoppage longer than two (2) hours takes place on any shotcrete layer prior to the time it has been built up to required thickness, saturate the area with clean water and use a blowpipe as outlined previously, prior to continuing with the remaining shotcrete course. Do not apply shotcrete to a dry surface.

Finish all repaired areas, including chamfered edges, as close as practicable to their original "As Built" dimensions and configuration. Provide a minimum 2" of cover for reinforcing steel exposed during repair. Slightly build up and trim shotcrete to the final surface by cutting with the leading edge of a sharp trowel. Use a rubber float to correct any imperfections. Limit work on the finished surface to correcting imperfections caused by trowel cutting.

Immediately after bringing shotcrete surfaces to final thickness, thoroughly check for sags, bridging, and other deficiencies. Repair any imperfections at the direction of the Engineer.

Prevent finished shotcrete from drying out by maintaining 95% relative humidity at the repair and surrounding areas by fogging, moist curing or other approved means for seven (7) calendar days.

### 7.0 MATERIAL TESTING & ACCEPTANCE

Each day shotcreting takes place, the nozzleman shall shoot one 18" x 18" x 3" test panel in the same position as the repair work that is being done to demonstrate the shotcrete is being applied properly. Store, handle and cure the test panel in the same manner as the repaired substructure.

Approximately 72 hours after completing the final shotcrete placement, thoroughly test the surface with a hammer. At this time, the repair area should have sufficient strength for all sound sections to ring sharply. Remove and replace any unsound portions prior to the final inspection of the work. No additional compensation will be provided for removal and replacement of unsound shotcrete.

After seven (7) calendar days, core three (3) 3" diameter samples from each test panel and from the repaired structure as directed by the Engineer. Any cores taken from the structure shall penetrate into the existing structure concrete at least two (2) inches. Cores shall be inspected for delamination, sand pockets, tested for bond strength and compressive strength. If a core taken from a repaired structure unit indicates unsatisfactory application or performance of the shotcrete, take additional cores from the applicable structure unit(s) for additional evaluation and testing as directed by the Engineer. Any repair work failing to meet the requirements of this provision will be rejected and the Contractor shall implement a remediation plan to correct the deficiency at no additional cost to the Department. No extra payment will be provided for drilling extra cores. Patch all core holes in repaired structure units to the satisfaction of the Engineer. All material testing,



**BP-15**

Project I-5711

Alamance County

core testing and sampling will be done by the Materials and Tests Unit of North Carolina Department of Transportation.

**8.0 MEASUREMENT AND PAYMENT**

*Shotcrete Repairs* will be measured and paid for at the contract unit price bid per cubic foot and will be full compensation for removal, containment and disposal off-site of unsound concrete including the cost of materials, labor, tools, equipment and incidentals necessary to complete the repair work. Depth will be measured from the original outside concrete face. The Contractor and Engineer will measure quantities after removal of unsound concrete and before application of repair material. Payment will also include the cost of sandblasting, surface cleaning and preparation, cleaning of reinforcing steel, placement of new steel, cost of temporary work platform, testing for soundness, curing of shotcrete and taking core samples from the test panels and substructure units.

Payment will be made under:

**Pay Item**

Shotcrete Repairs

**Pay Unit**

Cubic Feet

## **BP-16**

Project I-5711

Alamance County

### **STEEL REINFORCED ELASTOMERIC BEARINGS**

**(6-22-16)**

The 2018 Standard Specifications shall be revised as follows:

In **Section 1079-2(A) – Elastomeric Bearings** add the following after the second paragraph:

Internal holding pins are required for all shim plates when the contract plans indicate the structure contains the necessary corrosion protection for a corrosive site.

Repair laminated (reinforced) bearing pads utilizing external holding pins via vulcanization. Submit product data for repair material and a detailed application procedure to the Materials and Tests Unit for approval before use and annually thereafter.

# BP-17

Project I-5711

Alamance County

## CONCRETE REPAIRS

(2-11-19)

### DESCRIPTION

Work includes removal of concrete in spalled, delaminated and/or cracked areas of the existing bent caps, bent columns, underside of bridge decks, deck slabs, girders, and bridge rails in reasonably close conformity with the lines, depth, and details shown on the plans, described herein and as established by the Engineer. This work also includes straightening, cleaning, and replacement of reinforcing steel, doweling new reinforcing steel, removing all loose materials, removing and disposing of debris, formwork, applying repair material, and protecting adjacent areas of the bridge and environment from material leakage. The repair material shall be one of the materials described in this Special Provision, unless otherwise noted in the plans or special provisions.

The location and extent of repairs shown on the plans described herein are general in nature. The Engineer shall determine the extent of removal in the field based on an evaluation of the condition of the exposed surfaces. The Contractor shall coordinate removal operations with the Engineer. No more than 30% of a round or square column or 30% of the bearing area under a beam shall be removed without a temporary support system and approval from the Engineer.

Repair, to the Engineer's satisfaction, any portion of the structure that is damaged from construction operations. No extra payment is provided for these repairs.

### SURFACE PREPARATION

Adhere to the following surface preparation requirements or the repair material manufacturer's requirements, whichever is more stringent.

Prior to starting the repair operation, delineate all surfaces and areas assumed to be deteriorated by visually examining and sounding the concrete surface with a hammer or other approved method. The Engineer is the sole judge in determining the limits of deterioration.

Prior to concrete removal, introduce a shallow saw cut, 1/2" in depth, around the repair area at right angles to the concrete surface. Sawcut should be located a minimum 2" beyond the perimeter of the deteriorated concrete area to be repaired. Remove all concrete within the sawcut to a minimum depth of 1/2". If concrete removal exposes reinforcing steel, remove all deteriorated concrete 1" below the reinforcing steel with a 17 lb (maximum) pneumatic hammer, with points that do not exceed the width of the shank, or with hand picks or chisels, as directed by the Engineer. Do not cut or remove the existing reinforcing steel. Unless specifically directed by the Engineer, do not remove concrete deeper than 1" below the reinforcing steel.

Abrasive blast all exposed concrete surfaces and existing reinforcing steel in repair areas to remove all debris, loose concrete, loose mortar, rust, scale, etc. After blasting, examine the reinforcing steel to ensure at least 90% of the original diameter remains. If there is more than 10% reduction in the rebar diameter, splice in and securely tie supplemental reinforcing bars as directed by the Engineer. This might require additional removal of concrete, in order to achieve an appropriate splice length of the reinforcing steel.

## BP-18

Project I-5711

Alamance County

Thoroughly clean the repair area of all dirt, grease, oil, or foreign matter, and remove all loose or weakened material by abrasive blasting before applying concrete repair material. Acid etch with 15% hydrochloric acid, only if approved by the Engineer. Follow acid etching by scrubbing and flushing with copious amounts of clean water. Check the cleaning using moist pH paper. Water cleaning is complete when the paper reads ten (10) or higher.

Follow all abrasive blasting with vacuum cleaning.

The time between removal of deteriorated concrete and applying concrete repair material shall not exceed 72 hours. If the time allowance exceeds 72 hours, prepare the surface at the direction of the Engineer before applying concrete repair material.

### APPLICATION AND SURFACE FINISH

Apply repair material to damp surfaces only when allowed by repair material recommendations and approved by the Engineer. Prepare damp surfaces in accordance with the *Standard Specifications* and/ or repair material manufacturer's recommendations. Use a blowpipe to facilitate removal of free surface water. Only oil-free compressed air is to be used in the blowpipe.

When surface preparation is completed, mix and apply repair material in accordance with the *Standard Specifications* and/ or repair material manufacturer's recommendations.

Use aggregate that is washed, kiln-dried, and bagged. Maximum size of aggregate shall not exceed 2/3 of the minimum depth of the repair area, or 3/4 of the depth of excavation behind the reinforcing steel, whichever is smaller.

Unless otherwise required by the repair material manufacturer, apply bonding agent to all repair areas immediately prior to placing repair material.

Repair areas shall be formed unless otherwise approved by the Engineer. Form and finish all repaired areas, including chamfered edges, as close as practicable to their original "As Built" dimensions and configuration. After applying the repair material, remove excessive material and provide a smooth, flush surface, unless directed otherwise.

Cure finished Class A concrete repair material by maintaining 95% relative humidity at the repair and surrounding areas by fogging, moist curing, or other approved means for seven (7) days. Cure polymer modified concrete repair material in accordance with manufacturer's recommendations.

### REPAIR MATERIAL OPTIONS

#### (A) Polymer Modified Concrete Repair Material

Repair material shall be polymer modified cement mortar for vertical or overhead applications and shall be suitable for applications in marine environments. Material shall be approved for use by NCDOT. Submit repair material to the Engineer for review and approval prior to beginning the work. Color of repair material shall be concrete gray.

**BP-19**

Project I-5711

Alamance County

**(B) Class A Concrete Repair Material**

Repair material shall be Class A Portland Cement Concrete as described in Article 1000-4 of the *Standard Specifications*.

**TEMPORARY WORK PLATFORM**

Prior to beginning any repair work, provide details for a sufficiently sized temporary work platform at each repair location. Design steel members to meet the requirements of the *American Institute of Steel Construction Manual*. Design timber members in accordance with the *National Design Specification for Stress-Grade Lumber and Its Fastenings* of the National Forest Products Association. Submit the platform design and plans for review and approval. The design and plans shall be sealed and signed by a North Carolina registered Professional Engineer. Do not install the platform until the design and plans are approved. Drilling holes in the superstructure for the purpose of attaching the platform is prohibited. Upon completion of work, remove all anchorages in the substructure and repair the substructure at no additional cost to the Department.

**MEASUREMENT AND PAYMENT**

*Concrete Repairs* will be measured and paid for at the contract unit price bid per cubic foot and will be full compensation for removal, containment and disposal off-site of unsound concrete including the cost of materials, reinforcing steel, labor, tools, equipment and incidentals necessary to complete the repair work. Depth will be measured from the original outside concrete face. The Contractor and Engineer will measure quantities after removal of unsound concrete and before application of repair material. Payment will also include the cost of abrasive blasting, surface cleaning and preparation, blast cleaning of reinforcing steel, placement of new reinforcing steel, cost of temporary work platform, testing of the soundness of the exposed concrete surface, furnishing and installation of repair mortar material, curing and sampling of concrete, and protection/cleaning of adjacent areas from splatter or leakage.

Reinforcing Steel that is required for the repairs will be in accordance with Section 425 of the *Standard Specifications*.

Payment will be made under:

<b>Pay Item</b>	<b>Pay Unit</b>
Concrete Repairs	Cubic Feet

# BP-20

Project I-5711

Alamance County

## THERMAL SPRAYED COATINGS (METALLIZATION)

(12-1-2017)

### 1.0 DESCRIPTION

Apply a thermal sprayed coating (TSC) and sealer to metal surfaces in accordance with the Thermal Sprayed Coatings (Metallization) Program and as specified herein when called for on the plans or by other Special Provisions. Use only Arc Sprayed application methods to apply TSC. The Engineer must approve other methods of application.

The Thermal Sprayed Coatings (Metallization) Program is available on the Materials and Tests Unit website.

### 2.0 QUALIFICATIONS

Only use NCDOT approved TSC Contractors meeting the requirements outlined in the Thermal Sprayed Coatings (Metallization) Program.

### 3.0 MATERIALS

Use only materials meeting the requirements of Section 7 of the Thermal Sprayed Coatings (Metallization) Program.

### 4.0 SURFACE PREPARATION AND TSC APPLICATION

Surface preparation of TSC surfaces shall meet the requirements of Section 8 of the Thermal Sprayed Coatings (Metallization) Program. Apply TSC with the alloy to the thickness specified on the plans or as required by Thermal Sprayed Coatings (Metallization) Program.

### 5.0 INSPECTION AND TESTING

The TSC Contractor must conduct inspections and tests listed in the Thermal Sprayed Coatings (Metallization) Program.

### 6.0 REPAIRS

Perform all shop repairs in accordance with the procedures outlined in the Thermal Sprayed Coatings (Metallization) Program.

Repairs associated with field welding shall be made by removing the existing metallizing by blast or power tool cleaning. Affected areas shall be addressed as follows:

- For Marine Environments, incorporate a minimum surface preparation in accordance with SSPC SP-11 (Power Tool Cleaning to Bare Metal) and require an approved epoxy mastic coating applied in accordance with the manufacturer's recommendation. Apply a minimum of two (2) coats at a rate of 5-7 (WFT) per coat to the affected area.

## **BP-21**

Project I-5711

Alamance County

- For Non-Marine Environments, incorporate a minimum surface preparation in accordance with SSPC SP-11 (Power Tool Cleaning to Bare Metal) and require an approved organic zinc-rich coating applied in accordance with the manufacturer's recommendation. Apply a minimum of two (2) coats at a rate of 5-7 (WFT) per coat to the affected area.
  1. Minor localized areas less than or equal to 0.1 ft<sup>2</sup> with exposed substrate shall be repaired as outlined above for marine and non-marine environments.
  2. Large localized areas greater than 0.1 ft<sup>2</sup> with exposed substrate shall require the Contractor to submit a detailed repair procedure to the Engineer for review and approval.
- Repair methods for areas where the substrate has not been exposed shall be mutually agreed upon between the Contractor and TSC Contractor as approved by the Engineer.

### **7.0 TWELVE MONTH OBSERVATION PERIOD**

All TSC materials applied under the Thermal Sprayed Coatings (Metallization) Program shall be evaluated twelve (12) months after project acceptance for defective materials and workmanship.

### **8. BASIS OF PAYMENT**

The contract price bid for the metal component to which the TSC is applied will be full compensation for the thermal sprayed coating.

## BP-22

Project I-5711

Alamance County

### **FALSEWORK AND FORMWORK**

**(4-5-12)**

#### **1.0 DESCRIPTION**

Use this Special Provision as a guide to develop temporary works submittals required by the Standard Specifications or other provisions; no additional submittals are required herein. Such temporary works include, but are not limited to, falsework and formwork.

Falsework is any temporary construction used to support the permanent structure until it becomes self-supporting. Formwork is the temporary structure or mold used to retain plastic or fluid concrete in its designated shape until it hardens. Access scaffolding is a temporary structure that functions as a work platform that supports construction personnel, materials, and tools, but is not intended to support the structure. Scaffolding systems that are used to temporarily support permanent structures (as opposed to functioning as work platforms) are considered to be falsework under the definitions given. Shoring is a component of falsework such as horizontal, vertical, or inclined support members. Where the term “temporary works” is used, it includes all of the temporary facilities used in bridge construction that do not become part of the permanent structure.

Design and construct safe and adequate temporary works that will support all loads imposed and provide the necessary rigidity to achieve the lines and grades shown on the plans in the final structure.

#### **2.0 MATERIALS**

Select materials suitable for temporary works; however, select materials that also ensure the safety and quality required by the design assumptions. The Engineer has authority to reject material on the basis of its condition, inappropriate use, safety, or nonconformance with the plans. Clearly identify allowable loads or stresses for all materials or manufactured devices on the plans. Revise the plan and notify the Engineer if any change to materials or material strengths is required.

#### **3.0 DESIGN REQUIREMENTS**

##### **A. Working Drawings**

Provide working drawings for items as specified in the contract, or as required by the Engineer, with design calculations and supporting data in sufficient detail to permit a structural and safety review of the proposed design of the temporary work.

On the drawings, show all information necessary to allow the design of any component to be checked independently as determined by the Engineer.

When concrete placement is involved, include data such as the drawings of proposed sequence, rate of placement, direction of placement, and location of all construction joints. Submit the number of copies as called for by the contract.



**BP-23**

Project I-5711

Alamance County

When required, have the drawings and calculations prepared under the guidance of, and sealed by, a North Carolina Registered Professional Engineer who is knowledgeable in temporary works design.

If requested by the Engineer, submit with the working drawings manufacturer's catalog data listing the weight of all construction equipment that will be supported on the temporary work. Show anticipated total settlements and/or deflections of falsework and forms on the working drawings. Include falsework footing settlements, joint take-up, and deflection of beams or girders.

As an option for the Contractor, overhang falsework hangers may be uniformly spaced, at a maximum of 36 inches, provided the following conditions are met:

Member Type (PCG)	Member Depth, (inches)	Max. Overhang Width, (inches)	Max. Slab Edge Thickness, (inches)	Max. Screenshot Wheel Weight, (lbs.)	Bracket Min. Vertical Leg Extension, (inches)
II	36	39	14	2000	26
III	45	42	14	2000	35
IV	54	45	14	2000	44
MBT	63	51	12	2000	50
MBT	72	55	12	1700	48

Overhang width is measured from the centerline of the girder to the edge of the deck slab.

For Type II, III & IV prestressed concrete girders (PCG), 45-degree cast-in-place half hangers and rods must have a minimum safe working load of 6,000 lbs.

For MBT prestressed concrete girders, 45-degree angle holes for falsework hanger rods shall be cast through the girder top flange and located, measuring along the top of the member, 1'-2 1/2" from the edge of the top flange. Hanger hardware and rods must have a minimum safe working load of 6,000 lbs.

The overhang bracket provided for the diagonal leg shall have a minimum safe working load of 3,750 lbs. The vertical leg of the bracket shall extend to the point that the heel bears on the girder bottom flange, no closer than 4 inches from the bottom of the member. However, for 72-inch members, the heel of the bracket shall bear on the web, near the bottom flange transition.

Provide adequate overhang falsework and determine the appropriate adjustments for deck geometry, equipment, casting procedures and casting conditions.

If the optional overhang falsework spacing is used, indicate this on the falsework submittal and advise the girder producer of the proposed details. Failure to notify the Engineer of hanger type and hanger spacing on prestressed concrete girder casting drawings may delay the approval of those drawings.

**BP-24**

Project I-5711

Alamance County

Falsework hangers that support concentrated loads and are installed at the edge of thin top flange concrete girders (such as bulb tee girders) shall be spaced so as not to exceed 75% of the manufacturer's stated safe working load. Use of dual leg hangers (such as Meadow Burke HF-42 and HF-43) are not allowed on concrete girders with thin top flanges. Design the falsework and forms supporting deck slabs and overhangs on girder bridges so that there will be no differential settlement between the girders and the deck forms during placement of deck concrete.

When staged construction of the bridge deck is required, detail falsework and forms for screed and fluid concrete loads to be independent of any previous deck pour components when the mid-span girder deflection due to deck weight is greater than  $\frac{3}{4}$ ".

Note on the working drawings any anchorages, connectors, inserts, steel sleeves or other such devices used as part of the falsework or formwork that remains in the permanent structure. If the plan notes indicate that the structure contains the necessary corrosion protection required for a Corrosive Site, epoxy coat, galvanize or metalize these devices. Electroplating will not be allowed. Any coating required by the Engineer will be considered incidental to the various pay items requiring temporary works.

Design falsework and formwork requiring submittals in accordance with the 1995 AASHTO *Guide Design Specifications for Bridge Temporary Works* except as noted herein.

### 1. Wind Loads

Table 2.2 of Article 2.2.5.1 is modified to include wind velocities up to 110 mph. In addition, Table 2.2A is included to provide the maximum wind speeds by county in North Carolina.

**Table 2.2 - Wind Pressure Values**

Height Zone feet above ground	Pressure, lb/ft <sup>2</sup> for Indicated Wind Velocity, mph				
	70	80	90	100	110
0 to 30	15	20	25	30	35
30 to 50	20	25	30	35	40
50 to 100	25	30	35	40	45
over 100	30	35	40	45	50

### 2. Time of Removal

The following requirements replace those of Article 3.4.8.2.

Do not remove forms until the concrete has attained strengths required in Article 420-16 of the Standard Specifications and these Special Provisions.

Do not remove forms until the concrete has sufficient strength to prevent damage to the surface.

**BP-25**

Project I-5711

Alamance County

**Table 2.2A - Steady State Maximum Wind Speeds by Counties in North Carolina**

COUNTY	25 YR (mph)	COUNTY	25 YR (mph)	COUNTY	25 YR (mph)
Alamance	70	Franklin	70	Pamlico	100
Alexander	70	Gaston	70	Pasquotank	100
Alleghany	70	Gates	90	Pender	100
Anson	70	Graham	80	Perquimans	100
Ashe	70	Granville	70	Person	70
Avery	70	Greene	80	Pitt	90
Beaufort	100	Guilford	70	Polk	80
Bertie	90	Halifax	80	Randolph	70
Bladen	90	Harnett	70	Richmond	70
Brunswick	100	Haywood	80	Robeson	80
Buncombe	80	Henderson	80	Rockingham	70
Burke	70	Hertford	90	Rowan	70
Cabarrus	70	Hoke	70	Rutherford	70
Caldwell	70	Hyde	110	Sampson	90
Camden	100	Iredell	70	Scotland	70
Carteret	110	Jackson	80	Stanley	70
Caswell	70	Johnston	80	Stokes	70
Catawba	70	Jones	100	Surry	70
Cherokee	80	Lee	70	Swain	80
Chatham	70	Lenoir	90	Transylvania	80
Chowan	90	Lincoln	70	Tyrell	100
Clay	80	Macon	80	Union	70
Cleveland	70	Madison	80	Vance	70
Columbus	90	Martin	90	Wake	70
Craven	100	McDowell	70	Warren	70
Cumberland	80	Mecklenburg	70	Washington	100
Currituck	100	Mitchell	70	Watauga	70
Dare	110	Montgomery	70	Wayne	80
Davidson	70	Moore	70	Wilkes	70
Davie	70	Nash	80	Wilson	80
Duplin	90	New Hanover	100	Yadkin	70
Durham	70	Northampton	80	Yancey	70
Edgecombe	80	Onslow	100		
Forsyth	70	Orange	70		

## BP-26

Project I-5711

Alamance County

### B. Review and Approval

The Engineer is responsible for the review and approval of temporary works' drawings.

Submit the working drawings sufficiently in advance of proposed use to allow for their review, revision (if needed), and approval without delay to the work.

The time period for review of the working drawings does not begin until complete drawings and design calculations, when required, are received by the Engineer.

Do not start construction of any temporary work for which working drawings are required until the drawings have been approved. Such approval does not relieve the Contractor of the responsibility for the accuracy and adequacy of the working drawings.

## 4.0 CONSTRUCTION REQUIREMENTS

All requirements of Section 420 of the Standard Specifications apply.

Construct temporary works in conformance with the approved working drawings. Ensure that the quality of materials and workmanship employed is consistent with that assumed in the design of the temporary works. Do not weld falsework members to any portion of the permanent structure unless approved. Show any welding to the permanent structure on the approved construction drawings.

Provide tell-tales attached to the forms and extending to the ground, or other means, for accurate measurement of falsework settlement. Make sure that the anticipated compressive settlement and/or deflection of falsework does not exceed 1 inch. For cast-in-place concrete structures, make sure that the calculated deflection of falsework flexural members does not exceed 1/240 of their span regardless of whether or not the deflection is compensated by camber strips.

### A. Maintenance and Inspection

Inspect and maintain the temporary work in an acceptable condition throughout the period of its use. Certify that the manufactured devices have been maintained in a condition to allow them to safely carry their rated loads. Clearly mark each piece so that its capacity can be readily determined at the job site.

Perform an in-depth inspection of an applicable portion(s) of the temporary works, in the presence of the Engineer, not more than 24 hours prior to the beginning of each concrete placement. Inspect other temporary works at least once a month to ensure that they are functioning properly. Have a North Carolina Registered Professional Engineer inspect the cofferdams, shoring, sheathing, support of excavation structures, and support systems for load tests prior to loading.

## **BP-27**

Project I-5711

Alamance County

### **B. Foundations**

Determine the safe bearing capacity of the foundation material on which the supports for temporary works rest. If required by the Engineer, conduct load tests to verify proposed bearing capacity values that are marginal or in other high-risk situations.

The use of the foundation support values shown on the contract plans of the permanent structure is permitted if the foundations are on the same level and on the same soil as those of the permanent structure.

Allow for adequate site drainage or soil protection to prevent soil saturation and washout of the soil supporting the temporary works supports.

If piles are used, the estimation of capacities and later confirmation during construction using standard procedures based on the driving characteristics of the pile is permitted. If preferred, use load tests to confirm the estimated capacities; or, if required by the Engineer conduct load tests to verify bearing capacity values that are marginal or in other high risk situations.

The Engineer reviews and approves the proposed pile and soil bearing capacities.

### **5.0 REMOVAL**

Unless otherwise permitted, remove and keep all temporary works upon completion of the work. Do not disturb or otherwise damage the finished work.

Remove temporary works in conformance with the contract documents. Remove them in such a manner as to permit the structure to uniformly and gradually take the stresses due to its own weight.

### **6.0 METHOD OF MEASUREMENT**

Unless otherwise specified, temporary works will not be directly measured.

### **7.0 BASIS OF PAYMENT**

Payment at the contract unit prices for the various pay items requiring temporary works will be full compensation for the above falsework and formwork.

**BP-28**

Project I-5711

Alamance County

**SUBMITTAL OF WORKING DRAWINGS****(6-28-17)****1.0 GENERAL**

Submit working drawings in accordance with Article 105-2 of the *Standard Specifications* and this provision. For this provision, “submittals” refers to only those listed in this provision. The list of submittals contained herein does not represent a list of required submittals for the project. Submittals are only necessary for those items as required by the contract. Make submittals that are not specifically noted in this provision directly to the Engineer. Either the Structures Management Unit or the Geotechnical Engineering Unit or both units will jointly review submittals.

If a submittal contains variations from plan details or specifications or significantly affects project cost, field construction or operations, discuss the submittal with and submit all copies to the Engineer. State the reason for the proposed variation in the submittal. To minimize review time, make sure all submittals are complete when initially submitted. Provide a contact name and information with each submittal. Direct any questions regarding submittal requirements to the Engineer, Structures Management Unit contacts or the Geotechnical Engineering Unit contacts noted below.

In order to facilitate in-plant inspection by NCDOT and approval of working drawings, provide the name, address and telephone number of the facility where fabrication will actually be done if different than shown on the title block of the submitted working drawings. This includes, but is not limited to, precast concrete items, prestressed concrete items and fabricated steel or aluminum items.

**2.0 ADDRESSES AND CONTACTS**

For submittals to the Structures Management Unit, use the following addresses:

Via US mail:

Mr. B. C. Hanks, P. E.  
State Structures Engineer  
North Carolina Department  
of Transportation  
Structures Management Unit  
1581 Mail Service Center  
Raleigh, NC 27699-1581

Attention: Mr. J. L. Bolden, P. E.

Via other delivery service:

Mr. B. C. Hanks, P. E.  
State Structures Engineer  
North Carolina Department  
of Transportation  
Structures Management Unit  
1000 Birch Ridge Drive  
Raleigh, NC 27610

Attention: Mr. J. L. Bolden, P. E.

Submittals may also be made via email.

Send submittals to:

[jlbolden@ncdot.gov](mailto:jlbolden@ncdot.gov) (James Bolden)

Send an additional e-copy of the submittal to the following address:

[eomile@ncdot.gov](mailto:eomile@ncdot.gov) (Emmanuel Omile)

## BP-29

Project I-5711

Alamance County

[mrorie@ncdot.gov](mailto:mrorie@ncdot.gov) (Madonna Rorie)

For submittals to the Geotechnical Engineering Unit, use the following addresses:

For projects in Divisions 1-7, use the following Eastern Regional Office address:

Via US mail:

Mr. Chris Kreider, P. E.  
Eastern Regional Geotechnical  
Manager  
North Carolina Department  
of Transportation  
Geotechnical Engineering Unit  
Eastern Regional Office  
1570 Mail Service Center  
Raleigh, NC 27699-1570

Via other delivery service:

Mr. Chris Kreider, P. E.  
Eastern Regional Geotechnical  
Manager  
North Carolina Department  
of Transportation  
Geotechnical Engineering Unit  
Eastern Regional Office  
3301 Jones Sausage Road, Suite 100  
Garner, NC 27529

Via Email: [EastGeotechnicalSubmittal@ncdot.gov](mailto:EastGeotechnicalSubmittal@ncdot.gov)

For projects in Divisions 8-14, use the following Western Regional Office address:

Via US mail or other delivery service:

Mr. Eric Williams, P. E.  
Western Regional Geotechnical  
Manager  
North Carolina Department  
of Transportation  
Geotechnical Engineering Unit  
Western Regional Office  
5253 Z Max Boulevard  
Harrisburg, NC 28075

Via Email: [WestGeotechnicalSubmittal@ncdot.gov](mailto:WestGeotechnicalSubmittal@ncdot.gov)

The status of the review of structure-related submittals sent to the Structures Management Unit can be viewed from the Unit's website, via the "Drawing Submittal Status" link.

The status of the review of geotechnical-related submittals sent to the Geotechnical Engineering Unit can be viewed from the Unit's website, via the "Geotechnical Construction Submittals" link.

Direct any questions concerning submittal review status, review comments or drawing markups to the following contacts:

Primary Structures Contact:

James Bolden (919) 707 – 6408  
(919) 250 – 4082 facsimile  
[jlbolden@ncdot.gov](mailto:jlbolden@ncdot.gov)

**BP-30**

Project I-5711

Alamance County

Secondary Structures Contacts: Emmanuel Omile (919) 707 – 6451  
 Madonna Rorie (919) 707 – 6508

Eastern Regional Geotechnical Contact (Divisions 1-7):  
 Chris Kreider (919) 662 – 4710  
[ckreider@ncdot.gov](mailto:ckreider@ncdot.gov)

Western Regional Geotechnical Contact (Divisions 8-14):  
 Eric Williams (704) 455 – 8902  
[ewilliams3@ncdot.gov](mailto:ewilliams3@ncdot.gov)

**3.0 SUBMITTAL COPIES**

Furnish one complete copy of each submittal, including all attachments, to the Engineer. At the same time, submit the number of hard copies shown below of the same complete submittal directly to the Structures Management Unit and/or the Geotechnical Engineering Unit.

The first table below covers “Structure Submittals”. The Engineer will receive review comments and drawing markups for these submittals from the Structures Management Unit. The second table in this section covers “Geotechnical Submittals”. The Engineer will receive review comments and drawing markups for these submittals from the Geotechnical Engineering Unit.

Unless otherwise required, submit one set of supporting calculations to either the Structures Management Unit or the Geotechnical Engineering Unit unless both units require submittal copies in which case submit a set of supporting calculations to each unit. Provide additional copies of any submittal as directed.

**STRUCTURE SUBMITTALS**

<b>Submittal</b>	<b>Copies Required by Structures Management Unit</b>	<b>Copies Required by Geotechnical Engineering Unit</b>	<b>Contract Reference Requiring Submittal <sup>1</sup></b>
Arch Culvert Falsework	5	0	Plan Note, SN Sheet & “Falsework and Formwork”
Box Culvert Falsework <sup>7</sup>	5	0	Plan Note, SN Sheet & “Falsework and Formwork”
Cofferdams	6	2	Article 410-4
Foam Joint Seals <sup>6</sup>	9	0	“Foam Joint Seals”



**BP-31**

Project I-5711

Alamance County

Expansion Joint Seals (hold down plate type with base angle)	9	0	“Expansion Joint Seals”
Expansion Joint Seals (modular)	2, then 9	0	“Modular Expansion Joint Seals”
Expansion Joint Seals (strip seals)	9	0	“Strip Seals”
Falsework & Forms <sup>2</sup> (substructure)	8	0	Article 420-3 & “Falsework and Formwork”
Falsework & Forms (superstructure)	8	0	Article 420-3 & “Falsework and Formwork”
Girder Erection over Railroad	5	0	Railroad Provisions
Maintenance and Protection of Traffic Beneath Proposed Structure	8	0	“Maintenance and Protection of Traffic Beneath Proposed Structure at Station ____”
Metal Bridge Railing	8	0	Plan Note
Metal Stay-in-Place Forms	8	0	Article 420-3
Metalwork for Elastomeric Bearings <sup>4,5</sup>	7	0	Article 1072-8
Miscellaneous Metalwork <sup>4,5</sup>	7	0	Article 1072-8
Disc Bearings <sup>4</sup>	8	0	“Disc Bearings”
Overhead and Digital Message Signs (DMS) (metalwork and foundations)	13	0	Applicable Provisions
Placement of Equipment on Structures (cranes, etc.)	7	0	Article 420-20
Precast Concrete Box Culverts	2, then 1 reproducible	0	“Optional Precast Reinforced Concrete Box Culvert at Station ____”
Prestressed Concrete Cored Slab (detensioning sequences) <sup>3</sup>	6	0	Article 1078-11
Prestressed Concrete Deck Panels	6 and	0	Article 420-3

**BP-32**

Project I-5711

Alamance County

	1 reproducible		
Prestressed Concrete Girder (strand elongation and detensioning sequences)	6	0	Articles 1078-8 and 1078- 11
Removal of Existing Structure over Railroad	5	0	Railroad Provisions
Revised Bridge Deck Plans (adaptation to prestressed deck panels)	2, then 1 reproducible	0	Article 420-3
Revised Bridge Deck Plans (adaptation to modular expansion joint seals)	2, then 1 reproducible	0	“Modular Expansion Joint Seals”
Sound Barrier Wall (precast items)	10	0	Article 1077-2 & “Sound Barrier Wall”
Sound Barrier Wall Steel Fabrication Plans <sup>5</sup>	7	0	Article 1072-8 & “Sound Barrier Wall”
Structural Steel <sup>4</sup>	2, then 7	0	Article 1072-8
Temporary Detour Structures	10	2	Article 400-3 & “Construction, Maintenance and Removal of Temporary Structure at Station _____”
TFE Expansion Bearings <sup>4</sup>	8	0	Article 1072-8

**FOOTNOTES**

1. References are provided to help locate the part of the contract where the submittals are required. References in quotes refer to the provision by that name. Articles refer to the *Standard Specifications*.
2. Submittals for these items are necessary only when required by a note on plans.
3. Submittals for these items may not be required. A list of pre-approved sequences is available from the producer or the Materials & Tests Unit.
4. The fabricator may submit these items directly to the Structures Management Unit.
5. The two sets of preliminary submittals required by Article 1072-8 of the *Standard Specifications* are not required for these items.
6. Submittals for Fabrication Drawings are not required. Submittals for Catalogue Cuts of Proposed Material are required. See Section 5.A of the referenced provision.
7. Submittals are necessary only when the top slab thickness is 18” or greater.

**BP-33**

Project I-5711

Alamance County

**GEOTECHNICAL SUBMITTALS**

<b>Submittal</b>	<b>Copies Required by Geotechnical Engineering Unit</b>	<b>Copies Required by Structures Management Unit</b>	<b>Contract Reference Requiring Submittal <sup>1</sup></b>
Drilled Pier Construction Plans <sup>2</sup>	1	0	Subarticle 411-3(A)
Crosshole Sonic Logging (CSL) Reports <sup>2</sup>	1	0	Subarticle 411-5(A)(2)
Pile Driving Equipment Data Forms <sup>2,3</sup>	1	0	Subarticle 450-3(D)(2)
Pile Driving Analyzer (PDA) Reports <sup>2</sup>	1	0	Subarticle 450-3(F)(3)
Retaining Walls <sup>4</sup>	1 drawings, 1 calculations	2 drawings	Applicable Provisions
Temporary Shoring <sup>4</sup>	1 drawings, 1 calculations	2 drawings	“Temporary Shoring” & “Temporary Soil Nail Walls”

**FOOTNOTES**

- References are provided to help locate the part of the contract where the submittals are required. References in quotes refer to the provision by that name. Subarticles refer to the *Standard Specifications*.
- Submit one hard copy of submittal to the Engineer. Submit a second copy of submittal electronically (PDF via email), US mail or other delivery service to the appropriate Geotechnical Engineering Unit regional office. Electronic submission is preferred.
- The Pile Driving Equipment Data Form is available from:  
[https://connect.ncdot.gov/resources/Geological/Pages/Geotech\\_Forms\\_Details.aspx](https://connect.ncdot.gov/resources/Geological/Pages/Geotech_Forms_Details.aspx)  
See second page of form for submittal instructions.
- Electronic copy of submittal is required. See referenced provision.

**BP-34**

Project I-5711

Alamance County

**CRANE SAFETY****(6-20-19)**

Comply with the manufacturer specifications and limitations applicable to the operation of any and all cranes and derricks. Prime contractors, sub-contractors, and fully operated rental companies shall comply with the current Occupational Safety and Health Administration (OSHA) regulations.

Submit all items listed below to the Engineer prior to beginning crane operations. Changes in personnel or equipment must be reported to the Engineer and all applicable items listed below must be updated and submitted prior to continuing with crane operations.

**CRANE SAFETY SUBMITTAL LIST**

- A. **Competent Person:** Provide the name and qualifications of the “Competent Person” responsible for crane safety and lifting operations. The named competent person will have the responsibility and authority to stop any work activity due to safety concerns.
- B. **Riggers:** Provide the qualifications and experience of the persons responsible for rigging operations. Qualifications and experience should include, but not be limited to, weight calculations, center of gravity determinations, selection and inspection of sling and rigging equipment, and safe rigging practices.
- C. **Crane Inspections:** Inspection records for all cranes shall be current and readily accessible for review upon request.
- D. **Certifications:** Crane operators shall be certified by the National Commission for the Certification of Crane Operators (NCCCO) or the National Center for Construction Education and Research (NCCER). Other approved nationally accredited programs will be considered upon request. In addition, crane operators shall have a current CDL medical card. Submit a list of crane operator(s) and include current certification for each type of crane operated (small hydraulic, large hydraulic, small lattice, large lattice) and medical evaluations for each operator.

# BP-35

Project I-5711

Alamance County

## **GROUT FOR STRUCTURES**

(12-1-17)

### **1.0 DESCRIPTION**

This special provision addresses grout for use in pile blockouts, grout pockets, shear keys, dowel holes and recesses for structures. This provision does not apply to grout placed in post-tensioning ducts for bridge beams, girders, decks, end bent caps, or bent caps. Mix and place grout in accordance with the manufacturer's recommendations, the applicable sections of the Standard Specifications and this provision.

### **2.0 MATERIAL REQUIREMENTS**

Unless otherwise noted on the plans, use a Type 3 Grout in accordance with Section 1003 of the Standard Specifications.

Initial setting time shall not be less than 10 minutes when tested in accordance with ASTM C266.

Construction loading and traffic loading shall not be allowed until the 3 day compressive strength is achieved.

### **3.0 SAMPLING AND PLACEMENT**

Place and maintain components in final position until grout placement is complete and accepted. Concrete surfaces to receive grout shall be free of defective concrete, laitance, oil, grease and other foreign matter. Saturate concrete surfaces with clean water and remove excess water prior to placing grout.

### **4.0 BASIS OF PAYMENT**

No separate payment will be made for "Grout for Structures". The cost of the material, equipment, labor, placement, and any incidentals necessary to complete the work shall be considered incidental to the structure item requiring grout.

## BP-36

Project I-5711

Alamance County

### **BRIDGE MOUNTED CHAIN LINK FENCE**

**(SPECIAL)**

Construct the chain link fence in accordance with the applicable sections of the Standard Specifications, the details shown on the plans and this special provision.

The quantity of chain link fence will be the actual number of linear feet of fence, measured in place from end post to end post, which has been completed and accepted. All posts used for the chain link fence are included in the price of the fence and will not be paid for separately. There will be no measurement made for installing adhesive anchors in concrete barrier rail as such work is considered incidental.

Work includes but is not limited to furnishing and installing fence fabric, tie wires, stretcher bars, stretcher bar bands, tie rods, turnbuckles, brace rails, posts, post caps, brackets, adhesive anchors, fittings and any other materials necessary to complete the work as described in the plans and this special provision.

Payment will be made under:

104" Chain Link Fence \_\_\_\_\_ Linear Foot

**BP-37**

Project I-5711

Alamance County

**FOAM JOINT SEALS****(SPECIAL)****1.0 SEALS**

Use preformed seals compatible with concrete and resistant to abrasion, oxidation, oils, gasoline, salt and other materials that are spilled on or applied to the surface. Use a resilient, UV stable, preformed, impermeable, flexible, expansion joint seal. The joint seal shall consist of low-density, closed cell, cross-linked polyethylene non-extrudable, foam. The joint seal shall contain no EVA (Ethylene Vinyl Acetate). Cell generation shall be achieved by being physically blown using nitrogen. No chemical blowing agents shall be used in the cell generation process.

Use seals manufactured with grooves  $1/8'' \pm$  wide by  $1/8'' \pm$  deep and spaced between  $1/4''$  and  $1/2''$  apart along the bond surface running the length of the joint. Use seals with a depth that meets the manufacturer's recommendation, but is not less than 70% of the uncompressed width. Provide a seal designed so that, when compressed, the center portion of the top does not extend upward above the original height of the seal by more than  $1/4''$ . Provide a seal that has a working range of 30% tension and 60% compression and meets the requirements given below.

TEST	TEST METHOD	REQUIREMENT
Tensile strength	ASTM D3575-08, Suffix T	110 – 130 psi
Compression Set	ASTM D1056 Suffix B, 2 hr recovery	10% - 16%
Water Absorption	ASTM D3575	< 0.03 lb/ft <sup>2</sup>
Elongation at Break	ASTM D3575	180% - 210%
Tear Strength	ASTM D624 (D3575-08, Suffix G)	14 – 20 pli
Density	ASTM D3575-08, Suffix W, Method A	1.8 – 2.2 lb/ft <sup>3</sup>
Toxicity	ISO-10993.5	Pass (not cytotoxic)

Have the top of the joint seal clearly shop marked. Inspect the joint seals upon receipt to ensure that the marks are clearly visible before installation.

# BP-38

Project I-5711

Alamance County

## 2.0 BONDING ADHESIVE

Use a two component, 100% solid, modified epoxy adhesive supplied by the joint seal manufacturer that meets the requirements given below.

TEST	TEST METHOD	REQUIREMENT
Tensile strength	ASTM D638	3000 psi (min.)
Compressive strength	ASTM D695	7000 psi (min.)
Hardness	Shore D Scale	75-85 psi
Water Absorption	ASTM D570	0.25% by weight max.
Elongation to Break	ASTM D638	5% (max.)
Bond Strength	ASTM C882	2000 psi (min.)

Use an adhesive that is workable to 40°F. When installing in ambient air or surface temperatures below 40°F or for application on moist, difficult to dry concrete surfaces, use an adhesive specified by the manufacturer of the joint seal.

## 3.0 SAWING THE JOINT

The joint opening shall be initially formed to the width shown on the plans.

The polyester polymer concrete overlay shall have sufficient time to cure such that no damage can occur to the polyester polymer concrete overlay prior to sawing to the final width and depth as specified in the plans.

When sawing the joint to receive the foam seal, always use a rigid guide to control the saw in the desired direction. To control the saw and to produce a straight line as indicated on the plans, anchor and positively connect a template or a track to the bridge deck. Do not saw the joint by visual means such as a chalk line. Fill the holes used for holding the template or track to the deck with an approved, flowable non-shrink, non-metallic grout.

Saw cut to the desired width and depth in one or two passes of the saw by placing and spacing two metal blades on the saw shaft to the desired width for the joint opening.

The desired depth is the depth of the seal plus 1/4" above the top of the seal plus approximately 1" below the bottom of the seal. An irregular bottom of sawed joint is permitted as indicated on the plans. Grind exposed corners on saw cut edges to a 1/4" chamfer.

Saw cut a straight joint, centered over the formed opening and to the desired width specified in the plans. Prevent any chipping or damage to the sawed edges of the joint.

Remove any staining or deposited material resulting from sawing with a wet blade to the satisfaction of the Engineer.



## BP-39

Project I-5711

Alamance County

### 4.0 PREPARATION OF SAWED JOINT FOR SEAL INSTALLATION

The polyester polymer concrete overlay shall cure a minimum of 24 hours prior to seal installation.

After sawing the joint, the Engineer will thoroughly inspect the sawed joint opening for spalls, popouts, cracks, etc. All necessary repairs will be made by the Contractor prior to blast cleaning and installing the seal.

Clean the joints by sandblasting with clean dry sand immediately before placing the bonding agent. Sandblast the joint opening to provide a firm, clean joint surface free of curing compound, loose material and any foreign matter. Sandblast the joint opening without causing pitting or uneven surfaces. The aggregate in the elastomeric concrete may be exposed after sandblasting.

After blasting, either brush the surface with clean brushes made of hair, bristle or fiber, blow the surface with compressed air, or vacuum the surface until all traces of blast products and abrasives are removed from the surface, pockets, and corners.

If nozzle blasting is used to clean the joint opening, use compressed air that does not contain detrimental amounts of water or oil.

Examine the blast cleaned surface and remove any traces of oil, grease or smudge deposited in the cleaning operations.

Bond the seal to the blast cleaned surface on the same day the surface is blast cleaned.

### 5.0 SEAL INSTALLATION

Install the joint seal according to the manufacturer's procedures and recommendations and as recommended below. Do not install the joint seal if the ambient air or surface temperature is below 45°F. Have a manufacturer's certified trained factory representative present during the installation of the first seal of the project.

Before installing the joint seal, check the uninstalled seal length to insure the seal is the same length as each construction stage width as indicted on the plans. When the joint seal requires splicing, use the heat welding method by placing the joint material ends against a teflon heating iron of 425-475°F for 7 - 10 seconds, then pressing the ends together tightly. Do not test the welding until the material has completely cooled.

Begin installation by protecting the top edges of the concrete deck adjacent to the vertical walls of the joint as a means to minimize clean up. After opening both cans of the bonding agent, stir each can using separate stirring rods for each component to prevent premature curing of the bonding agent. Pour the two components, at the specified mixing ratio, into a clean mixing bucket. Mix the components with a low speed drill (400 rpm max.) until a uniform gray color is achieved without visible marbling. Apply bonding agent to both sides of the elastomeric concrete as well as both sides of the joint seal, making certain to

## **BP-40**

Project I-5711

Alamance County

completely fill the grooves with epoxy. With gloved hands, compress the joint seal and with the help of a blunt probe, push the seal into the joint opening until the seal is recessed approximately 1/4" below the surface. When pushing down on the joint seal, apply pressure only in a downward direction. Do not push the joint seal into the joint opening at an angle that would stretch the material. Seals that are stretched during installation shall be removed and rejected. Once work on placing a seal begins, do not stop until it is completed. Clean the excess epoxy from the top of the joint seal immediately with a trowel. Do not use solvents or any cleaners to remove the excess epoxy from the top of the seal. Remove the protective cover at the joint edges and check for any excess epoxy on the surface. Remove excess epoxy with a trowel, the use of solvents or any cleaners will not be allowed.

The installed system shall be watertight and will be monitored until final inspection and approval. Do not place pavement markings on top of foam joint seals.

### **6.0 BASIS OF PAYMENT**

Payment for all foam joint seals will be at the lump sum contract price bid for "Foam Joint Seals". Prices and payment will be full compensation for furnishing all material, including demolition of the existing bridge joints, labor, tools and equipment necessary for installing these units in place and accepted.

# BP-41

Project I-5711

Alamance County

## EPOXY COATING

(SPECIAL)

### 1.0 GENERAL

This work applies to all end bents and interior bents on the project bridge. Clean, wash and epoxy coat top of all end bents and interior bents caps.

Use a Type 4A flexible and moisture insensitive epoxy coating in accordance with Section 1081. Provide a Type 3 material certification in accordance with Article 106-3 showing the proposed epoxy meets Type 4A requirements.

### 2.0 SURFACE

Apply the epoxy protective coating to the top surface area, including chamfer area of all end bents and interior bents caps, excluding areas under elastomeric bearings.

Thoroughly clean all dust, dirt, grease, oil, laitance and other objectionable material from the concrete surface to be coated. Air blast all surface immediately before applying the protective coating.

Use only cleaning agents preapproved by the Engineer.

### 3.0 APPLICATION

Apply epoxy protective coating only when the air temperature is a least 40°F and rising, but less than 95°F and the surface temperature of the area to be coated is at least 40°F. Remove any excess or free standing water from the surface before applying the coating. Apply one coat of epoxy protective coating at a rate such that it covers between 100 and 200 square feet per gallon.

Under certain combinations of circumstances, the cure epoxy protective coating may develop an oily condition on the surface due to amine blush. This condition is not detrimental to the applied system.

Apply the coating so the entire designated surface of the concrete is covered and all pores are filled. To provide a uniform appearance, use the exact same material on all visible surface.

### 4.0 BASIS OF PAYMENT

*Epoxy Coating* will be measured and paid for by the contract unit price per square foot and shall be full compensation for furnishing all material, labor, tools and equipment necessary for cleaning and coating the tops of bent caps. Debris removal from the top of bent caps shall be incidental to epoxy coating the top of bent caps.

**BP-42**

Project I-5711

Alamance County

**OVERLAY SURFACE PREPARATION FOR  
POLYESTER POLYMER CONCRETE****(SPECIAL)****DESCRIPTION**

This special provision addresses the surface preparation activities required prior to the placement of polyester polymer concrete (PPC). Unless specifically mentioned below, all requirements specified for the bridge deck are also required for the approach slabs.

**Left and Right Widening:**

Work includes: bridge deck surface preparation that includes shotblasting prior to placement of PPC overlay; and any incidentals necessary to prepare the bridge deck for placement of PPC overlay, as specified or as shown on the widening plans.

**Existing Bridge:**

Work includes: removal of unsound and sound bridge deck concrete and existing patches in deck repair areas; preparation of repair areas prior to placement of PPC bridge deck repair material; bridge deck surface preparation prior to placement of PPC overlay; and any incidentals necessary to prepare the bridge deck for placement of PPC repair material or PPC overlay, as specified or as shown on the preservation plans.

**DEFINITIONS**

Scarification shall consist of the removal of any asphalt wearing surface and concrete surface to the uniform depth and limits shown on the plans.

Shotblasting shall consist of steel beads (or other materials as approved by the Engineer) “shot” out of a machine onto the bridge concrete deck concrete floor to remove soft or deteriorated concrete, and to clean the concrete deck surface for the application of the PPC overlay. Contractor shall vary the speed of the shotblaster or make multiple passes, as necessary, to achieve the required surface preparation for the PPC overlay. Areas inaccessible with shotblasting equipment may require surface preparation with sandblasting equipment and hand equipment.

**EQUIPMENT**

All equipment for cleaning the existing concrete surface and mixing and applying the overlay system shall be in accordance with the System Provider’s recommendations, as approved by the Engineer prior to commencement of any work:

- (A) Scarifying equipment that is a power-operated, mechanical grinder capable of removing a minimum depth of ¼” for each pass.
- (B) Shotblasting and sandblasting equipment to adequately prepare the bridge deck substrate, as required in this special provision. Provide equipment to supply oil-free and moisture-free compressed air for final surface preparation.
- (C) Equipment capable of sawing concrete to the specified plan depth.
- (D) Power driven hand tools for removal of unsound concrete are required that meet the following requirements:

## BP-43

Project I-5711

Alamance County

- (1) Pneumatic hammers weighing a nominal 15 lbs. or less.
  - (2) Pneumatic hammer chisel-type bits that do not exceed the diameter of the shaft in width.
- (E) Hand tools, such as hammers and chisels, for removal of final particles of unsound concrete.
- (F) Self-propelled vacuum capable of picking up dust and other loose material from prepared deck surface.
- (G) Equipment to supply oil-free and moisture-free compressed air for final surface preparation.

The equipment must operate at a noise level less than 90 decibels at a distance of 50 feet.

### MANAGEMENT AND DISPOSAL OF CONCRETE DEBRIS

All concrete debris shall become the property of the Contractor. The contractor shall be responsible for disposing of all debris generated by scarification, shotblasting, sandblasting, and any other surface preparation operations, in compliance with applicable regulations concerning such disposal.

All costs associated with management and disposal of all debris shall be included in the payment of other items.

### OSP PLAN SUBMITTAL

Prior to beginning surface preparation activities, the Contractor shall submit for review and approval the Overlay Surface Preparation (OSP) Plan. The OSP Plan shall detail the type of equipment that is intended to be used and the means by which the Contractor will achieve the following requirements:

- (A) Estimate depth of reinforcing steel.
- (B) Scarification of deck to depth required.
- (C) Measure depth of scarification to show completed within limits.
- (D) Measure depth of shotblasting to show completed within limits.

### SURFACE PREPARATION

Prior to any construction, take the necessary precautions to ensure debris from bridge deck preparation and repairs is not allowed to fall below the bridge deck.

Remove all existing asphalt overlays and all loose, disintegrated, unsound or contaminated concrete to the limits shown on the plans with the following requirements.

During surface preparation, precaution shall be taken to assure that traffic is protected from rebound, dust, and construction activities. Appropriate shielding shall be provided as required and directed by the Engineer. During surface preparation, the Contractor shall provide suitable coverings, as needed to protect all exposed areas not to receive overlay, such as curbs, sidewalks, parapets, etc. All damage or defacement resulting from surface preparation shall be repaired to the Engineer's satisfaction at no additional cost to the Department.

## BP-44

Project I-5711

Alamance County

- (A) Sealing of Bridge Deck: Seal all expansion joints subject to run-off water from the scarification, shotblasting, and PPC placement process with material approved by the Engineer, prior to beginning any demolition. The expansion joints shall remain sealed until it has been determined that water and materials from the scarification, shotblasting, and PPC placement operations cannot be discharged through them any longer. Take all steps necessary to eliminate the flow of water or materials through the expansion joints, and any other locations water or materials could leak from the deck.

All deck drains in the immediate work area and other sections of the bridge affected by the work being performed shall be sealed prior to beginning scarification. Drains shall remain sealed until it has been determined that water and materials from the scarification, shotblasting, and PPC placement operations cannot be discharged through them any longer.

- (B) Scarifying Bridge Deck: Remove any asphalt wearing surface from the bridge deck and scarify the concrete deck to remove the entire concrete surface of the deck to the uniform depth and limits shown on the plans.

It will be the Contractor's responsibility to determine amount of cover for the reinforcing steel. Use a pachometer or other approved device, as approved by Engineer, prior to scarification. Readings shall be read and recorded in the presence of the Engineer. Readings shall be recorded for each span at 1/5 points longitudinally and 1/3 points transversely. The cost for this work will be considered incidental to the cost of surface preparation of the bridge deck.

**Estimated average cover to top mat:**

**Bridge Number: 177 +/-2 1/4"**

The above top mat cover dimensions are an estimate based on the best available information. Calibrate scarifying equipment in order to avoid damaging the reinforcing steel in the bridge floor or the approach slab. Care shall be taken not to cut, stretch, or damage any exposed reinforcing steel. If reinforcing bars or bridge drainage devices are pulled up or snagged during scarification operations, cease work and consult with the Engineer to determine any necessary adjustments to the roto-milling operation.

Remove and dispose of all concrete and asphalt, and thoroughly clean the scarified surface. In areas where reinforcing steel is located in the depth to be scarified, use another method with the Engineer's approval.

The Engineer will re-inspect after each removal and require additional removals until compliance with plans and specifications are met.

Regardless of the method of removal, the removal operation shall be stopped if it is determined that sound concrete is being removed to a depth greater than required by the plans.

- (C) Class II Surface Preparation (Partial Depth): At locations specified on the plans or identified by the Engineer for Class II Surface Preparation, verify the depth of removal achieved by the scarification. Remove by additional scarification or chipping with hand tools all existing patches and unsound concrete. No additional payment will be made for Class II Surface Preparation depths achieved by the initial scarification.

## BP-45

Project I-5711

Alamance County

All patches shall be removed under Class II Surface Preparation. If any patch cannot be removed by means of scarification, the Contractor shall use hand tools to remove the patch. Areas indicated on the plans that require Class II Surface Preparation, including the locations of existing patches, are from the best information available. The Contractor shall verify prior to surface preparation the location of all existing patches.

Spalled or unsound areas of the deck not removed by scarification shall be removed to sound concrete at locations noted in the contract plans or as directed by the Engineer. Remove existing spalled or unsound areas of the bridge concrete deck by methods approved by the Engineer.

Provide a 1" deep saw cut around the perimeter of areas noted for bridge deck or patch removal. Remove, using the type of tools listed above, all concrete or patch material within the sawcut to a minimum depth of 1" and as necessary to remove unsound concrete. All loose and unsound concrete or patch material shall be removed.

If the condition of the concrete is such that deep spalls or sheer faces result, notify the Engineer for the proper course of action.

Thoroughly clean the newly exposed surface to be free of all grease, oil, curing compounds, acids, dirt, or loose debris in accordance with this special provision.

Dispose of the removed concrete, clean, repair or replace rusted or loose reinforcing steel, and thoroughly clean the newly exposed surface. Care shall be taken not to cut, stretch, or damage any exposed reinforcing steel.

In overhangs, removing concrete areas of less than 0.60 ft<sup>2</sup>/ft length of bridge without overhang support is permitted unless the Engineer directs otherwise. Overhang support is required for areas removed greater than 0.60 ft<sup>2</sup>/ft length of bridge. Submit details of overhang support to the Engineer for approval prior to beginning the work.

(D) Preparation of Reinforcing Steel: Remove concrete without cutting or damaging existing steel unless otherwise noted in the plans. Clean, repair, or replace rusted or loose reinforcing steel. Damaged reinforcing steel, such as bars with nicks deeper than 20% of the bar diameter, shall be repaired or replaced. Reinforcing steel which has a cross section reduced to 75% or less shall be replaced with new reinforcing steel of similar cross section area. Replacement bars shall be Grade 60 and meet the material requirements of Section 1070 of the *Standard Specifications*. Replacement bars shall be spliced to existing bars using either minimum 30 bar diameter lap splices to existing steel with 100% cross sectional area or approved mechanical connectors.

For reinforcing steel left unsupported by the concrete removal process, support and protect the exposed reinforcing steel against displacement and damage from loads, such as those caused by removal equipment and delivery buggies. All reinforcing steel damaged or dislodged by these operations shall be replaced with bars of the same size at the contractor's expense.

Reinforcing steel exposed and satisfactorily cleaned and prepared will not require additional cleaning, if encased in concrete within seven (7) days. Rebar exposed for more than seven (7) days shall be satisfactorily cleaned and prepared, prior to placement of the new concrete. The satisfactory cleanliness and preparation of the reinforcing steel shall be determined by the Engineer.

## BP-46

Project I-5711

Alamance County

When large areas of the deck on composite bridges are removed resulting in the debonding of the primary reinforcing bars, the removal shall be performed in stages to comply with the construction sequence shown on the plans or as directed by the Engineer.

(E) Concrete Deck Repair: Repair and fill the Class II Surface Preparation areas of the existing bridge concrete deck prior to the final surface preparation and application of the PPC overlay, at locations shown in the plans, or as determined by the Engineer, if necessary. Materials other than PPC may be used for concrete deck repairs, but shall be approved by the PPC System Provider's Technical Representative and shall be applied and prepared as required by the PPC System Provider. For concrete deck repairs with PPC:

- (1) Removal and surface preparation of the repair area shall be in accordance with and shall be paid for under pay items in this special provision.
- (2) Materials, equipment, placement, and finishing of PPC used for concrete deck repairs shall meet the requirements of and shall be paid for under pay items in the Polyester Polymer Concrete Bridge Deck Overlay special provision.

PPC repair material may be placed up to one (1) hour prior to overlay placement.

All repairs shall be placed and finished to match substrate deck grade prior to PPC placement, in order to provide a uniform overlay thickness.

Concrete deck repairs with PPC may be utilized as a stand-alone item where required on structures not to receive a PPC overlay.

(F) Surface Cleaning: The surface of concrete substrate and repaired areas shall be prepared for application of the overlay by shotblasting in order to remove all existing grease, slurry, oils, paint, dirt, striping, curing compound, rust, membrane, weak surface mortar, or any other contaminants that could interfere with the proper adhesion of the overlay system. The final prepared surface shall adhere to the following requirements:

- (1) If expansion joints are not being replaced or have been replaced prior to shotblasting they shall be protected from damage from the shotblasting operation. Deck drains and areas of curb or railing above the proposed surface shall be protected from the shotblasting operation.
- (2) The areas to receive overlay shall be cleaned by shotblasting, or abrasive sandblasting in the event that the shotblaster cannot access areas to be prepared. Do not begin shotblasting until all grinding or milling operations are completed. Cleaning shall not commence until all work involving the repair of the concrete deck surface has been completed and the deck is dry. All contaminants shall be picked up and stored in the vacuum unit and no dust shall be created during the blasting operation that will obstruct the view of motorists in adjacent roadways. The travel speed and/or number of passes of the shotblasting unit shall be adjusted, so as to result in all weak or loose surface mortar being removed, aggregates within the concrete being exposed, and open pores in the concrete exposed, as well as a visible change in the concrete color. Cleaned surfaces shall not be exposed to vehicular traffic unless approved by the Engineer. If the deck becomes contaminated before placing the overlay, the Contractor shall shotblast or abrasive sandblast the contaminated areas to the satisfaction of the Engineer at no additional cost to the Department.



**BP-47**

Project I-5711

Alamance County

- (3) Prior to the overlay placement, any loose particles shall be removed by magnets, oil free compressed air, and vacuuming, such that no trapped particles remain. Power washing will not be allowed.
- (4) The areas to be overlaid shall be blown off with oil and moisture free compressed air just prior to placement of the primer and shall be completely dry.
- (5) Cleaning methods other than those detailed by specification may be suggested by the PPC System Provider and approved by the Engineer.
- (6) All steel surfaces that will be in contact with the PPC overlay shall be cleaned in accordance with Structural Steel Paint Council (SSPC) Surface Preparation(SP) No. 10, Near-White Blast Cleaning, except that wet blasting methods shall not be allowed.
- (G) Safety: Provide a containment system for handling expected and unexpected blow through of the deck. The containment system shall retain runoff water and debris and protect the area under the bridge deck. The Contractor shall be responsible for any injury or damage caused by these operations. The containment system shall remain in place until the concrete has been cast and attained minimum strength.

Provide adequate lighting when performing deck preparation activities at night. Submit a lighting plan to the Engineer for approval prior to beginning work.

**MEASUREMENT AND PAYMENT**

*Scarifying Bridge Deck* will be measured and paid for at the contract unit price per square yard and will be full compensation for the milling of existing asphalt wearing surface from the bridge deck and approaches, milling of the entire concrete bridge deck, repairing or replacing any damaged reinforcing steel, and the cleaning and disposal of all waste material generated.

*Shotblasting Bridge Deck* will be measured and paid for at the contract unit price per square yard and will be full compensation for the shotblasting and necessary sandblasting and handwork to prepare the entire concrete bridge deck and approaches, and removal and disposal of all waste material generated.

*Class II Surface Preparation* will be measured and paid for at the contract unit price per square yard and will be full compensation for Class II deck preparation where required by the plans. The cost will also include removal and disposal of unsound and contaminated concrete, removal of all existing patches, cleaning, repairing, or replacing of reinforcing steel, and all materials, labor, tools, equipment and incidentals necessary to complete the work.

Payment will be made under:

**Pay Item**

Scarifying Bridge Deck  
Shotblasting Bridge Deck  
Class II Surface Preparation

**Pay Unit**

Square Yard  
Square Yard  
Square Yard

# BP-48

Project I-5711

Alamance County

## **POLYESTER POLYMER CONCRETE BRIDGE DECK OVERLAY** (SPECIAL)

### **DESCRIPTION**

This work consists of furnishing and placing a Polyester Polymer Concrete (PPC) overlay system with a High Molecular Weight Methacrylate (HMWM) resin primer on concrete surfaces. The surface of the concrete shall be prepared and the PPC overlay system shall be applied in accordance with this special provision in conformity with the lines, grades, thickness, and typical cross-sections shown on the plans or as approved by the Engineer. Unless specifically mentioned below, all requirements specified for the bridge deck are also required for the approach slabs.

Work includes: placement of HMWM primer; placement of PPC surface patching and/or overlay; and any incidentals necessary to complete the project as specified or as shown on the plans.

The System Provider is the manufacturer that will provide the PPC system for the PPC overlay. The System shall include the necessary and appropriate PPC components, as well as the necessary and appropriate HMWM resin primer components. Contractor shall not change System Provider during project, without approval from the Engineer.

### **QUALIFICATIONS AND SUBMITTALS**

The Contractor shall submit the following requested items and any other relevant documents at least two (2) weeks prior to the PPC Overlay Pre-placement Conference. These submittals are for approval and shall be directed to the Engineer.

(A) Overlay System: The Contractor shall submit two (2) copies of the System Provider's material information, written installation instructions, safety data sheets, and independent test results for approval.

(B) System Provider Qualifications: The Contractor shall install an overlay system with all components provided through a single System Provider with documented experience successfully supplying at least five (5) PPC overlay projects of similar size and scope within the past five (5) years. The Contractor shall submit documentation of the System Provider's project experience including the following:

- (1) Project Location.
- (2) Owner Agency.
- (3) Project construction date.
- (4) Overlay quantities.
- (5) Reference name and contact information for owner representative.

(C) Contractor Qualifications: The Contractor shall submit documentation of successful projects placing structural concrete bridge decks, modified concrete bridge deck overlays, or PPC overlay systems to finished grade using similar equipment as specified herein within the past five (5) years. A minimum of two (2) employees on site must have the equivalent work experience qualifications of the Contractor. The documentation of Contractors qualifications shall include the following:

**BP-49**

Project I-5711

Alamance County

- (1) Project Location.
- (2) Owner Agency.
- (3) Project construction date.
- (4) Overlay quantities.
- (5) Reference name and contact information for owner representative.

(D) System Provider Technical Representative Qualifications: The System Provider Technical Representative shall have a minimum of five (5) years of experience with PPC and be completely competent in all aspects of the work, including surface preparation, mixing, placement, curing, and testing of the PPC Overlay System. The Technical Representative shall have experience on a minimum of five (5) successful projects of similar size and scope. The Contractor shall submit documentation of the System Provider Technical Representative's experience including the following:

- (1) Years of Experience with PPC
- (2) Project location
- (3) Project construction date
- (4) Overlay quantities
- (5) Reference name and contact information for owner representative

The Technical Representative shall be available on site, for a minimum of three (3) days per project, to give the installer advice and guidance on the installation of PPC. This includes, but not limited to: deck concrete surface preparation, PPC materials, PPC application, PPC curing or any time there are questions or issues that may arise. The Technical Representative shall be on site for the first PPC overlay placement and shall remain on site until the Engineer is satisfied.

(E) Overlay Placement Plan: The Contractor shall submit an Overlay Placement Plan that includes the following:

- (1) Schedule of overlay work and testing for each bridge.
- (2) Anticipated concrete deck repair locations and repair method.
- (3) Staging plan describing overlay placement sequence including:
  - (a) Construction joint locations. Longitudinal construction joints between passes shall be located along the centerline of travel lanes or edge of travel lanes.
  - (b) Sequence of placement.
  - (c) Placement widths.
  - (d) Anticipated placement lengths.
  - (e) Placement direction.
  - (f) Joint locations.
  - (g) Location of proposed trial overlay(s).
- (4) Description of equipment used for:
  - (a) Surface preparation including grinding and shotblasting.
  - (b) Applying HMWM primer resin.

## BP-50

Project I-5711

Alamance County

- (c) Measuring, mixing, placing, and finishing the PPC.
  - (d) Applying surface finish sand.
  - (5) Method of protecting and finishing inlets and bridge drains.
  - (6) Method for isolating expansion joints.
  - (7) Method for measuring and maintaining overlay thickness and profile.
  - (8) Cure time for PPC.
  - (9) Storage and handling of HMWM resin and PPC components.
  - (10) Procedure for disposal of excess HMWM resin, PPC, and containers.
  - (11) Procedure for cleanup of mixing and placement equipment.
- (F) Equipment: The Contractor shall submit documentation of current certification that mixing equipment has been calibrated (Caltrans California test CT 109 or similar accepted). The Contractor shall submit a documented history of the use of the placement equipment to successfully place PPC overlays on bridge projects for review and approval by the Engineer.

### MATERIALS

The PPC shall consist of polyester resin binder and aggregate as specified below. It shall also include a compatible primer which when mixed with other specified ingredients and applied as specified herein, is capable of producing a PPC meeting the requirements of this specification.

- (1) Verification. The Contractor shall submit a Certified Test Report from independent labs for all of the materials associated with the PPC overlay in accordance with this special provision.
  - (2) Packaging and Shipment. All components shall be shipped in strong, substantial containers, bearing the manufacturer's label specifying batch/lot number, brand name, and quantity. If bulk resin is to be used, the contractor shall notify the Engineer in writing ten (10) working days prior to the delivery of the bulk resin to the job site. Bulk resin is any resin that is stored in containers in excess of 55 gallons.
  - (3) Sampling. NCDOT reserves the right to retain and test samples of components of the PPC overlay system. This includes requiring submittal of samples prior to the first installation or on-site sampling during construction.
- (A) Polyester Resin Binder: Polyester resin binder shall have the following properties:
- (1) Be an unsaturated isophthalic polyester-styrene co-polymer. The resin content shall be 12% +/-1% of the weight of the dry aggregate.
  - (2) Contain at least 1 percent by weight gamma-methacryloxypropyltrimethoxysilane, an organosilane ester silane coupler.
  - (3) Be used with a promoter that is compatible with suitable methyl ethyl ketone peroxide and cumene hydroperoxide initiators.
  - (4) Meet the required values for the material properties shown in Table 1, below.

Accelerators or inhibitors may be required to achieve proper setting time of PPC. They shall be used as recommended by the overlay System Provider.

**BP-51**

Project I-5711

Alamance County

**Table 1**  
**POLYESTER RESIN BINDER PROPERTIES**  
**(Each lot sent to job shall be tested)**

<b>Property</b>	<b>Test Method</b>	<b>Requirement</b>
Viscosity*	ASTM D 2196	75 – 200 cps (RVT No.1 Spindle, 20 RPM at 77 °F)
Specific Gravity*	ASTM D 1475	1.05 to 1.10 at 77 °F
Elongation	ASTM D 638	35 percent, minimum Type I specimen, thickness 0.25 ± 0.03” at Rate = 0.45 inch/minute.
	ASTM D 618	Sample Conditioning: 18/25/50+5/70
Tensile Strength	ASTM D 638	2,500 psi, minimum Type I specimen, thickness 0.25 ± 0.03” at Rate = 0.45 inch/minute.
	ASTM D 618	Sample Conditioning: 18/25/50+5/70
* Test shall be performed before adding initiator.		

- (B) High Molecular Weight Methacrylate (HMWM) Primer: Primer for the substrate concrete surface shall be a wax-free, low odor, high molecular weight methacrylate primer, and consist of a resin, initiator, and promoter. The primer shall conform to requirements indicated in Table 2, below, and all components shall be supplied by the System Provider.

Initiator for the methacrylate resin shall consist of a metal drier and peroxide. If supplied separately from the resin, the metal drier shall not be mixed with the peroxide directly; a VIOLENT EXOTHERMIC REACTION will occur. The containers and measuring devices shall not be stored in a manner that allows leakage or spilling to contact the containers or materials of the other.

**Table 2**  
**HIGH MOLECULAR WEIGHT METHACRYLATE RESIN PROPERTIES**  
**(Tested yearly)**

<b>Property</b>	<b>Test Method</b>	<b>Requirement</b>
Viscosity**	ASTM D 2196	25 cps maximum (Brookfield RVT with UL adapter, 50 RPM at 77 °F)
Volatile Content**	ASTM D 2369	30 percent, maximum
Specific Gravity**	ASTM D 1475	0.90 minimum at 77 °F
Flash Point	ASTM D 3278	180 °F minimum
Vapor Pressure**	ASTM D 323	1.0 mm Hg, maximum at 77 °F
PCC Saturated Surface-Dry Bond Strength (Adhesive)	California Test 551, part 5	700 psi, minimum at 24 hours and 70 ± 1°F (with PPC at 12% resin content by weight of the dry aggregate), primed surface
**Test shall be performed before initiator is added		

**BP-52**

Project I-5711

Alamance County

(C) Aggregates: PPC aggregate shall have the following properties:

- (1) No more than 45 percent crushed particles retained on the No. 8 sieve when tested in accordance with American Association of State Highway and Transportation Officials (AASHTO) Test Method T335.
- (2) Fine aggregate consists of natural sand only.
- (3) Weighted-average aggregate absorption of no more than 1.0 percent when tested under AASHTO Test Methods T84 and T85.
- (4) At the time of mixing with resin, have moisture content of not more than one-half ( $\frac{1}{2}$ ) of the weighted-average aggregate absorption when tested under AASHTO Test Method T255.
- (5) Moh's hardness of seven (7) or greater.
- (6) Comply with the requirements for the aggregate gradation indicated in Table 3, below:

**Table 3**  
**AGGREGATE GRADATION**  
**(Tested yearly)**

<b>Sieve Size</b>	<b>Percent Passing</b>
3/8"	100
No. 4	60-85
No. 8	55-65
No. 16	29-50
No. 30	16-36
No. 50	5-20
No. 100	0-7
No. 200	0-3

(D) Sand: Sand for abrasive sand finish shall have the following properties:

- (1) Commercial-quality blast sand.
- (2) Not less than 95 percent pass the No. 8 sieve and not less than 95 percent retained on the No. 20 sieve when tested under AASHTO Test Method T27.
- (3) Shall be dry at the time of application.

**BP-53**

Project I-5711

Alamance County

- (E) Composite system: The composite PPC system shall have the following properties indicated in Table 4, below:

**Table 4**  
**COMPOSITE PROPERTIES**  
**(Tested every 2 years)**

<b>Property</b>	<b>Test Method</b>	<b>Requirement</b>
PCC Saturated Surface Dry Bond Strength	CT 551	500 psi minimum at 24 hrs. and 70° F (without primer, at 12% resin content by weight of the dry aggregate, on Saturated Surface Dry Specimen)
Abrasion Resistance	CT 550	<2g weight loss (at 12% resin content by weight of the dry aggregate)
Modulus of Elasticity	ASTM C 469	1,000,000 psi to 2,000,000 psi (at 12% resin content by weight of the dry aggregate)

**CONSTRUCTION REQUIREMENTS**

- (A) PPC Overlay Pre-placement Conference: A Pre-placement Conference shall be held before any overlay operations begin. Attendees shall include representatives from all parties involved in the work. If necessary, teleconferencing of attendees may be approved by the Engineer.
- (B) Trial Application: Prior to constructing the overlay, one or more trial applications shall be placed on a previously constructed concrete base to demonstrate proper initial set time and the effectiveness of the mixing, placing, and finishing equipment proposed. The set time can be determined as the time elapsed from resin catalyzation until the in-place PPC cannot be deformed by pressing with a finger, indicating the resin binder is no longer in a liquid state. Each trial application shall be the planned paving width, at least ten (10) feet long, and the same thickness as the specified overlay. Conditions during the construction of the trial application(s) and equipment used shall be similar to those to be used for construction of the overlay. The location of the trial application(s) shall be approved by the Engineer. Trial applications shall be properly disposed of off-site by the Contractor, if removal is necessary.

The number of trial applications required shall be as many as necessary for the Contractor to demonstrate the ability to construct an acceptable trial overlay section and competency to perform the work. However, the installer or proposed equipment/techniques may be rejected if not shown to be acceptable after three (3) trials.

Overlay direct tension bond testing shall be performed in accordance with Section (F)(1) of this special provision. Acceptable test results shall be achieved on a trial application before the installation may proceed.

- (C) Equipment: All equipment for cleaning the existing concrete surface and mixing and applying the overlay system shall be in accordance with the System Provider's recommendations, as approved by the Engineer prior to commencement of any work.

**BP-54**

Project I-5711

Alamance County

- (1) Surface Preparation Equipment: Provide appropriate scarifying, shotblasting, sandblasting and other equipment to adequately prepare the bridge deck substrate, as required in the Overlay Surface Preparation for Polyester Polymer Concrete special provision.
- (2) Mixing Equipment: A continuous automated mixer shall be used for all PPC overlay applications. The continuous mixer shall:
  - (a) Employ an auger screw/chute device capable of sufficiently mixing catalyzed resin with dry aggregate.
  - (b) Employ a plural component pumping system capable of handling polyester binder resin and catalyst while maintaining proper ratios to achieve set/cure times within the specified limits. Catalyzed resin shall flow through a static mix tube for sufficient duration to completely mix the liquid system.
  - (c) Be equipped with an automatic metering device that measures and records aggregate and resin volumes. Record volumes at least every five (5) minutes, including time and date. Submit recorded volumes at the end of the work shift to the Engineer.
  - (d) Have a visible readout gage that displays volumes of aggregate and resin being recorded.
  - (e) Produce a satisfactory mix consistently during the entire placement.

A portable mechanical mixer of appropriate size for proposed batches, as recommended by the System Provider and approved by the Engineer, may be used for all PPC patching applications and for smaller area overlay applications if approved by the Engineer.

- (3) Finishing Equipment: Finishing may be accomplished with a Self-Propelled Slip-Form Paving Machine or Vibratory Screed.
  - (a) Self-Propelled Slip-Form Paving Machine: A self-propelled slip-form paving machine, which is modified or specifically built to effectively place the PPC overlay in a manner that meets the objectives and requirements of the project, may be used for PPC overlay applications. The paving machine shall:
    - (i) Employ a vibrating pan to consolidate and finish the PPC.
    - (ii) Be fitted with hydraulically controlled grade automation to establish the finished profile. The automation shall be fitted with substrate grade averaging devices on both sides of the new placement; the device shall average 15 feet in front and behind the automation sensors; or the sensor shall be constructed to work with string-line control. It is acceptable to match grade when placing lanes adjacent to previously placed PPC.
    - (iii) Be calibrated for the projects requirements, and calibrated periodically following the manufacturers recommendations.
    - (iv) Have sufficient engine power and weight to provide adequate vibration of the finishing pan while maintaining consistent forward placement speed.



**BP-55**

Project I-5711

Alamance County

(v) Be capable of both forward and reverse motion under its own power.

(b) Vibratory Screed: A vibratory screed may be used for finishing PPC, but must be approved by the Engineer at least two (2) weeks prior to PPC placement.

(D) Concrete Deck Repairs and Surface Preparation: All areas that require removal of existing patches or unsound concrete shall be removed and prepared in accordance with the requirements of the Overlay Surface Preparation for Polyester Polymer Concrete special provision. Placement of concrete for deck repair material shall be Polyester Polymer Concrete in accordance with this special provision. Prepare all concrete deck and repaired deck surfaces in accordance with the requirements of the Overlay Surface Preparation for Polyester Polymer Concrete special provision.

(E) Application of Overlay: Methods indicated in this special provision are typical of general installations and may be modified per the System Provider's recommendations as approved by the Engineer. The application of the overlay shall not begin until the concrete deck is completely surface dry in accordance with ASTM D4263, with a wait time revised from 16 hours to two (2) hours, or as directed by the System Provider's Technical Representative. The concrete surface temperature shall be between 40° and 100° F. Night work may be required when temperatures cannot be met during the day.

During overlay application, precaution shall be taken to assure that traffic is protected from rebound, dust, and construction activities. Appropriate shielding shall be provided as required and directed by the Engineer.

During overlay application, the Contractor shall provide suitable coverings (e.g. heavy duty drop cloths) as needed to protect all exposed areas not to receive overlay, such as curbs, sidewalks, parapets, etc. All damage or defacement resulting from this application shall be cleaned and/or repaired to the Engineer's satisfaction at no additional cost to the Department.

(1) HMWM Primer Application: Immediately before placing primer, all exposed surfaces shall be completely dry and blown clean with oil-free compressed air. Exposed surfaces shall be protected from precipitation and heavy dew during and after the application of the primer.

After the exposed surfaces have been prepared and are dry, primer shall be applied in accordance with the System Provider's recommendations. Primer shall be placed within five (5) minutes of mixing at approximately 90 ft<sup>2</sup>/ gal or the rate acceptable to the Engineer.

Primer shall be applied by flooding and uniformly spread to completely cover surfaces to receive overlay. Care shall be taken to avoid heavy application that results in excess ponding. Excess material shall be removed or distributed to meet the required application rate. Primer shall be reapplied to any areas that appear dry prior to overlay placement.

Primer shall not be allowed to leak onto areas that have not received surface preparation.

(2) PPC Application: The PPC shall be applied during the interval between 15 minutes and two (2) hours after the primer has been applied. The PPC shall be placed prior to gelling

## BP-56

Project I-5711

Alamance County

and within 15 minutes following addition of initiator, unless otherwise recommended by the System Provider's Technical Representative.

The polyester resin binder shall be initiated and blended completely. Aggregate shall be added and mixed sufficiently when a portable mechanical mixer is used.

PPC shall have an initial set time of at least 30 minutes and at most 90 minutes. The set time can be determined in the field when the in-place PPC cannot be deformed by pressing with a finger, indicating that the resin binder is no longer in a liquid state. If the initial set is not within 30 to 90 minutes, the material shall be removed and replaced.

The overlay shall be consolidated and finished to the required grade and cross-section using PPC placement equipment as defined herein.

If a vibratory screed is used, prior to placing the PPC, place and fasten screed rails in position to ensure finishing the new surface to the required profile. Do not treat screed rails with parting compound to facilitate their removal. Prior to placing the overlay, attach a filler block to the bottom of the screed and pass it over the overlay area to check the thickness. The filler block thickness shall be equal to the design overlay thickness as shown in the plans. Remove all concrete that the block does not clear.

Place the PPC in one operation. Provide a minimum overlay thickness as shown in the plans.

Although the paver or screed may yield a finished or nearly finished surface, additional finishing may be necessary. PPC shall be finished, as necessary, through traditional concrete finishing methods, producing a slight resin bleed indicating complete consolidation of aggregates.

Finishing of PPC used as patching of an existing deck surface or overlay shall be completed and finished using traditional concrete hand finishing methods and hand concrete finishing tools. Such patches shall be placed flush with the top of the existing deck surface.

Resin content shall be as specified in the Materials section of this special provision and to yield a PPC consistency that requires surface applied consolidation and finishing to consolidate aggregates and yield a slight sheen of bleed resin on top surface yet does not yield excess bleed resin.

A surface friction sand finish of at least 2.2 lbs/ yd<sup>2</sup> shall be broadcast onto the glossy surface immediately after sufficient finishing and before resin gelling occurs. To ensure adequate pavement friction, the completed PPC overlay surface shall be free of any smooth or "glassy" areas such as those resulting from insufficient quantities of surface aggregate. Any such surface defects shall be repaired by the Contractor in the manner recommended by the System Provider and approved by the Engineer at no additional cost to the Department.

After application of surface friction sand, unless otherwise indicated on the plans, groove the bridge floor in accordance with Subarticle 420-14(B) of the *Standard Specifications*. Vehicular traffic may travel across a deck surface that has not been grooved; however, the entire deck area shall be grooved after the PPC overlay achieves design strength and

## BP-57

Project I-5711

Alamance County

no later than seven (7) calendar days after completion of the overlay unless otherwise approved by the Engineer.

Before completion of the project, all deck joints shall be sawcut, prepared, and sealed according to the details in the plans.

After the PPC material has set, if final sawcutting for joint seals will not be done within 12 hours, at minimum, a single sawcut shall be made at the approximate midpoint of each joint. The sawcut shall be made within 12 hours or prior to opening of PPC placement to traffic, if traffic will be allowed within 12 hours. Two (2) saw cuts may be made, but final saw cutting for the joints shall be done in accordance with the special provisions for the installation of the joint seals.

Any surface that is scarified shall be covered with the PPC overlay before traffic is returned to the bridge deck, unless otherwise approved by the Engineer.

Upon approval by the Engineer, if traffic is to be returned to the site, but the overlay is not completed within the allowable lane closure time and is more than  $\frac{3}{4}$  inch higher in elevation than the adjacent pavement, the PPC overlay edges shall be tapered. The leading edge of the overlay shall be tapered at a 4:1 (horizontal: vertical) slope. Tapered edges longitudinal to the direction of traffic and tapered edges on the trailing edge of the overlay and shall be at a 45 degree slope. Tapers of 45 degrees may remain, and PPC overlay may be placed adjacent. Tapers with a 4:1 (horizontal: vertical) slope shall be sawcut square to the overlay surface, prior to placing adjacent PPC overlay.

The Contractor shall collect a ticket for each pass or portion of a pass that is provided by each mixer, and ensure that the following information is shown on each ticket:

- (a) Project Number.
- (b) Bridge Number.
- (c) Date and Time.
- (d) Location of Placement (Lane and Station Limits or location and length of placement along the length of the bridge).
- (e) Aggregate Weight.
- (f) Polyester Resin Binder Weight.

The tickets shall be available on site for Inspection personnel to use in tabulating quantities.

Curing: The Contractor shall allow the overlay to cure sufficiently before subjecting it to loads or traffic of any nature that may damage the overlay. Cure time depends upon the ambient and deck temperatures as well as initiator/accelerator levels.

The overlay shall be considered cured to a traffic ready state when a minimum reading of 25 on a properly calibrated Swiss hammer is achieved. Other rebound hammers may be use as approved by the Engineer.

- (F) Acceptance Testing: Acceptance of the deck repairs, surface preparation, and PPC overlay will be determined by the Engineer based on vertical axis bond tests, and smoothness quality testing performed by the Engineer, assisted by the Contractor.

## BP-58

Project I-5711

Alamance County

- (1) Overlay Direct Tension Bond Testing: Direct tension bond (pull-off) tests shall be performed after 24 hours by the Contractor in accordance to ASTM C1583. At a minimum, three (3) direct tension bond tests shall be performed on each bridge overlay. For bridges with deck areas greater than 25,000 square feet, additional tests shall be performed at a frequency of one test per 25,000 square feet of additional deck area, rounded up. Additional testing may be required as directed by the Engineer.

The test result shall be the average of the tests for each structure. Test cores shall be drilled a minimum of ½” below the bond line.

The average minimum bond strength of the PPC overlay system on normal weight concrete shall be 250 psi, with no individual test measured below 225 psi. An acceptable test will demonstrate that the overlay bond strength is sufficient by producing a concrete subsurface failure area greater than 50% of the test surface area, at a minimum depth of ¼”. The Contractor shall repair all direct tension test locations with PPC overlay in accordance with this special provision.

Direct tension bond testing shall be performed by an independent testing firm and shall be arranged by the Contractor. The Contractor may perform the direct tension bond testing with the approval of the Engineer. Testing shall be performed using a calibrated tensile loading device, in the presence of the Engineer. The tensile loading device shall be calibrated annually. The cost of direct tension bond testing shall be included in the bid price for *Placing and Finishing PPC Overlay* item.

- (2) Smoothness Quality Testing: As soon as practical after the PPC has hardened sufficiently, the Contractor shall test the finished surface with an approved rolling straightedge that is designed, constructed, and adjusted, so that it will accurately indicate or mark all deck areas which deviate from a plane surface by more than ⅛” in 10’. The Contractor shall remove all high areas in the hardened surface in excess of ⅛” in 10’ with an approved grinding or cutting machine. Additionally, the final PPC deck surface shall not deviate from the line and elevation indicated on the plans by more than 0.3” over any 50’ length. If approved by the Engineer, correct low areas in an acceptable manner.

### (G) Corrective Work

- (1) Repair of Surface Defects: The repair materials and finishing methods for surface defects in the overlay shall be in accordance to those used for the application of the overlay. All surface defects shall be repaired to the satisfaction of the Engineer before acceptance of the work is made.
- (2) Correction for Smoothness: Areas showing high spots of more than ⅛” in 10’ shall be marked and ground until the high spot does not exceed ⅛” in 10’. Ground surface may be sawcut grooved to restore the texture if ordered by the Engineer. Areas showing low spots of more than ⅛” in 10’ shall be marked and a proposed repair procedure shall be submitted to the Engineer. The use of the proposed repair procedure shall be as recommended by the System Provider and approved by the Engineer.

**BP-59**

Project I-5711

Alamance County

- (3) Replacement of Defective Overlay: A defective overlay, or portion thereof, resulting in failing overlay pull bond test results shall be removed and replaced at the Contractor's expense. The Contractor shall submit a written corrective work proposal to the Engineer, which shall include the methods and procedures that will be used. The Contractor shall not commence corrective work until the methods and procedures have been approved in writing by the Engineer. The Engineer's approval shall not relieve the Contractor of the responsibility of producing work in conformity with the Contract.
- (4) Repair of Cracking: After a one-week cure period, if cracks are in the overlay, the Contractor shall fill the cracks with properly catalyzed and mixed HMWM primer material at no cost to the Department. Care shall be taken to fill the cracks only and ensure minimal HMWM primer is left on the finished surface of the overlay.

**MEASUREMENT AND PAYMENT**

*Concrete Deck Repair for Polyester Polymer Concrete Overlay* will be measured and paid for at the contract unit price bid per square yard and will be full compensation for placement of concrete deck repair material and shall include the cost of labor, tools, equipment and incidentals necessary to complete the work.

*Polyester Polymer Concrete Materials* will be measured as the actual volume of PPC material complete-in-place. The volume shall include material used for overlay, patching of existing unsound concrete deck surface or overlays, and bridge deck concrete repairs as directed by the Engineer. Tickets provided to the project inspector, showing quantities of PPC produced, shall be sufficient to calculate volume of material placed. Materials placed for trial application(s) shall be included in this Pay Item if placed and remaining on the bridge deck as part of the permanent overlay. *Polyester Polymer Concrete Materials* will be paid for at the contract unit price per cubic yard and will be full compensation to furnish the PPC material, including HMWM primer, freight to the project site, receiving, storage, and disposal of any unused PPC overlay material. Payment by cubic foot will be based on a 135 lbs/ ft<sup>3</sup> unit weight and quantities recorded by calibrated mixer unit readouts.

*Placing and Finishing Polyester Polymer Concrete Overlay* will be measured and paid for as the contract unit price bid per square yard of overlay placement and final surface finishing. Payment will be full compensation for all labor, equipment, and all incidentals necessary to complete the PPC overlay placement. Construction and removal (if required) of trial application(s), including concrete base surfaces, will not be measured and paid for separately, but shall be incidental to complete the work.

Payment will be made under:

**Pay Item**

Concrete Deck Repair for Polyester Polymer Concrete Overlay  
 Polyester Polymer Concrete Materials  
 Placing & Finishing Polyester Polymer Concrete Overlay

**Pay Unit**

Square Yard  
 Cubic Yard  
 Square Yard

County : Alamance

Line #	Item Number	Sec #	Description	Quantity	Unit Cost	Amount
<b>ROADWAY ITEMS</b>						
0001	0000100000-N	800	MOBILIZATION	Lump Sum	L.S.	
0002	0000400000-N	801	CONSTRUCTION SURVEYING	Lump Sum	L.S.	
0003	0030000000-N	SP	TYPE II MODIFIED APPROACH FILL, STATION ***** (27+02.26 -L-)	Lump Sum	L.S.	
0004	0036000000-E	225	UNDERCUT EXCAVATION	2,475 CY		
0005	0043000000-N	226	GRADING	Lump Sum	L.S.	
0006	0050000000-E	226	SUPPLEMENTARY CLEARING & GRUB- BING	1 ACR		
0007	0134000000-E	240	DRAINAGE DITCH EXCAVATION	25 CY		
0008	0195000000-E	265	SELECT GRANULAR MATERIAL	1,975 CY		
0009	0196000000-E	270	GEOTEXTILE FOR SOIL STABILIZA- TION	3,075 SY		
0010	0199000000-E	SP	TEMPORARY SHORING	140 SF		
0011	0255000000-E	SP	GENERIC GRADING ITEM HAULING & DISPOSAL OF PETRO- LEUM CONTAMINATED SOIL	60 TON		
0012	0318000000-E	300	FOUNDATION CONDITIONING MATE- RIAL, MINOR STRUCTURES	460 TON		
0013	0320000000-E	300	FOUNDATION CONDITIONING GEO- TEXTILE	1,420 SY		
0014	0343000000-E	310	15" SIDE DRAIN PIPE	1,024 LF		
0015	0344000000-E	310	18" SIDE DRAIN PIPE	124 LF		
0016	0345000000-E	310	24" SIDE DRAIN PIPE	280 LF		
0017	0348000000-E	310	*** SIDE DRAIN PIPE ELBOWS (15")	6 EA		
0018	0378000000-E	310	24" RC PIPE CULVERTS, CLASS III	44 LF		

County : Alamance

Line #	Item Number	Sec #	Description	Quantity	Unit Cost	Amount
0019	0448200000-E	310	15" RC PIPE CULVERTS, CLASS IV	1,956	LF	
0020	0448300000-E	310	18" RC PIPE CULVERTS, CLASS IV	240	LF	
0021	0448400000-E	310	24" RC PIPE CULVERTS, CLASS IV	584	LF	
0022	0995000000-E	340	PIPE REMOVAL	2,034	LF	
0023	1099500000-E	505	SHALLOW UNDERCUT	350	CY	
0024	1099700000-E	505	CLASS IV SUBGRADE STABILIZATION	650	TON	
0025	1220000000-E	545	INCIDENTAL STONE BASE	1,000	TON	
0026	1297000000-E	607	MILLING ASPHALT PAVEMENT, **** DEPTH (1-1/2")	21,400	SY	
0027	1297000000-E	607	MILLING ASPHALT PAVEMENT, **** DEPTH (3")	19,150	SY	
0028	1330000000-E	607	INCIDENTAL MILLING	2,110	SY	
0029	1491000000-E	610	ASPHALT CONC BASE COURSE, TYPE B25.0C	7,500	TON	
0030	1503000000-E	610	ASPHALT CONC INTERMEDIATE COURSE, TYPE I19.0C	5,100	TON	
0031	1519000000-E	610	ASPHALT CONC SURFACE COURSE, TYPE S9.5B	5,900	TON	
0032	1523000000-E	610	ASPHALT CONC SURFACE COURSE, TYPE S9.5C	1,200	TON	
0033	1524200000-E	610	ASPHALT CONC SURFACE COURSE, TYPE S9.5D	2,100	TON	
0034	1575000000-E	620	ASPHALT BINDER FOR PLANT MIX	1,195	TON	
0035	1577000000-E	620	POLYMER MODIFIED ASPHALT BINDER FOR PLANT MIX	120	TON	
0036	1693000000-E	654	ASPHALT PLANT MIX, PAVEMENT REPAIR	1,000	TON	

County : Alamance

Line #	Item Number	Sec #	Description	Quantity	Unit Cost	Amount
0037	1840000000-E	665	MILLED RUMBLE STRIPS (ASPHALT CONCRETE)	6,900 LF		
0038	2022000000-E	815	SUBDRAIN EXCAVATION	22.4 CY		
0039	2026000000-E	815	GEOTEXTILE FOR SUBSURFACE DRAINS	100 SY		
0040	2036000000-E	815	SUBDRAIN COARSE AGGREGATE	16.8 CY		
0041	2044000000-E	815	6" PERFORATED SUBDRAIN PIPE	100 LF		
0042	2070000000-N	815	SUBDRAIN PIPE OUTLET	1 EA		
0043	2077000000-E	815	6" OUTLET PIPE	6 LF		
0044	2264000000-E	840	PIPE PLUGS	0.029 CY		
0045	2286000000-N	840	MASONRY DRAINAGE STRUCTURES	64 EA		
0046	2308000000-E	840	MASONRY DRAINAGE STRUCTURES	2.4 LF		
0047	2363000000-N	840	FRAME WITH TWO GRATES, STD 840.***** (840.15)	6 EA		
0048	2364000000-N	840	FRAME WITH TWO GRATES, STD 840.16	6 EA		
0049	2365000000-N	840	FRAME WITH TWO GRATES, STD 840.22	1 EA		
0050	2374000000-N	840	FRAME WITH GRATE & HOOD, STD 840.03, TYPE ** (E)	8 EA		
0051	2374000000-N	840	FRAME WITH GRATE & HOOD, STD 840.03, TYPE ** (F)	25 EA		
0052	2374000000-N	840	FRAME WITH GRATE & HOOD, STD 840.03, TYPE ** (G)	24 EA		
0053	2451000000-N	852	CONCRETE TRANSITIONAL SECTION FOR DROP INLET	3 EA		



County : Alamance

Line #	Item Number	Sec #	Description	Quantity	Unit Cost	Amount
0054	2535000000-E	846	***X *** CONCRETE CURB (8" X 12")	30 LF		
0055	2549000000-E	846	2'-6" CONCRETE CURB & GUTTER	8,970 LF		
0056	2591000000-E	848	4" CONCRETE SIDEWALK	2,260 SY		
0057	2605000000-N	848	CONCRETE CURB RAMPS	54 EA		
0058	2612000000-E	848	6" CONCRETE DRIVEWAY	40 SY		
0059	2627000000-E	852	4" CONCRETE ISLAND COVER	140 SY		
0060	2647000000-E	852	5" MONOLITHIC CONCRETE ISLANDS (SURFACE MOUNTED)	140 SY		
0061	2655000000-E	852	5" MONOLITHIC CONCRETE ISLANDS (KEYED IN)	600 SY		
0062	2710000000-N	854	CONCRETE BARRIER TRANSITION SECTION	2 EA		
0063	2724000000-E	857	PRECAST REINFORCED CONCRETE BARRIER, SINGLE FACED	140 LF		
0064	2800000000-N	858	ADJUSTMENT OF CATCH BASINS	1 EA		
0065	3030000000-E	862	STEEL BEAM GUARDRAIL	700 LF		
0066	3045000000-E	862	STEEL BEAM GUARDRAIL, SHOP CURVED	175 LF		
0067	3145000000-E	862	EXTRA LENGTH GUARDRAIL POST (** STEEL) (8')	41 EA		
0068	3150000000-N	862	ADDITIONAL GUARDRAIL POSTS	5 EA		
0069	3195000000-N	862	GUARDRAIL END UNITS, TYPE AT-1	3 EA		
0070	3215000000-N	SP	GUARDRAIL ANCHOR UNITS, TYPE III	2 EA		
0071	3287000000-N	SP	GUARDRAIL END UNITS, TYPE TL-3	3 EA		

County : Alamance

Line #	Item Number	Sec #	Description	Quantity	Unit Cost	Amount
0072	3317000000-N	SP	GUARDRAIL ANCHOR UNITS, TYPE B-77	2 EA		
0073	3360000000-E	863	REMOVE EXISTING GUARDRAIL	605 LF		
0074	3503000000-E	866	WOVEN WIRE FENCE, 47" FABRIC	700 LF		
0075	3509000000-E	866	4" TIMBER FENCE POSTS, 7'-6" LONG	35 EA		
0076	3515000000-E	866	5" TIMBER FENCE POSTS, 8'-0" LONG	28 EA		
0077	3575000000-E	SP	GENERIC FENCING ITEM STEEL PIPE HANDRAIL	50 LF		
0078	3649000000-E	876	RIP RAP, CLASS B	30 TON		
0079	3656000000-E	876	GEOTEXTILE FOR DRAINAGE	1,425 SY		
0080	4048000000-E	902	REINFORCED CONCRETE SIGN FOUNDATIONS	2 CY		
0081	4054000000-E	902	PLAIN CONCRETE SIGN FOUNDATIONS	1 CY		
0082	4057000000-E	SP	OVERHEAD FOOTING	36 CY		
0083	4060000000-E	903	SUPPORTS, BREAKAWAY STEEL BEAM	1,886 LB		
0084	4066000000-E	903	SUPPORTS, SIMPLE STEEL BEAM	317 LB		
0085	4072000000-E	903	SUPPORTS, 3-LB STEEL U-CHANNEL	900 LF		
0086	4082100000-N	906	SUPPORTS, OVERHEAD SIGN STRUCTURE AT STA ***** (23+15 -L-)	Lump Sum	L.S.	
0087	4082100000-N	906	SUPPORTS, OVERHEAD SIGN STRUCTURE AT STA ***** (30+75 -L-)	Lump Sum	L.S.	
0088	4096000000-N	904	SIGN ERECTION, TYPE D	4 EA		
0089	4102000000-N	904	SIGN ERECTION, TYPE E	51 EA		

County : Alamance

Line #	Item Number	Sec #	Description	Quantity	Unit Cost	Amount
0090	4108000000-N	904	SIGN ERECTION, TYPE F	2	EA	
0091	4109000000-N	904	SIGN ERECTION, TYPE *** (OVER-HEAD) (A)	4	EA	
0092	4110000000-N	904	SIGN ERECTION, TYPE *** (GROUND MOUNTED) (A)	6	EA	
0093	4110000000-N	904	SIGN ERECTION, TYPE *** (GROUND MOUNTED) (B)	1	EA	
0094	4116100000-N	904	SIGN ERECTION, RELOCATE TYPE **** (GROUND MOUNTED) (GM RESTAURANT LOGO SIGNS)	1	EA	
0095	4149000000-N	907	DISPOSAL OF SIGN SYSTEM, OVER-HEAD	1	EA	
0096	4152000000-N	907	DISPOSAL OF SIGN SYSTEM, STEEL BEAM	2	EA	
0097	4155000000-N	907	DISPOSAL OF SIGN SYSTEM, U-CHANNEL	56	EA	
0098	4158000000-N	907	DISPOSAL OF SIGN SYSTEM, WOOD	2	EA	
0099	4192000000-N	907	DISPOSAL OF SUPPORT, U-CHANNEL	1	EA	
0100	4400000000-E	1110	WORK ZONE SIGNS (STATIONARY)	524	SF	
0101	4405000000-E	1110	WORK ZONE SIGNS (PORTABLE)	624	SF	
0102	4410000000-E	1110	WORK ZONE SIGNS (BARRICADE MOUNTED)	142	SF	
0103	4415000000-N	1115	FLASHING ARROW BOARD	6	EA	
0104	4420000000-N	1120	PORTABLE CHANGEABLE MESSAGE SIGN	6	EA	
0105	4422000000-N	1120	PORTABLE CHANGEABLE MESSAGE SIGN (SHORT TERM)	40	DAY	
0106	4430000000-N	1130	DRUMS	580	EA	

County : Alamance

Line #	Item Number	Sec #	Description	Quantity	Unit Cost	Amount
0107	4434000000-N	SP	SEQUENTIAL FLASHING WARNING LIGHTS	40 EA		
0108	4435000000-N	1135	CONES	60 EA		
0109	4445000000-E	1145	BARRICADES (TYPE III)	96 LF		
0110	4447000000-E	SP	PEDESTRIAN CHANNELIZING DEVICES	72 LF		
0111	4455000000-N	1150	FLAGGER	480 DAY		
0112	4465000000-N	1160	TEMPORARY CRASH CUSHIONS	7 EA		
0113	4470000000-N	1160	REMOVE & RESET TEMPORARY CRASH CUSHION	3 EA		
0114	4480000000-N	1165	TMA	4 EA		
0115	4485000000-E	1170	PORTABLE CONCRETE BARRIER	3,205 LF		
0116	4490000000-E	1170	PORTABLE CONCRETE BARRIER (ANCHORED)	1,150 LF		
0117	4505000000-E	1170	REMOVE & RESET PORTABLE CONCRETE BARRIER (ANCHORED)	410 LF		
0118	4600000000-N	SP	GENERIC TRAFFIC CONTROL ITEM AUDIBLE WARNING DEVICES	6 EA		
0119	4600000000-N	SP	GENERIC TRAFFIC CONTROL ITEM PEDESTRIAN TRANSPORT SERVICE (PER TRIP)	1,500 EA		
0120	4650000000-N	1251	TEMPORARY RAISED PAVEMENT MARKERS	570 EA		
0121	4685000000-E	1205	THERMOPLASTIC PAVEMENT MARKING LINES (4", 90 MILS)	13,979 LF		
0122	4688000000-E	1205	THERMOPLASTIC PAVEMENT MARKING LINES (6", 90 MILS)	10,248 LF		
0123	4695000000-E	1205	THERMOPLASTIC PAVEMENT MARKING LINES (8", 90 MILS)	3,397 LF		

County : Alamance

Line #	Item Number	Sec #	Description	Quantity	Unit Cost	Amount
0124	4700000000-E	1205	THERMOPLASTIC PAVEMENT MARKING LINES (12", 90 MILS)	995	LF	
0125	4720000000-E	1205	THERMOPLASTIC PAVEMENT MARKING CHARACTER (90 MILS)	12	EA	
0126	4725000000-E	1205	THERMOPLASTIC PAVEMENT MARKING SYMBOL (90 MILS)	99	EA	
0127	4726110000-E	1205	HEATED-IN-PLACE THERMOPLASTIC PAVEMENT MARKING SYMBOL (90 MILS)	24	EA	
0128	4770000000-E	1205	COLD APPLIED PLASTIC PAVEMENT MARKING LINES, TYPE ** (4") (II)	1,617	LF	
0129	4770000000-E	1205	COLD APPLIED PLASTIC PAVEMENT MARKING LINES, TYPE ** (4") (IV)	310	LF	
0130	4805000000-N	1205	COLD APPLIED PLASTIC PAVEMENT MARKING SYMBOL, TYPE ** (II)	10	EA	
0131	4805000000-N	1205	COLD APPLIED PLASTIC PAVEMENT MARKING SYMBOL, TYPE ** (IV)	2	EA	
0132	4810000000-E	1205	PAINT PAVEMENT MARKING LINES (4")	33,600	LF	
0133	4815000000-E	1205	PAINT PAVEMENT MARKING LINES (6")	33,000	LF	
0134	4820000000-E	1205	PAINT PAVEMENT MARKING LINES (8")	1,820	LF	
0135	4825000000-E	1205	PAINT PAVEMENT MARKING LINES (12")	400	LF	
0136	4835000000-E	1205	PAINT PAVEMENT MARKING LINES (24")	730	LF	
0137	4840000000-N	1205	PAINT PAVEMENT MARKING CHARACTER	36	EA	
0138	4845000000-N	1205	PAINT PAVEMENT MARKING SYMBOL	109	EA	

County : Alamance

Line #	Item Number	Sec #	Description	Quantity	Unit Cost	Amount
0139	4850000000-E	1205	REMOVAL OF PAVEMENT MARKING LINES (4")	5,200 LF		
0140	4855000000-E	1205	REMOVAL OF PAVEMENT MARKING LINES (6")	22,000 LF		
0141	4860000000-E	1205	REMOVAL OF PAVEMENT MARKING LINES (8")	800 LF		
0142	4870000000-E	1205	REMOVAL OF PAVEMENT MARKING LINES (24")	120 LF		
0143	4875000000-N	1205	REMOVAL OF PAVEMENT MARKING SYMBOLS & CHARACTERS	18 EA		
0144	4891000000-E	1205	GENERIC PAVEMENT MARKING ITEM THERMOPLASTIC PAVEMENT MARKING LINES (24", 90 MILS)	4,183 LF		
0145	4900000000-N	1251	PERMANENT RAISED PAVEMENT MARKERS	35 EA		
0146	4905000000-N	1253	SNOWPLOWABLE PAVEMENT MARKERS	351 EA		
0147	5070000000-N	SP	STANDARD FOUNDATION ***** (TYPE R1)	3 EA		
0148	5155000000-E	1409	ELECTRICAL DUCT, TYPE BD, SIZE ***** (2")	155 LF		
0149	5160000000-E	1409	ELECTRICAL DUCT, TYPE JA, SIZE ***** (3")	45 LF		
0150	5160000000-E	1409	ELECTRICAL DUCT, TYPE JA, SIZE ***** (4")	135 LF		
0151	5185000000-E	1410	** #2 W/G FEEDER CIRCUIT (2)	310 LF		
0152	5215000000-E	1410	** #4 W/G FEEDER CIRCUIT IN ***** CONDUIT (2, 1.5")	650 LF		
0153	5220000000-E	1410	** #2 W/G FEEDER CIRCUIT IN ***** CONDUIT (2, 1.5")	330 LF		

County : Alamance

Line #	Item Number	Sec #	Description	Quantity	Unit Cost	Amount
0154	5240000000-N	1411	ELECTRICAL JUNCTION BOXES ***** (IG18)	3 EA		
0155	5240000000-N	1411	ELECTRICAL JUNCTION BOXES ***** (LS18)	3 EA		
0156	5255000000-N	1413	PORTABLE LIGHTING	Lump Sum	L.S.	
0157	5260000000-N	SP	GENERIC LIGHTING ITEM LUMINAIRE STORAGE	Lump Sum	L.S.	
0158	5270000000-N	SP	GENERIC LIGHTING ITEM RELOCATE LIGHT STANDARD	1 EA		
0159	5270000000-N	SP	GENERIC LIGHTING ITEM REMOVE LIGHT STANDARD FOUNDATION	1 EA		
0160	5270000000-N	SP	GENERIC LIGHTING ITEM REMOVE SINGLE ARM LIGHT STANDARD	1 EA		
0161	5325800000-E	1510	8" WATER LINE	10 LF		
0162	5326200000-E	1510	12" WATER LINE	325 LF		
0163	5329000000-E	1510	DUCTILE IRON WATER PIPE FITTINGS	3,115 LB		
0164	5540000000-E	1515	6" VALVE	1 EA		
0165	5546000000-E	1515	8" VALVE	1 EA		
0166	5558000000-E	1515	12" VALVE	4 EA		
0167	5571000000-E	1515	*** TAPPING SLEEVE & VALVE (2")	1 EA		
0168	5648000000-N	1515	RELOCATE WATER METER	8 EA		
0169	5649000000-N	1515	RECONNECT WATER METER	2 EA		
0170	5653100000-E	1515	RELOCATE *** DCV BACKFLOW PRE- VENTION ASSEMBLY (1")	3 EA		

County : Alamance

Line #	Item Number	Sec #	Description	Quantity	Unit Cost	Amount
0171	5653100000-E	1515	RELOCATE *** DCV BACKFLOW PRE-VENTION ASSEMBLY (2")	3 EA		
0172	5672000000-N	1515	RELOCATE FIRE HYDRANT	3 EA		
0173	5673000000-E	1515	FIRE HYDRANT LEG	80 LF		
0174	5686000000-E	1515	*** WATER SERVICE LINE (1")	70 LF		
0175	5686000000-E	1515	*** WATER SERVICE LINE (2")	95 LF		
0176	5691200000-E	1520	6" SANITARY GRAVITY SEWER	10 LF		
0177	5691300000-E	1520	8" SANITARY GRAVITY SEWER	165 LF		
0178	5775000000-E	1525	4' DIA UTILITY MANHOLE	3 EA		
0179	5801000000-E	1530	ABANDON 8" UTILITY PIPE	134 LF		
0180	5828000000-N	1530	REMOVE UTILITY MANHOLE	2 EA		
0181	5882000000-N	SP	GENERIC UTILITY ITEM 12" INSERT VALVE	2 EA		
0182	6000000000-E	1605	TEMPORARY SILT FENCE	7,880 LF		
0183	6006000000-E	1610	STONE FOR EROSION CONTROL, CLASS A	525 TON		
0184	6009000000-E	1610	STONE FOR EROSION CONTROL, CLASS B	465 TON		
0185	6012000000-E	1610	SEDIMENT CONTROL STONE	790 TON		
0186	6015000000-E	1615	TEMPORARY MULCHING	7 ACR		
0187	6018000000-E	1620	SEED FOR TEMPORARY SEEDING	500 LB		
0188	6021000000-E	1620	FERTILIZER FOR TEMPORARY SEED- ING	3.5 TON		
0189	6024000000-E	1622	TEMPORARY SLOPE DRAINS	200 LF		



County : Alamance

Line #	Item Number	Sec #	Description	Quantity	Unit Cost	Amount
0190	6029000000-E	SP	SAFETY FENCE	600 LF		
0191	6030000000-E	1630	SILT EXCAVATION	900 CY		
0192	6036000000-E	1631	MATTING FOR EROSION CONTROL	9,680 SY		
0193	6037000000-E	SP	COIR FIBER MAT	100 SY		
0194	6042000000-E	1632	1/4" HARDWARE CLOTH	3,240 LF		
0195	6071012000-E	SP	COIR FIBER WATTLE	90 LF		
0196	6071020000-E	SP	POLYACRYLAMIDE (PAM)	60 LB		
0197	6071030000-E	1640	COIR FIBER BAFFLE	105 LF		
0198	6071050000-E	SP	*** SKIMMER (1-1/2")	1 EA		
0199	6084000000-E	1660	SEEDING & MULCHING	6 ACR		
0200	6087000000-E	1660	MOWING	6 ACR		
0201	6090000000-E	1661	SEED FOR REPAIR SEEDING	100 LB		
0202	6093000000-E	1661	FERTILIZER FOR REPAIR SEEDING	0.25 TON		
0203	6096000000-E	1662	SEED FOR SUPPLEMENTAL SEEDING	150 LB		
0204	6108000000-E	1665	FERTILIZER TOPDRESSING	4.5 TON		
0205	6114500000-N	1667	SPECIALIZED HAND MOWING	10 MHR		
0206	6117000000-N	SP	RESPONSE FOR EROSION CONTROL	25 EA		
0207	6117500000-N	SP	CONCRETE WASHOUT STRUCTURE	12 EA		
0208	6132000000-N	SP	GENERIC EROSION CONTROL ITEM FABRIC INSERT INLET PROTECTION DEVICE	45 EA		

County : Alamance

Line #	Item Number	Sec #	Description	Quantity	Unit Cost	Amount
0209	6132000000-N	SP	GENERIC EROSION CONTROL ITEM FABRIC INSERT INLET PROTECTION DEVICE CLEANOUT	100 EA		
0210	7048500000-E	1705	PEDESTRIAN SIGNAL HEAD (16", 1 SECTION W/COUNTDOWN)	35 EA		
0211	7060000000-E	1705	SIGNAL CABLE	24,800 LF		
0212	7120000000-E	1705	VEHICLE SIGNAL HEAD (12", 3 SECTION)	110 EA		
0213	7132000000-E	1705	VEHICLE SIGNAL HEAD (12", 4 SECTION)	21 EA		
0214	7144000000-E	1705	VEHICLE SIGNAL HEAD (12", 5 SECTION)	6 EA		
0215	7229000000-N	SP	APS DETECTOR STATION	8 EA		
0216	7230000000-N	SP	CENTRAL CONTROL UNIT APS DETECTOR STATION	1 EA		
0217	7252000000-E	1710	MESSENGER CABLE (1/4")	925 LF		
0218	7264000000-E	1710	MESSENGER CABLE (3/8")	5,250 LF		
0219	7279000000-E	1715	TRACER WIRE	2,500 LF		
0220	7288000000-E	1715	PAVED TRENCHING (***** (1, 2"))	300 LF		
0221	7300000000-E	1715	UNPAVED TRENCHING (***** (1, 2"))	2,350 LF		
0222	7300000000-E	1715	UNPAVED TRENCHING (***** (2, 2"))	1,335 LF		
0223	7300000000-E	1715	UNPAVED TRENCHING (***** (3, 2"))	100 LF		
0224	7301000000-E	1715	DIRECTIONAL DRILL (***** (1, 2"))	55 LF		
0225	7301000000-E	1715	DIRECTIONAL DRILL (***** (2, 2"))	1,125 LF		

County : Alamance

Line #	Item Number	Sec #	Description	Quantity	Unit Cost	Amount
0226	7324000000-N	1716	JUNCTION BOX (STANDARD SIZE)	50 EA		
0227	7348000000-N	1716	JUNCTION BOX (OVER-SIZED, HEAVY DUTY)	20 EA		
0228	7360000000-N	1720	WOOD POLE	19 EA		
0229	7372000000-N	1721	GUY ASSEMBLY	41 EA		
0230	7396000000-E	1722	1/2" RISER WITH WEATHERHEAD	2 EA		
0231	7408000000-E	1722	1" RISER WITH WEATHERHEAD	5 EA		
0232	7420000000-E	1722	2" RISER WITH WEATHERHEAD	22 EA		
0233	7430000000-N	1722	HEAT SHRINK TUBING RETROFIT KIT	5 EA		
0234	7432000000-E	1722	2" RISER WITH HEAT SHRINK TUBING	3 EA		
0235	7444000000-E	1725	INDUCTIVE LOOP SAWCUT	7,275 LF		
0236	7456000000-E	1726	LEAD-IN CABLE (***** (14-2)	32,175 LF		
0237	7481000000-N	SP	SITE SURVEY	5 EA		
0238	7481240000-N	SP	CAMERA WITHOUT INTERNAL LOOP EMULATOR PROCESSING UNIT	17 EA		
0239	7481260000-N	SP	EXTERNAL LOOP EMULATOR PROCESSING UNIT	5 EA		
0240	7481280000-N	SP	RELOCATE CAMERA SENSOR UNIT	23 EA		
0241	7516000000-E	1730	COMMUNICATIONS CABLE (**FIBER) (12)	5,425 LF		
0242	7528000000-E	1730	DROP CABLE	450 LF		
0243	7540000000-N	1731	SPLICE ENCLOSURE	5 EA		
0244	7541000000-N	1731	MODIFY SPLICE ENCLOSURE	3 EA		

County : Alamance

Line #	Item Number	Sec #	Description	Quantity	Unit Cost	Amount
0245	7552000000-N	1731	INTERCONNECT CENTER	6	EA	
0246	7566000000-N	1733	DELINEATOR MARKER	11	EA	
0247	7575142010-N	1736	900MHZ SERIAL/ETHERNET SPREAD SPECTRUM RADIO	8	EA	
0248	7575142060-N	SP	MODIFY RADIO INSTALLATION	1	EA	
0249	7575160000-E	1734	REMOVE EXISTING COMMUNICATIONS CABLE	3,175	LF	
0250	7575180000-N	1735	CABLE TRANSFER	1	EA	
0251	7576000000-N	SP	METAL STRAIN SIGNAL POLE	20	EA	
0252	7613000000-N	SP	SOIL TEST	20	EA	
0253	7614100000-E	SP	DRILLED PIER FOUNDATION	140	CY	
0254	7636000000-N	1745	SIGN FOR SIGNALS	63	EA	
0255	7642100000-N	1743	TYPE I POST WITH FOUNDATION	20	EA	
0256	7642200000-N	1743	TYPE II PEDESTAL WITH FOUNDATION	16	EA	
0257	7648000000-N	1746	RELOCATE EXISTING SIGN	1	EA	
0258	7684000000-N	1750	SIGNAL CABINET FOUNDATION	8	EA	
0259	7686000000-N	1752	CONDUIT ENTRANCE INTO EXISTING FOUNDATION	10	EA	
0260	7696000000-N	1751	CONTROLLERS WITH CABINET (*****) (TYPE 2070LX, BASE MOUNTED)	9	EA	
0261	7744000000-N	1751	DETECTOR CARD (TYPE 170)	89	EA	
0262	7901000000-N	1753	CABINET BASE EXTENDER	9	EA	
0263	7960000000-N	SP	METAL POLE FOUNDATION REMOVAL	1	EA	

County : Alamance

Line #	Item Number	Sec #	Description	Quantity	Unit Cost	Amount
0264	7972000000-N	SP	METAL POLE REMOVAL	1		
					EA	
0265	7980000000-N	SP	GENERIC SIGNAL ITEM ETHERNET EDGE SWITCH	9		
					EA	
0266	7980000000-N	SP	GENERIC SIGNAL ITEM JUNCTION BOX MARKER	6		
					EA	
0267	7980000000-N	SP	GENERIC SIGNAL ITEM REMOVE RADIO INSTALLATION	8		
					EA	
0268	7990000000-E	SP	GENERIC SIGNAL ITEM BACK PULL FIBER OPTIC CABLE	425		
					LF	

#### WALL ITEMS

0269	8801000000-E	SP	MSE RETAINING WALL NO **** (1)	1,160		
					SF	
0270	8802040000-E	453	CIP GRAVITY RETAINING WALLS	325		
					SF	

#### STRUCTURE ITEMS

0271	8105540000-E	411	3'-6" DIA DRILLED PIERS IN SOIL	65		
					LF	
0272	8105640000-E	411	3'-6" DIA DRILLED PIERS NOT IN SOIL	124		
					LF	
0273	8113000000-N	411	SID INSPECTIONS	3		
					EA	
0274	8114000000-N	411	SPT TESTING	6		
					EA	
0275	8115000000-N	411	CSL TESTING	3		
					EA	
0276	8147000000-E	420	REINFORCED CONCRETE DECK SLAB	15,562		
					SF	
0277	8161000000-E	420	GROOVING BRIDGE FLOORS	25,401.6		
					SF	

County : Alamance

Line #	Item Number	Sec #	Description	Quantity	Unit Cost	Amount
0278	8182000000-E	420	CLASS A CONCRETE (BRIDGE)	297.4 CY		
0279	8210000000-N	422	BRIDGE APPROACH SLABS, STATION ***** (27+02.26 -L-)	Lump Sum	L.S.	
0280	8217000000-E	425	REINFORCING STEEL (BRIDGE)	52,536 LB		
0281	8224000000-E	425	EPOXY COATED REINFORCING STEEL (BRIDGE)	911 LB		
0282	8238000000-E	425	SPIRAL COLUMN REINFORCING STEEL (BRIDGE)	7,630 LB		
0283	8280000000-E	440	APPROX ..... LBS STRUCTURAL STEEL	441,500 LS		
0284	8328200000-E	450	PILE DRIVING EQUIPMENT SETUP FOR *** STEEL PILES (HP 12 X 53)	16 EA		
0285	8364000000-E	450	HP12X53 STEEL PILES	360 LF		
0286	8391000000-N	450	STEEL PILE POINTS	16 EA		
0287	8482000000-E	460	THREE BAR METAL RAIL	422.5 LF		
0288	8524000000-E	SP	*** CHAIN LINK FENCE (104")	427.83 LF		
0289	8531000000-E	462	4" SLOPE PROTECTION	635 SY		
0290	8559000000-E	SP	CLASS II, SURFACE PREPARATION	4.2 SY		
0291	8657000000-N	430	ELASTOMERIC BEARINGS	Lump Sum	L.S.	
0292	8664000000-E	SP	SHOTCRETE REPAIRS	6.4 CF		
0293	8678000000-E	SP	EPOXY RESIN INJECTION	1,112 LF		
0294	8692000000-N	SP	FOAM JOINT SEALS	Lump Sum	L.S.	
0295	8727000000-N	SP	ELECTRICAL CONDUIT SYSTEM FOR SIGNALS AT STA***** (27+02.26 -L-)	Lump Sum	L.S.	

County : Alamance

Line #	Item Number	Sec #	Description	Quantity	Unit Cost	Amount
0296	8881000000-E	SP	GENERIC STRUCTURE ITEM POLYESTER POLYMER CONCRETE MATERIALS	62.1 CY		
0297	8892000000-E	SP	GENERIC STRUCTURE ITEM EPOXY COATING	647 SF		
0298	8893000000-E	SP	GENERIC STRUCTURE ITEM CONCRETE DECK REPAIR FOR POLYESTER POLYMER CONCRETE OVE RLAY	4.2 SY		
0299	8893000000-E	SP	GENERIC STRUCTURE ITEM PLACING & FINISHING POLYESTER POLYMER CONCRETE OVERLAY	2,234.5 SY		
0300	8893000000-E	SP	GENERIC STRUCTURE ITEM SCARIFYING BRIDGE DECK	1,464.5 SY		
0301	8893000000-E	SP	GENERIC STRUCTURE ITEM SHOTBLASTING BRIDGE DECK	2,234.5 SY		
0302	8035000000-N	402	REMOVAL OF EXISTING STRUCTURE AT STATION ***** (27+02.26 -L-)	Lump Sum	L.S.	

0824/Mar04/Q929048.609/D1534325746070/E302

Total Amount Of Bid For Entire Project :

## Vendor 1 of 3: ZACHRY CONSTRUCTION CORPORATION (9105) Call Order 008 (Proposal: C204603)

### Bid Information

---

<b>Proposal County:</b> ALAMANCE	<b>Bid Checksum:</b> C85EB9C8DE
<b>Vendor Address:</b> P.O. BOX 33240 SAN ANTONIO , TX , 78265	<b>Bid Total:</b> \$12,865,732.71
<b>Signature Check:</b> Samuel Edward White	<b>Items Total:</b> \$12,865,732.71
<b>Time Bid Received:</b> March 16, 2021 01:51 PM	<b>Time Total:</b> \$0.00
<b>Amendment Count:</b> 1	

**Bidding Errors:**  
None.



Vendor 1 of 3: ZACHRY CONSTRUCTION CORPORATION (9105)  
Call Order 008 (Proposal: C204603)

Bid Bond Information

---

<b>Projects:</b>	<b>Bond Maximum:</b>
<b>Counties:</b>	<b>State of Incorporation:</b>
<b>Bond ID:</b> SNC21214035	<b>Agency Execution Date:</b> 03/10/2021 09
<b>Paid by Check:</b> No	<b>Surety Name:</b> Surety2000
<b>Bond Percent:</b> 5%	<b>Bond Agency Name:</b> Fidelity and Deposit Company of Maryland/Zurich

**DBE Load Information**

Letting ID: L210316  
Letting Date: 03/16/2021  
Call Order: 008  
Contract ID: C204603  
Project: NHPP-040-4 (161) 220NHPP-040-4 (161) 220NHPP-040-4 (161) 220NHPP-040-4 (161)  
220  
Bid Total: \$12,865,732.71  
DBE Goal: 5.00% (\$643,286.64)

Vendor ID: 9105  
Vendor Name: Zachry Construction Corp  
DBE Entered: 5.13% (\$659,639.55)

<b>Vendor ID</b>	<b>DBE Name</b>	<b>Is Supplier?</b>	<b>City/State</b>	<b>Goods/Service</b>	<b>Amount</b>
11572	CRUZ BROTHERS CONCRETE, INC.	False	1572 PAYNE ROAD/LOT 75 LOT 75 , GRAHAM, NC 27253	SubContractor  committed	467,620.50
1991	MCCAIN STRIPING SERVICE INC	False	5711 CRAVEN ROAD , BROWNS SUMMIT, NC 27214	SubContractor  committed	192,019.05

Letting: L210316  
03/16/2021 02:00:00 PM

North Carolina Department of Transportation  
9105 - Zachry Construction Corp

Contract ID: C204603  
Call: 008

BondID: SNC21214035

Surety Registry Agency: Surety2000

Verified?: 1

Surety Agency: Fidelity and Deposit Company of Maryland/Zurich

Bond Execution Date: 03/10/2021 09:25:59 AM

Line Number	Item Number	Quantity	Unit	Unit Price	Extension Price
Section 0001 ROADWAY ITEMS					
0001	0000100000-N MOBILIZATION	1.000	LS	\$643,000.0100	\$643,000.01
0002	0000400000-N CONSTRUCTION SURVEYING	1.000	LS	\$175,000.0000	\$175,000.00
0003	0030000000-N TYPE II MODIFIED APPROACH FILL, STATION ***** (27+02.26 -L-)	1.000	LS	\$40,000.0000	\$40,000.00
0004	0036000000-E UNDERCUT EXCAVATION	2475.000	CY	\$9.0000	\$22,275.00
0005	0043000000-N GRADING	1.000	LS	\$857,353.7700	\$857,353.77
0006	0050000000-E SUPPLEMENTARY CLEARING & GRUB-BING	1.000	ACR	\$8,000.0000	\$8,000.00
0007	0134000000-E DRAINAGE DITCH EXCAVATION	25.000	CY	\$20.0000	\$500.00
0008	0195000000-E SELECT GRANULAR MATERIAL	1975.000	CY	\$22.0000	\$43,450.00
0009	0196000000-E GEOTEXTILE FOR SOIL STABILIZA-TION	3075.000	SY	\$1.2500	\$3,843.75
0010	0199000000-E TEMPORARY SHORING	140.000	SF	\$80.0000	\$11,200.00
0011	0255000000-E GENERIC GRADING ITEM HAULING & DISPOSAL OF PETRO- LEUM CONTAMINATED SOIL	60.000	TON	\$150.0000	\$9,000.00
0012	0318000000-E FOUNDATION CONDITIONING MATE- RIAL, MINOR STRUCTURES	460.000	TON	\$20.0000	\$9,200.00
0013	0320000000-E FOUNDATION CONDITIONING GEO- TEXTILE	1420.000	SY	\$2.5000	\$3,550.00
0014	0343000000-E 15" SIDE DRAIN PIPE	1024.000	LF	\$50.0000	\$51,200.00
0015	0344000000-E 18" SIDE DRAIN PIPE	124.000	LF	\$55.0000	\$6,820.00
0016	0345000000-E 24" SIDE DRAIN PIPE	280.000	LF	\$60.0000	\$16,800.00
0017	0348000000-E **" SIDE DRAIN PIPE ELBOWS (15")	6.000	EA	\$300.0000	\$1,800.00
0018	0378000000-E 24" RC PIPE CULVERTS, CLASS III	44.000	LF	\$85.0000	\$3,740.00
0019	0448200000-E 15" RC PIPE CULVERTS, CLASS IV	1956.000	LF	\$70.0000	\$136,920.00
0020	0448300000-E 18" RC PIPE CULVERTS, CLASS IV	240.000	LF	\$80.0000	\$19,200.00
0021	0448400000-E 24" RC PIPE CULVERTS, CLASS IV	584.000	LF	\$100.0000	\$58,400.00
0022	0995000000-E PIPE REMOVAL	2034.000	LF	\$13.0000	\$26,442.00
0023	1099500000-E SHALLOW UNDERCUT	350.000	CY	\$22.0000	\$7,700.00

0024	1099700000-E	650.000 TON	\$22.0000	\$14,300.00
	CLASS IV SUBGRADE STABILIZATION			
0025	1220000000-E	1000.000 TON	\$25.0000	\$25,000.00
	INCIDENTAL STONE BASE			
0026	1297000000-E	21400.000 SY	\$2.0000	\$42,800.00
	MILLING ASPHALT PAVEMENT, ***"DEPTH (1-1/2")			
0027	1297000000-E	19150.000 SY	\$3.0000	\$57,450.00
	MILLING ASPHALT PAVEMENT, ***"DEPTH (3")			
0028	1330000000-E	2110.000 SY	\$8.5000	\$17,935.00
	INCIDENTAL MILLING			
0029	1491000000-E	7500.000 TON	\$75.0000	\$562,500.00
	ASPHALT CONC BASE COURSE, TYPE B25.0C			
0030	1503000000-E	5100.000 TON	\$75.0000	\$382,500.00
	ASPHALT CONC INTERMEDIATE COURSE, TYPE I19.0C			
0031	1519000000-E	5900.000 TON	\$70.0000	\$413,000.00
	ASPHALT CONC SURFACE COURSE, TYPE S9.5B			
0032	1523000000-E	1200.000 TON	\$95.0000	\$114,000.00
	ASPHALT CONC SURFACE COURSE, TYPE S9.5C			
0033	1524200000-E	2100.000 TON	\$85.0000	\$178,500.00
	ASPHALT CONC SURFACE COURSE, TYPE S9.5D			
0034	1575000000-E	1195.000 TON	\$390.0000	\$466,050.00
	ASPHALT BINDER FOR PLANT MIX			
0035	1577000000-E	120.000 TON	\$545.0000	\$65,400.00
	POLYMER MODIFIED ASPHALT BINDER FOR PLANT MIX			
0036	1693000000-E	1000.000 TON	\$80.0000	\$80,000.00
	ASPHALT PLANT MIX, PAVEMENT REPAIR			
0037	1840000000-E	6900.000 LF	\$0.7600	\$5,244.00
	MILLED RUMBLE STRIPS (ASPHALT CONCRETE)			
0038	2022000000-E	22.400 CY	\$20.0000	\$448.00
	SUBDRAIN EXCAVATION			
0039	2026000000-E	100.000 SY	\$5.0000	\$500.00
	GEOTEXTILE FOR SUBSURFACE DRAINS			
0040	2036000000-E	16.800 CY	\$65.0000	\$1,092.00
	SUBDRAIN COARSE AGGREGATE			
0041	2044000000-E	100.000 LF	\$15.0000	\$1,500.00
	6" PERFORATED SUBDRAIN PIPE			
0042	2070000000-N	1.000 EA	\$350.0000	\$350.00
	SUBDRAIN PIPE OUTLET			
0043	2077000000-E	6.000 LF	\$35.0000	\$210.00
	6" OUTLET PIPE			
0044	2264000000-E	0.029 CY	\$5,500.0000	\$159.50
	PIPE PLUGS			
0045	2286000000-N	64.000 EA	\$3,000.0000	\$192,000.00
	MASONRY DRAINAGE STRUCTURES			
0046	2308000000-E	2.400 LF	\$450.0000	\$1,080.00
	MASONRY DRAINAGE STRUCTURES			
0047	2363000000-N	6.000 EA	\$700.0000	\$4,200.00
	FRAME WITH TWO GRATES, STD 840.***** (840.15)			
0048	2364000000-N	6.000 EA	\$700.0000	\$4,200.00

		FRAME WITH TWO GRATES, STD	840.16			
0049	2365000000-N	1.000 EA		\$625.0000		\$625.00
		FRAME WITH TWO GRATES, STD	840.22			
0050	2374000000-N	8.000 EA		\$800.0000		\$6,400.00
		FRAME WITH GRATE & HOOD, STD	840.03, TYPE ** (E)			
0051	2374000000-N	25.000 EA		\$800.0000		\$20,000.00
		FRAME WITH GRATE & HOOD, STD	840.03, TYPE ** (F)			
0052	2374000000-N	24.000 EA		\$800.0000		\$19,200.00
		FRAME WITH GRATE & HOOD, STD	840.03, TYPE ** (G)			
0053	2451000000-N	3.000 EA		\$850.0000		\$2,550.00
		CONCRETE TRANSITIONAL SECTION FOR DROP INLET				
0054	2535000000-E	30.000 LF		\$26.0000		\$780.00
		**"X **" CONCRETE CURB (8" X 12")				
0055	2549000000-E	8970.000 LF		\$21.6500		\$194,200.50
		2'-6" CONCRETE CURB & GUTTER				
0056	2591000000-E	2260.000 SY		\$41.2500		\$93,225.00
		4" CONCRETE SIDEWALK				
0057	2605000000-N	54.000 EA		\$2,100.0000		\$113,400.00
		CONCRETE CURB RAMPS				
0058	2612000000-E	40.000 SY		\$82.0000		\$3,280.00
		6" CONCRETE DRIVEWAY				
0059	2627000000-E	140.000 SY		\$41.2500		\$5,775.00
		4" CONCRETE ISLAND COVER				
0060	2647000000-E	140.000 SY		\$71.5000		\$10,010.00
		5" MONOLITHIC CONCRETE ISLANDS (SURFACE MOUNTED)				
0061	2655000000-E	600.000 SY		\$71.5000		\$42,900.00
		5" MONOLITHIC CONCRETE ISLANDS (KEYED IN)				
0062	2710000000-N	2.000 EA		\$2,500.0000		\$5,000.00
		CONCRETE BARRIER TRANSITION SECTION				
0063	2724000000-E	140.000 LF		\$200.0000		\$28,000.00
		PRECAST REINFORCED CONCRETE BARRIER, SINGLE FACED				
0064	2800000000-N	1.000 EA		\$4,500.0000		\$4,500.00
		ADJUSTMENT OF CATCH BASINS				
0065	3030000000-E	700.000 LF		\$18.5200		\$12,964.00
		STEEL BEAM GUARDRAIL				
0066	3045000000-E	175.000 LF		\$19.5400		\$3,419.50
		STEEL BEAM GUARDRAIL, SHOP CURVED				
0067	3145000000-E	41.000 EA		\$65.9700		\$2,704.77
		EXTRA LENGTH GUARDRAIL POST (**' STEEL) (8')				
0068	3150000000-N	5.000 EA		\$1.0200		\$5.10
		ADDITIONAL GUARDRAIL POSTS				
0069	3195000000-N	3.000 EA		\$507.5000		\$1,522.50
		GUARDRAIL END UNITS, TYPE AT-1				
0070	3215000000-N	2.000 EA		\$1,725.5000		\$3,451.00
		GUARDRAIL ANCHOR UNITS, TYPE III				
0071	3287000000-N	3.000 EA		\$2,537.5000		\$7,612.50
		GUARDRAIL END UNITS, TYPE TL-3				
0072	3317000000-N	2.000 EA		\$1,700.1300		\$3,400.26
		GUARDRAIL ANCHOR UNITS, TYPE B-77				

0073	3360000000-E	605.000 LF	\$0.9100	\$550.55
	REMOVE EXISTING GUARDRAIL			
0074	3503000000-E	700.000 LF	\$6.0000	\$4,200.00
	WOVEN WIRE FENCE, 47" FABRIC			
0075	3509000000-E	35.000 EA	\$22.0000	\$770.00
	4" TIMBER FENCE POSTS, 7'-6" LONG			
0076	3515000000-E	28.000 EA	\$38.0000	\$1,064.00
	5" TIMBER FENCE POSTS, 8'-0" LONG			
0077	3575000000-E	50.000 LF	\$225.0000	\$11,250.00
	GENERIC FENCING ITEM STEEL PIPE HANDRAIL			
0078	3649000000-E	30.000 TON	\$45.0000	\$1,350.00
	RIP RAP, CLASS B			
0079	3656000000-E	1425.000 SY	\$3.5000	\$4,987.50
	GEOTEXTILE FOR DRAINAGE			
0080	4048000000-E	2.000 CY	\$250.0000	\$500.00
	REINFORCED CONCRETE SIGN FOUNDATIONS			
0081	4054000000-E	1.000 CY	\$250.0000	\$250.00
	PLAIN CONCRETE SIGN FOUNDATIONS			
0082	4057000000-E	36.000 CY	\$1,525.0000	\$54,900.00
	OVERHEAD FOOTING			
0083	4060000000-E	1886.000 LB	\$4.1200	\$7,770.32
	SUPPORTS, BREAKAWAY STEEL BEAM			
0084	4066000000-E	317.000 LB	\$4.1200	\$1,306.04
	SUPPORTS, SIMPLE STEEL BEAM			
0085	4072000000-E	900.000 LF	\$6.1800	\$5,562.00
	SUPPORTS, 3-LB STEEL U-CHANNEL			
0086	4082100000-N	1.000 LS	\$139,050.0000	\$139,050.00
	SUPPORTS, OVERHEAD SIGN STRUCTURE AT STA ***** (23+15 -L-)			
0087	4082100000-N	1.000 LS	\$103,000.0000	\$103,000.00
	SUPPORTS, OVERHEAD SIGN STRUCTURE AT STA ***** (30+75 -L-)			
0088	4096000000-N	4.000 EA	\$103.0000	\$412.00
	SIGN ERECTION, TYPE D			
0089	4102000000-N	51.000 EA	\$72.1000	\$3,677.10
	SIGN ERECTION, TYPE E			
0090	4108000000-N	2.000 EA	\$103.0000	\$206.00
	SIGN ERECTION, TYPE F			
0091	4109000000-N	4.000 EA	\$1.0300	\$4.12
	SIGN ERECTION, TYPE *** (OVER-HEAD) (A)			
0092	4110000000-N	6.000 EA	\$515.0000	\$3,090.00
	SIGN ERECTION, TYPE *** (GROUND MOUNTED) (A)			
0093	4110000000-N	1.000 EA	\$360.5000	\$360.50
	SIGN ERECTION, TYPE *** (GROUND MOUNTED) (B)			
0094	4116100000-N	1.000 EA	\$515.0000	\$515.00
	SIGN ERECTION, RELOCATE TYPE **** (GROUND MOUNTED) (GM RESTAURANT LOGO SIGNS)			
0095	4149000000-N	1.000 EA	\$3,605.0000	\$3,605.00
	DISPOSAL OF SIGN SYSTEM, OVER-HEAD			
0096	4152000000-N	2.000 EA	\$257.5000	\$515.00
	DISPOSAL OF SIGN SYSTEM, STEELBEAM			
0097	4155000000-N	56.000 EA	\$4.1200	\$230.72

DISPOSAL OF SIGN SYSTEM, U- CHANNEL					
0098	4158000000-N	2.000	EA	\$4.1200	\$8.24
DISPOSAL OF SIGN SYSTEM, WOOD					
0099	4192000000-N	1.000	EA	\$4.1200	\$4.12
DISPOSAL OF SUPPORT, U-CHANNEL					
0100	4400000000-E	524.000	SF	\$4.3400	\$2,274.16
WORK ZONE SIGNS (STATIONARY)					
0101	4405000000-E	624.000	SF	\$8.1600	\$5,091.84
WORK ZONE SIGNS (PORTABLE)					
0102	4410000000-E	142.000	SF	\$5.1000	\$724.20
WORK ZONE SIGNS (BARRICADE MOUNTED)					
0103	4415000000-N	6.000	EA	\$4,250.0000	\$25,500.00
FLASHING ARROW BOARD					
0104	4420000000-N	6.000	EA	\$14,550.0000	\$87,300.00
PORTABLE CHANGEABLE MESSAGE SIGN					
0105	4422000000-N	40.000	DAY	\$35.7000	\$1,428.00
PORTABLE CHANGEABLE MESSAGE SIGN (SHORT TERM)					
0106	4430000000-N	580.000	EA	\$50.0000	\$29,000.00
DRUMS					
0107	4434000000-N	40.000	EA	\$100.0000	\$4,000.00
SEQUENTIAL FLASHING WARNING LIGHTS					
0108	4435000000-N	60.000	EA	\$15.0000	\$900.00
CONES					
0109	4445000000-E	96.000	LF	\$25.0000	\$2,400.00
BARRICADES (TYPE III)					
0110	4447000000-E	72.000	LF	\$25.0000	\$1,800.00
PEDESTRIAN CHANNELIZING DEVICES					
0111	4455000000-N	480.000	DAY	\$300.0000	\$144,000.00
FLAGGER					
0112	4465000000-N	7.000	EA	\$5,000.0000	\$35,000.00
TEMPORARY CRASH CUSHIONS					
0113	4470000000-N	3.000	EA	\$3,000.0000	\$9,000.00
REMOVE & RESET TEMPORARY CRASH CUSHION					
0114	4480000000-N	4.000	EA	\$40,000.0000	\$160,000.00
TMA					
0115	4485000000-E	3205.000	LF	\$40.0000	\$128,200.00
PORTABLE CONCRETE BARRIER					
0116	4490000000-E	1150.000	LF	\$66.0000	\$75,900.00
PORTABLE CONCRETE BARRIER (ANCHORED)					
0117	4505000000-E	410.000	LF	\$9.0000	\$3,690.00
REMOVE & RESET PORTABLE CONC-					
0118	4600000000-N	6.000	EA	\$200.0000	\$1,200.00
GENERIC TRAFFIC CONTROL ITEM AUDIBLE WARNING DEVICES					
0119	4600000000-N	1500.000	EA	\$0.0100	\$15.00
GENERIC TRAFFIC CONTROL ITEM PEDESTRIAN TRANSPORT SERVICE (PER TRIP)					
0120	4650000000-N	570.000	EA	\$4.7800	\$2,724.60
TEMPORARY RAISED PAVEMENT MARKERS					
0121	4685000000-E	13979.000	LF	\$0.8700	\$12,161.73
THERMOPLASTIC PAVEMENT MARKING LINES (4", 90 MILS)					



0122	4688000000-E	10248.000 LF	\$0.9900	\$10,145.52
	THERMOPLASTIC PAVEMENT MARKING LINES (6", 90 MILS)			
0123	4695000000-E	3397.000 LF	\$1.9500	\$6,624.15
	THERMOPLASTIC PAVEMENT MARKING LINES (8", 90 MILS)			
0124	4700000000-E	995.000 LF	\$3.5000	\$3,482.50
	THERMOPLASTIC PAVEMENT MARKING LINES (12", 90 MILS)			
0125	4720000000-E	12.000 EA	\$90.0000	\$1,080.00
	THERMOPLASTIC PAVEMENT MARKING CHARACTER (90 MILS)			
0126	4725000000-E	99.000 EA	\$90.0000	\$8,910.00
	THERMOPLASTIC PAVEMENT MARKING SYMBOL (90 MILS)			
0127	4726110000-E	24.000 EA	\$150.0000	\$3,600.00
	HEATED-IN-PLACE THERMOPLASTIC PAVEMENT MARKING SYMBOL			
0128	4770000000-E	1617.000 LF	\$3.0000	\$4,851.00
	COLD APPLIED PLASTIC PAVEMENT MARKING LINES, TYPE ** (4") (II)			
0129	4770000000-E	310.000 LF	\$3.5000	\$1,085.00
	COLD APPLIED PLASTIC PAVEMENT MARKING LINES, TYPE ** (4") (IV)			
0130	4805000000-N	10.000 EA	\$200.0000	\$2,000.00
	COLD APPLIED PLASTIC PAVEMENT MARKING SYMBOL, TYPE ** (II)			
0131	4805000000-N	2.000 EA	\$390.0000	\$780.00
	COLD APPLIED PLASTIC PAVEMENT MARKING SYMBOL, TYPE ** (IV)			
0132	4810000000-E	33600.000 LF	\$0.3500	\$11,760.00
	PAINT PAVEMENT MARKING LINES (4")			
0133	4815000000-E	33000.000 LF	\$0.4700	\$15,510.00
	PAINT PAVEMENT MARKING LINES (6")			
0134	4820000000-E	1820.000 LF	\$1.0000	\$1,820.00
	PAINT PAVEMENT MARKING LINES (8")			
0135	4825000000-E	400.000 LF	\$2.0000	\$800.00
	PAINT PAVEMENT MARKING LINES (12")			
0136	4835000000-E	730.000 LF	\$2.5000	\$1,825.00
	PAINT PAVEMENT MARKING LINES (24")			
0137	4840000000-N	36.000 EA	\$35.0000	\$1,260.00
	PAINT PAVEMENT MARKING CHARACTER			
0138	4845000000-N	109.000 EA	\$35.0000	\$3,815.00
	PAINT PAVEMENT MARKING SYMBOL			
0139	4850000000-E	5200.000 LF	\$0.7500	\$3,900.00
	REMOVAL OF PAVEMENT MARKING LINES (4")			
0140	4855000000-E	22000.000 LF	\$1.1000	\$24,200.00
	REMOVAL OF PAVEMENT MARKING LINES (6")			
0141	4860000000-E	800.000 LF	\$1.5000	\$1,200.00
	REMOVAL OF PAVEMENT MARKING LINES (8")			
0142	4870000000-E	120.000 LF	\$3.7500	\$450.00
	REMOVAL OF PAVEMENT MARKING LINES (24")			
0143	4875000000-N	18.000 EA	\$50.0000	\$900.00
	REMOVAL OF PAVEMENT MARKING SYMBOLS & CHARACTERS			
0144	4891000000-E	4183.000 LF	\$6.7500	\$28,235.25
	GENERIC PAVEMENT MARKING ITEM THERMOPLASTIC PAVEMENT MARKING LINES (24", 90 MILS)			
0145	4900000000-N	35.000 EA	\$4.7800	\$167.30
	PERMANENT RAISED PAVEMENT MARKERS			

0146	4905000000-N	351.000	EA	\$32.0000	\$11,232.00
	SNOWPLOWABLE PAVEMENT MARKERS				
0147	5070000000-N	3.000	EA	\$732.2500	\$2,196.75
	STANDARD FOUNDATION ***** (TYPE R1)				
0148	5155000000-E	155.000	LF	\$13.1300	\$2,035.15
	ELECTRICAL DUCT, TYPE BD, SIZE ***** (2")				
0149	5160000000-E	45.000	LF	\$17.1700	\$772.65
	ELECTRICAL DUCT, TYPE JA, SIZE ***** (3")				
0150	5160000000-E	135.000	LF	\$25.2500	\$3,408.75
	ELECTRICAL DUCT, TYPE JA, SIZE ***** (4")				
0151	5185000000-E	310.000	LF	\$7.3200	\$2,269.20
	** #2 W/G FEEDER CIRCUIT (2)				
0152	5215000000-E	650.000	LF	\$10.3500	\$6,727.50
	** #4 W/G FEEDER CIRCUIT IN ***** CONDUIT (2, 1.5")				
0153	5220000000-E	330.000	LF	\$11.8700	\$3,917.10
	** #2 W/G FEEDER CIRCUIT IN ***** CONDUIT (2, 1.5")				
0154	5240000000-N	3.000	EA	\$329.2600	\$987.78
	ELECTRICAL JUNCTION BOXES ***** (IG18)				
0155	5240000000-N	3.000	EA	\$329.2600	\$987.78
	ELECTRICAL JUNCTION BOXES ***** (LS18)				
0156	5255000000-N	1.000	LS	\$50,000.0000	\$50,000.00
	PORTABLE LIGHTING				
0157	5260000000-N	1.000	LS	\$2,525.0000	\$2,525.00
	GENERIC LIGHTING ITEM LUMINAIRE STORAGE				
0158	5270000000-N	1.000	EA	\$1,818.0000	\$1,818.00
	GENERIC LIGHTING ITEM RELOCATE LIGHT STANDARD				
0159	5270000000-N	1.000	EA	\$909.0000	\$909.00
	GENERIC LIGHTING ITEM REMOVE LIGHT STANDARD FOUNDATION				
0160	5270000000-N	1.000	EA	\$606.0000	\$606.00
	GENERIC LIGHTING ITEM REMOVE SINGLE ARM LIGHT STANDARD				
0161	5325800000-E	10.000	LF	\$150.0000	\$1,500.00
	8" WATER LINE				
0162	5326200000-E	325.000	LF	\$165.0000	\$53,625.00
	12" WATER LINE				
0163	5329000000-E	3115.000	LB	\$6.0000	\$18,690.00
	DUCTILE IRON WATER PIPE FITTINGS				
0164	5540000000-E	1.000	EA	\$2,500.0000	\$2,500.00
	6" VALVE				
0165	5546000000-E	1.000	EA	\$3,500.0000	\$3,500.00
	8" VALVE				
0166	5558000000-E	4.000	EA	\$5,000.0000	\$20,000.00
	12" VALVE				
0167	5571000000-E	1.000	EA	\$7,500.0000	\$7,500.00
	*** TAPPING SLEEVE & VALVE (2")				
0168	5648000000-N	8.000	EA	\$2,500.0000	\$20,000.00
	RELOCATE WATER METER				
0169	5649000000-N	2.000	EA	\$2,000.0000	\$4,000.00
	RECONNECT WATER METER				
0170	5653100000-E	3.000	EA	\$3,250.0000	\$9,750.00

RELOCATE *** DCV BACKFLOW PRE-VENTION ASSEMBLY (1")					
0171	5653100000-E	3.000	EA	\$3,500.0000	\$10,500.00
RELOCATE *** DCV BACKFLOW PRE-VENTION ASSEMBLY (2")					
0172	5672000000-N	3.000	EA	\$3,500.0000	\$10,500.00
RELOCATE FIRE HYDRANT					
0173	5673000000-E	80.000	LF	\$200.0000	\$16,000.00
FIRE HYDRANT LEG					
0174	5686000000-E	70.000	LF	\$60.0000	\$4,200.00
*** WATER SERVICE LINE (1")					
0175	5686000000-E	95.000	LF	\$65.0000	\$6,175.00
*** WATER SERVICE LINE (2")					
0176	5691200000-E	10.000	LF	\$300.0000	\$3,000.00
6" SANITARY GRAVITY SEWER					
0177	5691300000-E	165.000	LF	\$350.0000	\$57,750.00
8" SANITARY GRAVITY SEWER					
0178	5775000000-E	3.000	EA	\$8,000.0000	\$24,000.00
4' DIA UTILITY MANHOLE					
0179	5801000000-E	134.000	LF	\$40.0000	\$5,360.00
ABANDON 8" UTILITY PIPE					
0180	5828000000-N	2.000	EA	\$4,500.0000	\$9,000.00
REMOVE UTILITY MANHOLE					
0181	5882000000-N	2.000	EA	\$25,000.0000	\$50,000.00
GENERIC UTILITY ITEM 12" INSERT VALVE					
0182	6000000000-E	7880.000	LF	\$3.0000	\$23,640.00
TEMPORARY SILT FENCE					
0183	6006000000-E	525.000	TON	\$45.0000	\$23,625.00
STONE FOR EROSION CONTROL, CLASS A					
0184	6009000000-E	465.000	TON	\$45.0000	\$20,925.00
STONE FOR EROSION CONTROL, CLASS B					
0185	6012000000-E	790.000	TON	\$26.0000	\$20,540.00
SEDIMENT CONTROL STONE					
0186	6015000000-E	7.000	ACR	\$1,217.1900	\$8,520.33
TEMPORARY MULCHING					
0187	6018000000-E	500.000	LB	\$2.4400	\$1,220.00
SEED FOR TEMPORARY SEEDING					
0188	6021000000-E	3.500	TON	\$949.4100	\$3,322.94
FERTILIZER FOR TEMPORARY SEED-ING					
0189	6024000000-E	200.000	LF	\$17.4200	\$3,484.00
TEMPORARY SLOPE DRAINS					
0190	6029000000-E	600.000	LF	\$1.4700	\$882.00
SAFETY FENCE					
0191	6030000000-E	900.000	CY	\$7.6900	\$6,921.00
SILT EXCAVATION					
0192	6036000000-E	9680.000	SY	\$1.4700	\$14,229.60
MATTING FOR EROSION CONTROL					
0193	6037000000-E	100.000	SY	\$6.5700	\$657.00
COIR FIBER MAT					
0194	6042000000-E	3240.000	LF	\$2.4400	\$7,905.60
1/4" HARDWARE CLOTH					

0195	6071012000-E COIR FIBER WATTLE	90.000	LF	\$9.4900	\$854.10
0196	6071020000-E POLYACRYLAMIDE (PAM)	60.000	LB	\$14.6100	\$876.60
0197	6071030000-E COIR FIBER BAFFLE	105.000	LF	\$6.5700	\$689.85
0198	6071050000-E **" SKIMMER (1-1/2")	1.000	EA	\$1,589.9200	\$1,589.92
0199	6084000000-E SEEDING & MULCHING	6.000	ACR	\$1,777.0900	\$10,662.54
0200	6087000000-E MOWING	6.000	ACR	\$121.7200	\$730.32
0201	6090000000-E SEED FOR REPAIR SEEDING	100.000	LB	\$6.5700	\$657.00
0202	6093000000-E FERTILIZER FOR REPAIR SEEDING	0.250	TON	\$1,066.2600	\$266.57
0203	6096000000-E SEED FOR SUPPLEMENTAL SEEDING	150.000	LB	\$6.5700	\$985.50
0204	6108000000-E FERTILIZER TOPDRESSING	4.500	TON	\$1,071.1300	\$4,820.09
0205	6114500000-N SPECIALIZED HAND MOWING	10.000	MHR	\$82.7700	\$827.70
0206	6117000000-N RESPONSE FOR EROSION CONTROL	25.000	EA	\$438.1900	\$10,954.75
0207	6117500000-N CONCRETE WASHOUT STRUCTURE	12.000	EA	\$750.0000	\$9,000.00
0208	6132000000-N GENERIC EROSION CONTROL ITEM FABRIC INSERT INLET PROTECTION DEVICE	45.000	EA	\$131.4600	\$5,915.70
0209	6132000000-N GENERIC EROSION CONTROL ITEM FABRIC INSERT INLET PROTECTION DEVICE CLEANOUT	100.000	EA	\$170.4600	\$17,046.00
0210	7048500000-E PEDESTRIAN SIGNAL HEAD (16", 1SECTION W/COUNTDOWN)	35.000	EA	\$959.5000	\$33,582.50
0211	7060000000-E SIGNAL CABLE	24800.000	LF	\$2.0200	\$50,096.00
0212	7120000000-E VEHICLE SIGNAL HEAD (12", 3 SECTION)	110.000	EA	\$701.9500	\$77,214.50
0213	7132000000-E VEHICLE SIGNAL HEAD (12", 4 SECTION)	21.000	EA	\$858.5000	\$18,028.50
0214	7144000000-E VEHICLE SIGNAL HEAD (12", 5 SECTION)	6.000	EA	\$1,313.0000	\$7,878.00
0215	7229000000-N APS DETECTOR STATION	8.000	EA	\$808.0000	\$6,464.00
0216	7230000000-N CENTRAL CONTROL UNIT APS DETECTOR STATION	1.000	EA	\$1,818.0000	\$1,818.00
0217	7252000000-E MESSENGER CABLE (1/4")	925.000	LF	\$2.8300	\$2,617.75
0218	7264000000-E MESSENGER CABLE (3/8")	5250.000	LF	\$3.0300	\$15,907.50
0219	7279000000-E	2500.000	LF	\$0.7600	\$1,900.00

TRACER WIRE

0220	7288000000-E	300.000 LF	\$28.2800	\$8,484.00
	PAVED TRENCHING (***** (1, 2"))			
0221	7300000000-E	2350.000 LF	\$5.6600	\$13,301.00
	UNPAVED TRENCHING (***** (1, 2"))			
0222	7300000000-E	1335.000 LF	\$6.7200	\$8,971.20
	UNPAVED TRENCHING (***** (2, 2"))			
0223	7300000000-E	100.000 LF	\$18.1800	\$1,818.00
	UNPAVED TRENCHING (***** (3, 2"))			
0224	7301000000-E	55.000 LF	\$15.1500	\$833.25
	DIRECTIONAL DRILL (***** (1, 2"))			
0225	7301000000-E	1125.000 LF	\$15.9600	\$17,955.00
	DIRECTIONAL DRILL (***** (2, 2"))			
0226	7324000000-N	50.000 EA	\$297.9500	\$14,897.50
	JUNCTION BOX (STANDARD SIZE)			
0227	7348000000-N	20.000 EA	\$515.1000	\$10,302.00
	JUNCTION BOX (OVER-SIZED, HEA-VY DUTY)			
0228	7360000000-N	19.000 EA	\$1,010.0000	\$19,190.00
	WOOD POLE			
0229	7372000000-N	41.000 EA	\$707.0000	\$28,987.00
	GUY ASSEMBLY			
0230	7396000000-E	2.000 EA	\$323.2000	\$646.40
	1/2" RISER WITH WEATHERHEAD			
0231	7408000000-E	5.000 EA	\$353.5000	\$1,767.50
	1" RISER WITH WEATHERHEAD			
0232	7420000000-E	22.000 EA	\$621.1500	\$13,665.30
	2" RISER WITH WEATHERHEAD			
0233	7430000000-N	5.000 EA	\$101.0000	\$505.00
	HEAT SHRINK TUBING RETROFIT KIT			
0234	7432000000-E	3.000 EA	\$707.0000	\$2,121.00
	2" RISER WITH HEAT SHRINK TUBING			
0235	7444000000-E	7275.000 LF	\$6.8200	\$49,615.50
	INDUCTIVE LOOP SAWCUT			
0236	7456000000-E	32175.000 LF	\$1.0100	\$32,496.75
	LEAD-IN CABLE (***** (14-2)			
0237	7481000000-N	5.000 EA	\$1,196.8500	\$5,984.25
	SITE SURVEY			
0238	7481240000-N	17.000 EA	\$3,030.0000	\$51,510.00
	CAMERA WITHOUT INTERNAL LOOP EMULATOR PROCESSING UNIT			
0239	7481260000-N	5.000 EA	\$6,060.0000	\$30,300.00
	EXTERNAL LOOP EMULATOR PRO-CESSING UNIT			
0240	7481280000-N	23.000 EA	\$272.7000	\$6,272.10
	RELOCATE CAMERA SENSOR UNIT			
0241	7516000000-E	5425.000 LF	\$2.4200	\$13,128.50
	COMMUNICATIONS CABLE (**FIBER) (12)			
0242	7528000000-E	450.000 LF	\$2.8800	\$1,296.00
	DROP CABLE			
0243	7540000000-N	5.000 EA	\$2,121.0000	\$10,605.00
	SPLICE ENCLOSURE			

0244	7541000000-N	3.000	EA	\$858.5000	\$2,575.50
	MODIFY SPLICE ENCLOSURE				
0245	7552000000-N	6.000	EA	\$1,504.9000	\$9,029.40
	INTERCONNECT CENTER				
0246	7566000000-N	11.000	EA	\$65.0000	\$715.00
	DELINEATOR MARKER				
0247	7575142010-N	8.000	EA	\$4,368.2500	\$34,946.00
	900MHZ SERIAL/ETHERNET SPREAD SPECTRUM RADIO				
0248	7575142060-N	1.000	EA	\$650.4400	\$650.44
	MODIFY RADIO INSTALLATION				
0249	7575160000-E	3175.000	LF	\$1.0100	\$3,206.75
	REMOVE EXISTING COMMUNICATIONSCABLE				
0250	7575180000-N	1.000	EA	\$404.0000	\$404.00
	CABLE TRANSFER				
0251	7576000000-N	20.000	EA	\$8,080.0000	\$161,600.00
	METAL STRAIN SIGNAL POLE				
0252	7613000000-N	20.000	EA	\$717.1000	\$14,342.00
	SOIL TEST				
0253	7614100000-E	140.000	CY	\$929.2000	\$130,088.00
	DRILLED PIER FOUNDATION				
0254	7636000000-N	63.000	EA	\$382.7900	\$24,115.77
	SIGN FOR SIGNALS				
0255	7642100000-N	20.000	EA	\$1,313.0000	\$26,260.00
	TYPE I POST WITH FOUNDATION				
0256	7642200000-N	16.000	EA	\$2,020.0000	\$32,320.00
	TYPE II PEDESTAL WITH FOUNDATION				
0257	7648000000-N	1.000	EA	\$303.0000	\$303.00
	RELOCATE EXISTING SIGN				
0258	7684000000-N	8.000	EA	\$1,313.0000	\$10,504.00
	SIGNAL CABINET FOUNDATION				
0259	7686000000-N	10.000	EA	\$757.5000	\$7,575.00
	CONDUIT ENTRANCE INTO EXISTINGFOUNDATION				
0260	7696000000-N	9.000	EA	\$12,928.0000	\$116,352.00
	CONTROLLERS WITH CABINET (***** (TYPE 2070LX, BASE MOUNTED)				
0261	7744000000-N	89.000	EA	\$101.0000	\$8,989.00
	DETECTOR CARD (TYPE 170)				
0262	7901000000-N	9.000	EA	\$530.2500	\$4,772.25
	CABINET BASE EXTENDER				
0263	7960000000-N	1.000	EA	\$1,212.0000	\$1,212.00
	METAL POLE FOUNDATION REMOVAL				
0264	7972000000-N	1.000	EA	\$1,010.0000	\$1,010.00
	METAL POLE REMOVAL				
0265	7980000000-N	9.000	EA	\$1,515.0000	\$13,635.00
	GENERIC SIGNAL ITEM ETHERNET EDGE SWITCH				
0266	7980000000-N	6.000	EA	\$171.7000	\$1,030.20
	GENERIC SIGNAL ITEM JUNCTION BOX MARKER				
0267	7980000000-N	8.000	EA	\$656.5000	\$5,252.00
	GENERIC SIGNAL ITEM REMOVE RADIO INSTALLATION				

0268	7990000000-E	425.000 LF	\$2.7800	\$1,181.50
	GENERIC SIGNAL ITEM BACK PULL FIBER OPTIC CABLE			

Section 0001 Total \$8,392,506.20

Section 0003  
WALL ITEMS

0269	8801000000-E	1160.000 SF	\$85.0000	\$98,600.00
	MSE RETAINING WALL NO **** (1)			

0270	8802040000-E	325.000 SF	\$91.2600	\$29,659.50
	CIP GRAVITY RETAINING WALLS			

Section 0003 Total \$128,259.50

Section 0004  
STRUCTURE ITEMS

0271	8105540000-E	65.000 LF	\$1,100.0000	\$71,500.00
	3'-6" DIA DRILLED PIERS IN SOIL			

0272	8105640000-E	124.000 LF	\$1,100.0000	\$136,400.00
	3'-6" DIA DRILLED PIERS NOT IN SOIL			

0273	8113000000-N	3.000 EA	\$600.0000	\$1,800.00
	SID INSPECTIONS			

0274	8114000000-N	6.000 EA	\$600.0000	\$3,600.00
	SPT TESTING			

0275	8115000000-N	3.000 EA	\$1,500.0000	\$4,500.00
	CSL TESTING			

0276	8147000000-E	15562.000 SF	\$65.0000	\$1,011,530.00
	REINFORCED CONCRETE DECK SLAB			

0277	8161000000-E	25401.600 SF	\$1.0000	\$25,401.60
	GROOVING BRIDGE FLOORS			

0278	8182000000-E	297.400 CY	\$1,200.0000	\$356,880.00
	CLASS A CONCRETE (BRIDGE)			

0279	8210000000-N	1.000 LS	\$55,000.0000	\$55,000.00
	BRIDGE APPROACH SLABS, STATION***** (27+02.26 -L-)			

0280	8217000000-E	52536.000 LB	\$1.5000	\$78,804.00
	REINFORCING STEEL (BRIDGE)			

0281	8224000000-E	911.000 LB	\$1.7500	\$1,594.25
	EPOXY COATED REINFORCING STEEL (BRIDGE)			

0282	8238000000-E	7630.000 LB	\$2.5000	\$19,075.00
	SPIRAL COLUMN REINFORCING STEEL (BRIDGE)			

0283	8280000000-E	1.000 LS	\$1,400,000.0000	\$1,400,000.00
	APPROX ..... LBS STRUCTURALSTEEL			

0284	8328200000-E	16.000 EA	\$5,000.0000	\$80,000.00
	PILE DRIVING EQUIPMENT SETUP (HP 12 X 53)			

0285	8364000000-E	360.000 LF	\$65.0000	\$23,400.00
	HP12X53 STEEL PILES			

0286	8391000000-N	16.000 EA	\$150.0000	\$2,400.00
	STEEL PILE POINTS			

0287	8482000000-E	422.500 LF	\$150.0000	\$63,375.00
	THREE BAR METAL RAIL			
0288	8524000000-E	427.830 LF	\$152.0000	\$65,030.16
	*** CHAIN LINK FENCE (104")			
0289	8531000000-E	635.000 SY	\$95.0000	\$60,325.00
	4" SLOPE PROTECTION			
0290	8559000000-E	4.200 SY	\$600.0000	\$2,520.00
	CLASS II, SURFACE PREPARATION			
0291	8657000000-N	1.000 LS	\$75,000.0000	\$75,000.00
	ELASTOMERIC BEARINGS			
0292	8664000000-E	6.400 CF	\$2,500.0000	\$16,000.00
	SHOTCRETE REPAIRS			
0293	8678000000-E	1112.000 LF	\$155.0000	\$172,360.00
	EPOXY RESIN INJECTION			
0294	8692000000-N	1.000 LS	\$42,000.0000	\$42,000.00
	FOAM JOINT SEALS			
0295	8727000000-N	1.000 LS	\$55,550.0000	\$55,550.00
	ELECTRICAL CONDUIT SYSTEM FOR SIGNALS AT STA***** (27+02.26 -L-)			
0296	8881000000-E	62.100 CY	\$3,400.0000	\$211,140.00
	GENERIC STRUCTURE ITEM POLYESTER POLYMER CONCRETE MATERIALS			
0297	8892000000-E	647.000 SF	\$40.0000	\$25,880.00
	GENERIC STRUCTURE ITEM EPOXY COATING			
0298	8893000000-E	4.200 SY	\$150.0000	\$630.00
	GENERIC STRUCTURE ITEM CONCRETE DECK REPAIR FOR POLYESTER POLYMER CONCRETE OVERLAY			
0299	8893000000-E	2234.500 SY	\$56.0000	\$125,132.00
	GENERIC STRUCTURE ITEM PLACING & FINISHING POLYESTER POLYMER CONCRETE OVERLAY			
0300	8893000000-E	1464.500 SY	\$15.0000	\$21,967.50
	GENERIC STRUCTURE ITEM SCARIFYING BRIDGE DECK			
0301	8893000000-E	2234.500 SY	\$5.0000	\$11,172.50
	GENERIC STRUCTURE ITEM SHOTBLASTING BRIDGE DECK			
0302	8035000000-N	1.000 LS	\$125,000.0000	\$125,000.00
	REMOVAL OF EXISTING STRUCTURE AT STATION ***** (27+02.26 -L-)			
Section 0004 Total				\$4,344,967.01
Item Total				\$12,865,732.71



**ELECTRONIC BID SUBMISSION**

By submitting this bid electronically, I hereby acknowledge that all requirements included in the hard copy proposal, addendum, amendments, plans, standard specifications, supplemental specifications and special provisions are part of the bid and contract. Further, I acknowledge that I have read, understand, accept, acknowledge and agree to comply with all statements in this electronic bid.

=====

**NON-COLLUSION, DEBARMENT AND GIFT BAN CERTIFICATION**

The prequalified bidder declares (or certifies, verifies, or states) under penalty of perjury under the laws of the United States that neither he, nor any official, agent or employee has entered into any agreement, participated in any collusion, or otherwise taken any action which is in restraint of free competitive bidding in connection with any bid or contract, that the prequalified bidder has not been convicted of violating N.C.G.S. §133-24 within the last three years, and that the prequalified bidder intends to do the work with his own bonafide employees or subcontractors and will not bid for the benefit of another contractor.

By submitting this non-collusion, debarment and gift ban certification, the Contractor is attesting his status under penalty of perjury under the laws of the United States in accordance with the Debarment Certification attached, provided that the Debarment Certification also includes any required statements concerning exceptions that are applicable.

N.C.G.S. §133-32 and Executive Order 24 prohibit the offer to, or acceptance by, any State Employee of any gift from anyone with a contract with the State, or from any person seeking to do business with the State. By execution of any response in this procurement, you attest, for your entire organization and its employees or agents, that you are not aware that any such gift has been offered, accepted, or promised by any employees of your organization.

**DEBARMENT CERTIFICATION OF PREQUALIFIED BIDDER**

Conditions for certification:

1. The prequalified bidder shall provide immediate written notice to the Department if at any time the bidder learns that his certification was erroneous when he submitted his debarment certification or explanation that is file with the Department, or has become erroneous because of changed circumstances.
2. The terms covered transaction, debarred, suspended, ineligible, lower tier

covered transaction, participant, person, primary covered transaction, principal, proposal, and voluntarily excluded, as used in this provision, have the meanings set out in the Definitions and Coverage sections of the rules implementing Executive Order 12549. A copy of the Federal Rules requiring this certification and detailing the definitions and coverages may be obtained from the Contract Officer of the Department.

3. The prequalified bidder agrees by submitting this form, that he will not knowingly enter into any lower tier covered transaction with a person who is debarred, suspended, declared ineligible, or voluntarily excluded from participation in NCDOT contracts, unless authorized by the Department.

4. For Federal Aid projects, the prequalified bidder further agrees that by submitting this form he will include the Federal- Aid Provision titled Required Contract Provisions Federal-Aid Construction Contract (Form FHWA PR 1273) provided by the Department, without subsequent modification, in all lower tier covered transactions.

5. The prequalified bidder may rely upon a certification of a participant in a lower tier covered transaction that he is not debarred, suspended, ineligible, or voluntarily excluded from the covered transaction, unless he knows that the certification is erroneous. The bidder may decide the method and frequency by which he will determine the eligibility of his subcontractors.

6. Nothing contained in the foregoing shall be construed to require establishment of a system of records in order to render in good faith the certification required by this provision. The knowledge and information of a participant is not required to exceed that which is normally possessed by a prudent person in the ordinary course of business dealings.

7. Except as authorized in paragraph 6 herein, the Department may terminate any contract if the bidder knowingly enters into a lower tier covered transaction with a person who is suspended, debarred, ineligible, or voluntarily excluded from participation in this transaction, in addition to other remedies available by the Federal Government.

### **DEBARMENT CERTIFICATION**

The prequalified bidder certifies to the best of his knowledge and belief, that he and his principals:

a. Are not presently debarred, suspended, proposed for debarment, declared ineligible, or voluntarily excluded from covered transactions by any Federal department or agency;

b. Have not within a three-year period preceding this proposal been convicted of or had a civil judgment rendered against them for commission of fraud or a criminal offense in connection with obtaining, attempting to obtain, or performing a public (Federal, State or local) transaction or contract under a public transaction; violation of Federal or State antitrust statutes or

commission of embezzlement, theft, forgery, bribery, falsification or destruction of records; making false statements; or receiving stolen property;

c. Are not presently indicted for or otherwise criminally or civilly charged by a governmental entity (Federal, State or local) with commission of any of the offenses enumerated in paragraph b. of this certification; and

d. Have not within a three-year period preceding this proposal had one or more public transactions (Federal, State or local) terminated for cause or default.

e. Will submit a revised Debarment Certification immediately if his status changes and will show in his bid proposal an explanation for the change in status.

If the prequalified bidder cannot certify that he is not debarred, he shall provide an explanation with this submittal. An explanation will not necessarily result in denial of participation in a contract.

Failure to submit a non-collusion and debarment certification will result in the prequalified bidder's bid being considered non-responsive.

**EXPLANATION:**

=====

### Award Limits on Multiple Projects

By answering YES to this statement, the bidder acknowledges that they are using the award limits on multiple projects? **Yes**  **No**

A bidder who desires to bid on more than one project on which bids are to be opened on the same date, and who also desires to avoid receiving an award of more projects than he is equipped to handle, may bid on any number of projects but may limit the total amount of work awarded to him on selected projects by completing the AWARD LIMITS ON MULTIPLE PROJECTS.

The Award Limits on Multiple Projects must be filled in on each project bid for which the Bidder desires protection.

It is the desire of the Bidder to be awarded contracts, the value of which will not exceed a total of     for those

projects indicated herein, for which bids will be opened on     (MM/DD/YY)

The Award Limits shall apply to the following projects:

Contract Number  
County

Contract Number  
County

Contract Number  
County

Contract Number  
County

Contract Number  
County

Contract Number  
County

It is agreed that if I am (we are) the low Bidder(s) on indicated projects, the total value of which is more than the above stipulated award limits, the Board of Transportation will award me (us) projects from among those indicated

that have a total value not to exceed the award limit and will result in the lowest total bids to the Department of Transportation.

### DBE List Summary

Project: NHPP-040-4(161)220  
Bid Total: 12,865,732.71  
Goal: 5.00% (643,286.64)  
Total Entered: 5.13% (659,639.55)

Bidder ID: 9105  
Business Name: Zachry Construction Corp

<b>ID</b>	<b>Name</b>	<b>Is Supplier?</b>	<b>Item Count</b>	<b>Amount</b>	<b>Is Complete?</b>
11572	CRUZ BROTHERS CONCRETE, INC.	False	10	467,620.50	True
1991	MCCAIN STRIPING SERVICE INC	False	28	192,019.05	True

Name: CRUZ BROTHERS CONCRETE, INC. ID: 11572

Address: 1572 PAYNE ROAD/LOT 75 LOT 75 , GRAHAM, NC 27253

Used As: SubContractor DBE Items Total:\$467,620.50

**Items for CRUZ BROTHERS CONCRETE, INC.**

0001 ROADWAY ITEMS					
0001	0000100000-N	1.000	LS	\$1,500.0000	\$1,500.00
	MOBILIZATION				
0053	2451000000-N	3.000	EA	\$850.0000	\$2,550.00
	CONCRETE TRANSITIONAL SECTION FOR DROP INLET				
0054	2535000000-E	30.000	LF	\$26.0000	\$780.00
	**"X **" CONCRETE CURB (8" X 12")				
0055	2549000000-E	8970.000	LF	\$21.6500	\$194,200.50
	2'-6" CONCRETE CURB & GUTTER				
0056	2591000000-E	2260.000	SY	\$41.2500	\$93,225.00
	4" CONCRETE SIDEWALK				
0057	2605000000-N	54.000	EA	\$2,100.0000	\$113,400.00
	CONCRETE CURB RAMPS				
0058	2612000000-E	40.000	SY	\$82.0000	\$3,280.00
	6" CONCRETE DRIVEWAY				
0059	2627000000-E	140.000	SY	\$41.2500	\$5,775.00
	4" CONCRETE ISLAND COVER				
0060	2647000000-E	140.000	SY	\$71.5000	\$10,010.00
	5" MONOLITHIC CONCRETE ISLANDS (SURFACE MOUNTED)				
0061	2655000000-E	600.000	SY	\$71.5000	\$42,900.00
	5" MONOLITHIC CONCRETE ISLANDS (KEYED IN)				
Section 0001 Total					\$467,620.50
Item Total					\$467,620.50

Name: MCCAIN STRIPING SERVICE INC ID: 1991

Address: 5711 CRAVEN ROAD , BROWNS SUMMIT, NC 27214

Used As: SubContractor DBE Items Total:\$192,019.05

**Items for MCCAIN STRIPING SERVICE INC**

0001 ROADWAY ITEMS					
0001	0000100000-N	1.000	LS	\$27,500.0000	\$27,500.00
	MOBILIZATION				
0120	4650000000-N	570.000	EA	\$4.7800	\$2,724.60
	TEMPORARY RAISED PAVEMENT MARKERS				
0121	4685000000-E	13979.000	LF	\$0.8700	\$12,161.73
	THERMOPLASTIC PAVEMENT MARKING LINES (4", 90 MILS)				
0122	4688000000-E	10248.000	LF	\$0.9900	\$10,145.52
	THERMOPLASTIC PAVEMENT MARKING LINES (6", 90 MILS)				
0123	4695000000-E	3397.000	LF	\$1.9500	\$6,624.15
	THERMOPLASTIC PAVEMENT MARKING LINES (8", 90 MILS)				
0124	4700000000-E	995.000	LF	\$3.5000	\$3,482.50
	THERMOPLASTIC PAVEMENT MARKING LINES (12", 90 MILS)				
0125	4720000000-E	12.000	EA	\$90.0000	\$1,080.00
	THERMOPLASTIC PAVEMENT MARKING CHARACTER (90 MILS)				
0126	4725000000-E	99.000	EA	\$90.0000	\$8,910.00
	THERMOPLASTIC PAVEMENT MARKING SYMBOL (90 MILS)				
0127	4726110000-E	24.000	EA	\$150.0000	\$3,600.00
	HEATED-IN-PLACE THERMOPLASTIC PAVEMENT MARKING SYMBOL				
0128	4770000000-E	1617.000	LF	\$3.0000	\$4,851.00
	COLD APPLIED PLASTIC PAVEMENT MARKING LINES, TYPE ** (4") (II)				
0129	4770000000-E	310.000	LF	\$3.5000	\$1,085.00
	COLD APPLIED PLASTIC PAVEMENT MARKING LINES, TYPE ** (4") (IV)				
0130	4805000000-N	10.000	EA	\$200.0000	\$2,000.00
	COLD APPLIED PLASTIC PAVEMENT MARKING SYMBOL, TYPE ** (II)				
0131	4805000000-N	2.000	EA	\$390.0000	\$780.00
	COLD APPLIED PLASTIC PAVEMENT MARKING SYMBOL, TYPE ** (IV)				
0132	4810000000-E	33600.000	LF	\$0.3500	\$11,760.00
	PAINT PAVEMENT MARKING LINES (4")				
0133	4815000000-E	33000.000	LF	\$0.4700	\$15,510.00
	PAINT PAVEMENT MARKING LINES (6")				
0134	4820000000-E	1820.000	LF	\$1.0000	\$1,820.00
	PAINT PAVEMENT MARKING LINES (8")				
0135	4825000000-E	400.000	LF	\$2.0000	\$800.00
	PAINT PAVEMENT MARKING LINES (12")				
0136	4835000000-E	730.000	LF	\$2.5000	\$1,825.00
	PAINT PAVEMENT MARKING LINES (24")				



0137	4840000000-N	36.000	EA	\$35.0000	\$1,260.00
	PAINT PAVEMENT MARKING CHARAC-TER				
0138	4845000000-N	109.000	EA	\$35.0000	\$3,815.00
	PAINT PAVEMENT MARKING SYMBOL				
0139	4850000000-E	5200.000	LF	\$0.7500	\$3,900.00
	REMOVAL OF PAVEMENT MARKING LINES (4")				
0140	4855000000-E	22000.000	LF	\$1.1000	\$24,200.00
	REMOVAL OF PAVEMENT MARKING LINES (6")				
0141	4860000000-E	800.000	LF	\$1.5000	\$1,200.00
	REMOVAL OF PAVEMENT MARKING LINES (8")				
0142	4870000000-E	120.000	LF	\$3.7500	\$450.00
	REMOVAL OF PAVEMENT MARKING LINES (24")				
0143	4875000000-N	18.000	EA	\$50.0000	\$900.00
	REMOVAL OF PAVEMENT MARKING SYMBOLS & CHARACTERS				
0144	4891000000-E	4183.000	LF	\$6.7500	\$28,235.25
	GENERIC PAVEMENT MARKING ITEM THERMOPLASTIC PAVEMENT MARKING LINES (24", 90 MILS)				
0145	4900000000-N	35.000	EA	\$4.7800	\$167.30
	PERMANENT RAISED PAVEMENT MARKERS				
0146	4905000000-N	351.000	EA	\$32.0000	\$11,232.00
	SNOWPLOWABLE PAVEMENT MARKERS				
Section 0001 Total					\$192,019.05
Item Total					\$192,019.05

THIS PROPOSAL CONTAINS THE FOLLOWING ERRORS/WARNINGS (IF ANY)

This Bid contains 1 amendment files

000001 03/04/2021 ADD ITEM

**Electronic Bid Submission**

By submitting this bid electronically, I hereby acknowledge that all requirements included in the hard copy proposal, addendum, amendments, plans, standard specifications, supplemental specifications and special provisions are part of the bid and contract. Further, I acknowledge that I have read, understand, accept, acknowledge and agree to comply with all statements in this electronic bid.

I hereby certify that I have the authority to submit this bid.

Signature \_\_\_\_\_

Agency \_\_\_\_\_

Date \_\_\_\_\_

Signature \_\_\_\_\_

Agency \_\_\_\_\_

Date \_\_\_\_\_

Signature \_\_\_\_\_

Agency \_\_\_\_\_

Date \_\_\_\_\_

## Contract Item Sheets For C204603

Line #	ItemNumber	Sec #	Description	Quantity Unit	Unit Bid Price	Amount Bid
<b>ROADWAY ITEMS</b>						
0001	0000100000-N	800	MOBILIZATION	Lump Sum LS	643,000.01	643,000.01
0002	0000400000-N	801	CONSTRUCTION SURVEYING	Lump Sum LS	175,000.00	175,000.00
0003	0030000000-N	SP	TYPE II MODIFIED APPROACH FILL, STATION ***** (27+02.26 -L-)	Lump Sum LS	40,000.00	40,000.00
0004	0036000000-E	225	UNDERCUT EXCAVATION	2,475 CY	9.00	22,275.00
0005	0043000000-N	226	GRADING	Lump Sum LS	857,353.77	857,353.77
0006	0050000000-E	226	SUPPLEMENTARY CLEARING & GRUB- BING	1 ACR	8,000.00	8,000.00
0007	0134000000-E	240	DRAINAGE DITCH EXCAVATION	25 CY	20.00	500.00
0008	0195000000-E	265	SELECT GRANULAR MATERIAL	1,975 CY	22.00	43,450.00
0009	0196000000-E	270	GEOTEXTILE FOR SOIL STABILIZA- TION	3,075 SY	1.25	3,843.75
0010	0199000000-E	SP	TEMPORARY SHORING	140 SF	80.00	11,200.00
0011	0255000000-E	SP	GENERIC GRADING ITEM HAULING & DISPOSAL OF PETRO- LEUM CONTAMINATED SOIL	60 TON	150.00	9,000.00
0012	0318000000-E	300	FOUNDATION CONDITIONING MATE- RIAL, MINOR STRUCTURES	460 TON	20.00	9,200.00
0013	0320000000-E	300	FOUNDATION CONDITIONING GEO- TEXTILE	1,420 SY	2.50	3,550.00
0014	0343000000-E	310	15" SIDE DRAIN PIPE	1,024 LF	50.00	51,200.00
0015	0344000000-E	310	18" SIDE DRAIN PIPE	124 LF	55.00	6,820.00
0016	0345000000-E	310	24" SIDE DRAIN PIPE	280 LF	60.00	16,800.00
0017	0348000000-E	310	***" SIDE DRAIN PIPE ELBOWS (15")	6 EA	300.00	1,800.00
0018	0378000000-E	310	24" RC PIPE CULVERTS, CLASS III	44 LF	85.00	3,740.00

Line #	ItemNumber	Sec #	Description	Quantity Unit	Unit Bid Price	Amount Bid
0019	0448200000-E	310	15" RC PIPE CULVERTS, CLASS IV	1,956 LF	70.00	136,920.00
0020	0448300000-E	310	18" RC PIPE CULVERTS, CLASS IV	240 LF	80.00	19,200.00
0021	0448400000-E	310	24" RC PIPE CULVERTS, CLASS IV	584 LF	100.00	58,400.00
0022	0995000000-E	340	PIPE REMOVAL	2,034 LF	13.00	26,442.00
0023	1099500000-E	505	SHALLOW UNDERCUT	350 CY	22.00	7,700.00
0024	1099700000-E	505	CLASS IV SUBGRADE STABILIZATION	650 TON	22.00	14,300.00
0025	1220000000-E	545	INCIDENTAL STONE BASE	1,000 TON	25.00	25,000.00
0026	1297000000-E	607	MILLING ASPHALT PAVEMENT, **** DEPTH (1-1/2")	21,400 SY	2.00	42,800.00
0027	1297000000-E	607	MILLING ASPHALT PAVEMENT, **** DEPTH (3")	19,150 SY	3.00	57,450.00
0028	1330000000-E	607	INCIDENTAL MILLING	2,110 SY	8.50	17,935.00
0029	1491000000-E	610	ASPHALT CONC BASE COURSE, TYPE B25.0C	7,500 TON	75.00	562,500.00
0030	1503000000-E	610	ASPHALT CONC INTERMEDIATE COURSE, TYPE I19.0C	5,100 TON	75.00	382,500.00
0031	1519000000-E	610	ASPHALT CONC SURFACE COURSE, TYPE S9.5B	5,900 TON	70.00	413,000.00
0032	1523000000-E	610	ASPHALT CONC SURFACE COURSE, TYPE S9.5C	1,200 TON	95.00	114,000.00
0033	1524200000-E	610	ASPHALT CONC SURFACE COURSE, TYPE S9.5D	2,100 TON	85.00	178,500.00
0034	1575000000-E	620	ASPHALT BINDER FOR PLANT MIX	1,195 TON	390.00	466,050.00
0035	1577000000-E	620	POLYMER MODIFIED ASPHALT BINDER FOR PLANT MIX	120 TON	545.00	65,400.00
0036	1693000000-E	654	ASPHALT PLANT MIX, PAVEMENT REPAIR	1,000 TON	80.00	80,000.00

Line #	ItemNumber	Sec #	Description	Quantity Unit	Unit Bid Price	Amount Bid
0037	1840000000-E	665	MILLED RUMBLE STRIPS (ASPHALT CONCRETE)	6,900 LF	0.76	5,244.00
0038	2022000000-E	815	SUBDRAIN EXCAVATION	22.4 CY	20.00	448.00
0039	2026000000-E	815	GEOTEXTILE FOR SUBSURFACE DRAINS	100 SY	5.00	500.00
0040	2036000000-E	815	SUBDRAIN COARSE AGGREGATE	16.8 CY	65.00	1,092.00
0041	2044000000-E	815	6" PERFORATED SUBDRAIN PIPE	100 LF	15.00	1,500.00
0042	2070000000-N	815	SUBDRAIN PIPE OUTLET	1 EA	350.00	350.00
0043	2077000000-E	815	6" OUTLET PIPE	6 LF	35.00	210.00
0044	2264000000-E	840	PIPE PLUGS	0.029 CY	5,500.00	159.50
0045	2286000000-N	840	MASONRY DRAINAGE STRUCTURES	64 EA	3,000.00	192,000.00
0046	2308000000-E	840	MASONRY DRAINAGE STRUCTURES	2.4 LF	450.00	1,080.00
0047	2363000000-N	840	FRAME WITH TWO GRATES, STD 840.**** (840.15)	6 EA	700.00	4,200.00
0048	2364000000-N	840	FRAME WITH TWO GRATES, STD 840.16	6 EA	700.00	4,200.00
0049	2365000000-N	840	FRAME WITH TWO GRATES, STD 840.22	1 EA	625.00	625.00
0050	2374000000-N	840	FRAME WITH GRATE & HOOD, STD 840.03, TYPE ** (E)	8 EA	800.00	6,400.00
0051	2374000000-N	840	FRAME WITH GRATE & HOOD, STD 840.03, TYPE ** (F)	25 EA	800.00	20,000.00
0052	2374000000-N	840	FRAME WITH GRATE & HOOD, STD 840.03, TYPE ** (G)	24 EA	800.00	19,200.00
0053	2451000000-N	852	CONCRETE TRANSITIONAL SECTION FOR DROP INLET	3 EA	850.00	2,550.00

Line #	ItemNumber	Sec #	Description	Quantity Unit	Unit Bid Price	Amount Bid
0054	2535000000-E	846	***X *** CONCRETE CURB (8" X 12")	30 LF	26.00	780.00
0055	2549000000-E	846	2'-6" CONCRETE CURB & GUTTER	8,970 LF	21.65	194,200.50
0056	2591000000-E	848	4" CONCRETE SIDEWALK	2,260 SY	41.25	93,225.00
0057	2605000000-N	848	CONCRETE CURB RAMPS	54 EA	2,100.00	113,400.00
0058	2612000000-E	848	6" CONCRETE DRIVEWAY	40 SY	82.00	3,280.00
0059	2627000000-E	852	4" CONCRETE ISLAND COVER	140 SY	41.25	5,775.00
0060	2647000000-E	852	5" MONOLITHIC CONCRETE ISLANDS (SURFACE MOUNTED)	140 SY	71.50	10,010.00
0061	2655000000-E	852	5" MONOLITHIC CONCRETE ISLANDS (KEYED IN)	600 SY	71.50	42,900.00
0062	2710000000-N	854	CONCRETE BARRIER TRANSITION SECTION	2 EA	2,500.00	5,000.00
0063	2724000000-E	857	PRECAST REINFORCED CONCRETE BARRIER, SINGLE FACED	140 LF	200.00	28,000.00
0064	2800000000-N	858	ADJUSTMENT OF CATCH BASINS	1 EA	4,500.00	4,500.00
0065	3030000000-E	862	STEEL BEAM GUARDRAIL	700 LF	18.52	12,964.00
0066	3045000000-E	862	STEEL BEAM GUARDRAIL, SHOP CURVED	175 LF	19.54	3,419.50
0067	3145000000-E	862	EXTRA LENGTH GUARDRAIL POST (** STEEL) (8')	41 EA	65.97	2,704.77
0068	3150000000-N	862	ADDITIONAL GUARDRAIL POSTS	5 EA	1.02	5.10
0069	3195000000-N	862	GUARDRAIL END UNITS, TYPE AT-1	3 EA	507.50	1,522.50
0070	3215000000-N	SP	GUARDRAIL ANCHOR UNITS, TYPE III	2 EA	1,725.50	3,451.00
0071	3287000000-N	SP	GUARDRAIL END UNITS, TYPE TL-3	3 EA	2,537.50	7,612.50

Line #	ItemNumber	Sec #	Description	Quantity Unit	Unit Bid Price	Amount Bid
0072	3317000000-N	SP	GUARDRAIL ANCHOR UNITS, TYPE B-77	2 EA	1,700.13	3,400.26
0073	3360000000-E	863	REMOVE EXISTING GUARDRAIL	605 LF	0.91	550.55
0074	3503000000-E	866	WOVEN WIRE FENCE, 47" FABRIC	700 LF	6.00	4,200.00
0075	3509000000-E	866	4" TIMBER FENCE POSTS, 7'-6" LONG	35 EA	22.00	770.00
0076	3515000000-E	866	5" TIMBER FENCE POSTS, 8'-0" LONG	28 EA	38.00	1,064.00
0077	3575000000-E	SP	GENERIC FENCING ITEM STEEL PIPE HANDRAIL	50 LF	225.00	11,250.00
0078	3649000000-E	876	RIP RAP, CLASS B	30 TON	45.00	1,350.00
0079	3656000000-E	876	GEOTEXTILE FOR DRAINAGE	1,425 SY	3.50	4,987.50
0080	4048000000-E	902	REINFORCED CONCRETE SIGN FOUNDATIONS	2 CY	250.00	500.00
0081	4054000000-E	902	PLAIN CONCRETE SIGN FOUNDATIONS	1 CY	250.00	250.00
0082	4057000000-E	SP	OVERHEAD FOOTING	36 CY	1,525.00	54,900.00
0083	4060000000-E	903	SUPPORTS, BREAKAWAY STEEL BEAM	1,886 LB	4.12	7,770.32
0084	4066000000-E	903	SUPPORTS, SIMPLE STEEL BEAM	317 LB	4.12	1,306.04
0085	4072000000-E	903	SUPPORTS, 3-LB STEEL U-CHANNEL	900 LF	6.18	5,562.00
0086	4082100000-N	906	SUPPORTS, OVERHEAD SIGN STRUCTURE AT STA ***** (23+15 -L-)	Lump Sum LS	139,050.00	139,050.00
0087	4082100000-N	906	SUPPORTS, OVERHEAD SIGN STRUCTURE AT STA ***** (30+75 -L-)	Lump Sum LS	103,000.00	103,000.00
0088	4096000000-N	904	SIGN ERECTION, TYPE D	4 EA	103.00	412.00
0089	4102000000-N	904	SIGN ERECTION, TYPE E	51 EA	72.10	3,677.10

Line #	ItemNumber	Sec #	Description	Quantity Unit	Unit Bid Price	Amount Bid
0090	4108000000-N	904	SIGN ERECTION, TYPE F	2 EA	103.00	206.00
0091	4109000000-N	904	SIGN ERECTION, TYPE *** (OVER-HEAD) (A)	4 EA	1.03	4.12
0092	4110000000-N	904	SIGN ERECTION, TYPE *** (GROUND MOUNTED) (A)	6 EA	515.00	3,090.00
0093	4110000000-N	904	SIGN ERECTION, TYPE *** (GROUND MOUNTED) (B)	1 EA	360.50	360.50
0094	4116100000-N	904	SIGN ERECTION, RELOCATE TYPE **** (GROUND MOUNTED) (GM RESTAURANT LOGO SIGNS)	1 EA	515.00	515.00
0095	4149000000-N	907	DISPOSAL OF SIGN SYSTEM, OVER-HEAD	1 EA	3,605.00	3,605.00
0096	4152000000-N	907	DISPOSAL OF SIGN SYSTEM, STEEL BEAM	2 EA	257.50	515.00
0097	4155000000-N	907	DISPOSAL OF SIGN SYSTEM, U-CHANNEL	56 EA	4.12	230.72
0098	4158000000-N	907	DISPOSAL OF SIGN SYSTEM, WOOD	2 EA	4.12	8.24
0099	4192000000-N	907	DISPOSAL OF SUPPORT, U-CHANNEL	1 EA	4.12	4.12
0100	4400000000-E	1110	WORK ZONE SIGNS (STATIONARY)	524 SF	4.34	2,274.16
0101	4405000000-E	1110	WORK ZONE SIGNS (PORTABLE)	624 SF	8.16	5,091.84
0102	4410000000-E	1110	WORK ZONE SIGNS (BARRICADE MOUNTED)	142 SF	5.10	724.20
0103	4415000000-N	1115	FLASHING ARROW BOARD	6 EA	4,250.00	25,500.00
0104	4420000000-N	1120	PORTABLE CHANGEABLE MESSAGE SIGN	6 EA	14,550.00	87,300.00
0105	4422000000-N	1120	PORTABLE CHANGEABLE MESSAGE SIGN (SHORT TERM)	40 DAY	35.70	1,428.00
0106	4430000000-N	1130	DRUMS	580 EA	50.00	29,000.00



Line #	ItemNumber	Sec #	Description	Quantity Unit	Unit Bid Price	Amount Bid
0107	4434000000-N	SP	SEQUENTIAL FLASHING WARNING LIGHTS	40 EA	100.00	4,000.00
0108	4435000000-N	1135	CONES	60 EA	15.00	900.00
0109	4445000000-E	1145	BARRICADES (TYPE III)	96 LF	25.00	2,400.00
0110	4447000000-E	SP	PEDESTRIAN CHANNELIZING DEVICES	72 LF	25.00	1,800.00
0111	4455000000-N	1150	FLAGGER	480 DAY	300.00	144,000.00
0112	4465000000-N	1160	TEMPORARY CRASH CUSHIONS	7 EA	5,000.00	35,000.00
0113	4470000000-N	1160	REMOVE & RESET TEMPORARY CRASH CUSHION	3 EA	3,000.00	9,000.00
0114	4480000000-N	1165	TMA	4 EA	40,000.00	160,000.00
0115	4485000000-E	1170	PORTABLE CONCRETE BARRIER	3,205 LF	40.00	128,200.00
0116	4490000000-E	1170	PORTABLE CONCRETE BARRIER (ANCHORED)	1,150 LF	66.00	75,900.00
0117	4505000000-E	1170	REMOVE & RESET PORTABLE CONCRETE BARRIER (ANCHORED)	410 LF	9.00	3,690.00
0118	4600000000-N	SP	GENERIC TRAFFIC CONTROL ITEM AUDIBLE WARNING DEVICES	6 EA	200.00	1,200.00
0119	4600000000-N	SP	GENERIC TRAFFIC CONTROL ITEM PEDESTRIAN TRANSPORT SERVICE (PER TRIP)	1,500 EA	0.01	15.00
0120	4650000000-N	1251	TEMPORARY RAISED PAVEMENT MARKERS	570 EA	4.78	2,724.60
0121	4685000000-E	1205	THERMOPLASTIC PAVEMENT MARKING LINES (4", 90 MILS)	13,979 LF	0.87	12,161.73
0122	4688000000-E	1205	THERMOPLASTIC PAVEMENT MARKING LINES (6", 90 MILS)	10,248 LF	0.99	10,145.52
0123	4695000000-E	1205	THERMOPLASTIC PAVEMENT MARKING LINES (8", 90 MILS)	3,397 LF	1.95	6,624.15
0124	4700000000-E	1205	THERMOPLASTIC PAVEMENT MARKING LINES (12", 90 MILS)	995 LF	3.50	3,482.50

Line #	ItemNumber	Sec #	Description	Quantity Unit	Unit Bid Price	Amount Bid
0125	4720000000-E	1205	THERMOPLASTIC PAVEMENT MARKING CHARACTER (90 MILS)	12 EA	90.00	1,080.00
0126	4725000000-E	1205	THERMOPLASTIC PAVEMENT MARKING SYMBOL (90 MILS)	99 EA	90.00	8,910.00
0127	4726110000-E	1205	HEATED-IN-PLACE THERMOPLASTIC PAVEMENT MARKING SYMBOL (90 MILS)	24 EA	150.00	3,600.00
0128	4770000000-E	1205	COLD APPLIED PLASTIC PAVEMENT MARKING LINES, TYPE ** (4") (II)	1,617 LF	3.00	4,851.00
0129	4770000000-E	1205	COLD APPLIED PLASTIC PAVEMENT MARKING LINES, TYPE ** (4") (IV)	310 LF	3.50	1,085.00
0130	4805000000-N	1205	COLD APPLIED PLASTIC PAVEMENT MARKING SYMBOL, TYPE ** (II)	10 EA	200.00	2,000.00
0131	4805000000-N	1205	COLD APPLIED PLASTIC PAVEMENT MARKING SYMBOL, TYPE ** (IV)	2 EA	390.00	780.00
0132	4810000000-E	1205	PAINT PAVEMENT MARKING LINES (4")	33,600 LF	0.35	11,760.00
0133	4815000000-E	1205	PAINT PAVEMENT MARKING LINES (6")	33,000 LF	0.47	15,510.00
0134	4820000000-E	1205	PAINT PAVEMENT MARKING LINES (8")	1,820 LF	1.00	1,820.00
0135	4825000000-E	1205	PAINT PAVEMENT MARKING LINES (12")	400 LF	2.00	800.00
0136	4835000000-E	1205	PAINT PAVEMENT MARKING LINES (24")	730 LF	2.50	1,825.00
0137	4840000000-N	1205	PAINT PAVEMENT MARKING CHARACTER	36 EA	35.00	1,260.00
0138	4845000000-N	1205	PAINT PAVEMENT MARKING SYMBOL	109 EA	35.00	3,815.00
0139	4850000000-E	1205	REMOVAL OF PAVEMENT MARKING LINES (4")	5,200 LF	0.75	3,900.00
0140	4855000000-E	1205	REMOVAL OF PAVEMENT MARKING LINES (6")	22,000 LF	1.10	24,200.00

Line #	ItemNumber	Sec #	Description	Quantity Unit	Unit Bid Price	Amount Bid
0141	4860000000-E	1205	REMOVAL OF PAVEMENT MARKING LINES (8")	800 LF	1.50	1,200.00
0142	4870000000-E	1205	REMOVAL OF PAVEMENT MARKING LINES (24")	120 LF	3.75	450.00
0143	4875000000-N	1205	REMOVAL OF PAVEMENT MARKING SYMBOLS & CHARACTERS	18 EA	50.00	900.00
0144	4891000000-E	1205	GENERIC PAVEMENT MARKING ITEM THERMOPLASTIC PAVEMENT MARKING LINES (24", 90 MILS)	4,183 LF	6.75	28,235.25
0145	4900000000-N	1251	PERMANENT RAISED PAVEMENT MARKERS	35 EA	4.78	167.30
0146	4905000000-N	1253	SNOWPLOWABLE PAVEMENT MARKERS	351 EA	32.00	11,232.00
0147	5070000000-N	SP	STANDARD FOUNDATION ***** (TYPE R1)	3 EA	732.25	2,196.75
0148	5155000000-E	1409	ELECTRICAL DUCT, TYPE BD, SIZE ***** (2")	155 LF	13.13	2,035.15
0149	5160000000-E	1409	ELECTRICAL DUCT, TYPE JA, SIZE ***** (3")	45 LF	17.17	772.65
0150	5160000000-E	1409	ELECTRICAL DUCT, TYPE JA, SIZE ***** (4")	135 LF	25.25	3,408.75
0151	5185000000-E	1410	** #2 W/G FEEDER CIRCUIT (2)	310 LF	7.32	2,269.20
0152	5215000000-E	1410	** #4 W/G FEEDER CIRCUIT IN ***** CONDUIT (2, 1.5")	650 LF	10.35	6,727.50
0153	5220000000-E	1410	** #2 W/G FEEDER CIRCUIT IN ***** CONDUIT (2, 1.5")	330 LF	11.87	3,917.10
0154	5240000000-N	1411	ELECTRICAL JUNCTION BOXES ***** (IG18)	3 EA	329.26	987.78
0155	5240000000-N	1411	ELECTRICAL JUNCTION BOXES ***** (LS18)	3 EA	329.26	987.78

Line #	ItemNumber	Sec #	Description	Quantity Unit	Unit Bid Price	Amount Bid
0156	5255000000-N	1413	PORTABLE LIGHTING	Lump Sum LS	50,000.00	50,000.00
0157	5260000000-N	SP	GENERIC LIGHTING ITEM LUMINAIRE STORAGE	Lump Sum LS	2,525.00	2,525.00
0158	5270000000-N	SP	GENERIC LIGHTING ITEM RELOCATE LIGHT STANDARD	1 EA	1,818.00	1,818.00
0159	5270000000-N	SP	GENERIC LIGHTING ITEM REMOVE LIGHT STANDARD FOUNDATION	1 EA	909.00	909.00
0160	5270000000-N	SP	GENERIC LIGHTING ITEM REMOVE SINGLE ARM LIGHT STANDARD	1 EA	606.00	606.00
0161	5325800000-E	1510	8" WATER LINE	10 LF	150.00	1,500.00
0162	5326200000-E	1510	12" WATER LINE	325 LF	165.00	53,625.00
0163	5329000000-E	1510	DUCTILE IRON WATER PIPE FITTINGS	3,115 LB	6.00	18,690.00
0164	5540000000-E	1515	6" VALVE	1 EA	2,500.00	2,500.00
0165	5546000000-E	1515	8" VALVE	1 EA	3,500.00	3,500.00
0166	5558000000-E	1515	12" VALVE	4 EA	5,000.00	20,000.00
0167	5571000000-E	1515	*** TAPPING SLEEVE & VALVE (2")	1 EA	7,500.00	7,500.00
0168	5648000000-N	1515	RELOCATE WATER METER	8 EA	2,500.00	20,000.00
0169	5649000000-N	1515	RECONNECT WATER METER	2 EA	2,000.00	4,000.00
0170	5653100000-E	1515	RELOCATE *** DCV BACKFLOW PRE- VENTION ASSEMBLY (1")	3 EA	3,250.00	9,750.00
0171	5653100000-E	1515	RELOCATE *** DCV BACKFLOW PRE- VENTION ASSEMBLY (2")	3 EA	3,500.00	10,500.00
0172	5672000000-N	1515	RELOCATE FIRE HYDRANT	3 EA	3,500.00	10,500.00
0173	5673000000-E	1515	FIRE HYDRANT LEG	80 LF	200.00	16,000.00

Line #	ItemNumber	Sec #	Description	Quantity Unit	Unit Bid Price	Amount Bid
0174	5686000000-E	1515	*** WATER SERVICE LINE (1")	70 LF	60.00	4,200.00
0175	5686000000-E	1515	*** WATER SERVICE LINE (2")	95 LF	65.00	6,175.00
0176	5691200000-E	1520	6" SANITARY GRAVITY SEWER	10 LF	300.00	3,000.00
0177	5691300000-E	1520	8" SANITARY GRAVITY SEWER	165 LF	350.00	57,750.00
0178	5775000000-E	1525	4' DIA UTILITY MANHOLE	3 EA	8,000.00	24,000.00
0179	5801000000-E	1530	ABANDON 8" UTILITY PIPE	134 LF	40.00	5,360.00
0180	5828000000-N	1530	REMOVE UTILITY MANHOLE	2 EA	4,500.00	9,000.00
0181	5882000000-N	SP	GENERIC UTILITY ITEM 12" INSERT VALVE	2 EA	25,000.00	50,000.00
0182	6000000000-E	1605	TEMPORARY SILT FENCE	7,880 LF	3.00	23,640.00
0183	6006000000-E	1610	STONE FOR EROSION CONTROL, CLASS A	525 TON	45.00	23,625.00
0184	6009000000-E	1610	STONE FOR EROSION CONTROL, CLASS B	465 TON	45.00	20,925.00
0185	6012000000-E	1610	SEDIMENT CONTROL STONE	790 TON	26.00	20,540.00
0186	6015000000-E	1615	TEMPORARY MULCHING	7 ACR	1,217.19	8,520.33
0187	6018000000-E	1620	SEED FOR TEMPORARY SEEDING	500 LB	2.44	1,220.00
0188	6021000000-E	1620	FERTILIZER FOR TEMPORARY SEED- ING	3.5 TON	949.41	3,322.94
0189	6024000000-E	1622	TEMPORARY SLOPE DRAINS	200 LF	17.42	3,484.00
0190	6029000000-E	SP	SAFETY FENCE	600 LF	1.47	882.00
0191	6030000000-E	1630	SILT EXCAVATION	900 CY	7.69	6,921.00
0192	6036000000-E	1631	MATTING FOR EROSION CONTROL	9,680 SY	1.47	14,229.60
0193	6037000000-E	SP	COIR FIBER MAT	100 SY	6.57	657.00

Line #	ItemNumber	Sec #	Description	Quantity Unit	Unit Bid Price	Amount Bid
0194	6042000000-E	1632	1/4" HARDWARE CLOTH	3,240 LF	2.44	7,905.60
0195	6071012000-E	SP	COIR FIBER WATTLE	90 LF	9.49	854.10
0196	6071020000-E	SP	POLYACRYLAMIDE (PAM)	60 LB	14.61	876.60
0197	6071030000-E	1640	COIR FIBER BAFFLE	105 LF	6.57	689.85
0198	6071050000-E	SP	*** SKIMMER (1-1/2")	1 EA	1,589.92	1,589.92
0199	6084000000-E	1660	SEEDING & MULCHING	6 ACR	1,777.09	10,662.54
0200	6087000000-E	1660	MOWING	6 ACR	121.72	730.32
0201	6090000000-E	1661	SEED FOR REPAIR SEEDING	100 LB	6.57	657.00
0202	6093000000-E	1661	FERTILIZER FOR REPAIR SEEDING	0.25 TON	1,066.26	266.57
0203	6096000000-E	1662	SEED FOR SUPPLEMENTAL SEEDING	150 LB	6.57	985.50
0204	6108000000-E	1665	FERTILIZER TOPDRESSING	4.5 TON	1,071.13	4,820.09
0205	6114500000-N	1667	SPECIALIZED HAND MOWING	10 MHR	82.77	827.70
0206	6117000000-N	SP	RESPONSE FOR EROSION CONTROL	25 EA	438.19	10,954.75
0207	6117500000-N	SP	CONCRETE WASHOUT STRUCTURE	12 EA	750.00	9,000.00
0208	6132000000-N	SP	GENERIC EROSION CONTROL ITEM FABRIC INSERT INLET PROTECTION DEVICE	45 EA	131.46	5,915.70
0209	6132000000-N	SP	GENERIC EROSION CONTROL ITEM FABRIC INSERT INLET PROTECTION DEVICE CLEANOUT	100 EA	170.46	17,046.00
0210	7048500000-E	1705	PEDESTRIAN SIGNAL HEAD (16", 1 SECTION W/COUNTDOWN)	35 EA	959.50	33,582.50
0211	7060000000-E	1705	SIGNAL CABLE	24,800 LF	2.02	50,096.00
0212	7120000000-E	1705	VEHICLE SIGNAL HEAD (12", 3 SECTION)	110 EA	701.95	77,214.50

Line #	ItemNumber	Sec #	Description	Quantity Unit	Unit Bid Price	Amount Bid
0213	7132000000-E	1705	VEHICLE SIGNAL HEAD (12", 4 SECTION)	21 EA	858.50	18,028.50
0214	7144000000-E	1705	VEHICLE SIGNAL HEAD (12", 5 SECTION)	6 EA	1,313.00	7,878.00
0215	7229000000-N	SP	APS DETECTOR STATION	8 EA	808.00	6,464.00
0216	7230000000-N	SP	CENTRAL CONTROL UNIT APS DETECTOR STATION	1 EA	1,818.00	1,818.00
0217	7252000000-E	1710	MESSENGER CABLE (1/4")	925 LF	2.83	2,617.75
0218	7264000000-E	1710	MESSENGER CABLE (3/8")	5,250 LF	3.03	15,907.50
0219	7279000000-E	1715	TRACER WIRE	2,500 LF	0.76	1,900.00
0220	7288000000-E	1715	PAVED TRENCHING (*****) (1, 2")	300 LF	28.28	8,484.00
0221	7300000000-E	1715	UNPAVED TRENCHING (*****) (1, 2")	2,350 LF	5.66	13,301.00
0222	7300000000-E	1715	UNPAVED TRENCHING (*****) (2, 2")	1,335 LF	6.72	8,971.20
0223	7300000000-E	1715	UNPAVED TRENCHING (*****) (3, 2")	100 LF	18.18	1,818.00
0224	7301000000-E	1715	DIRECTIONAL DRILL (*****) (1, 2")	55 LF	15.15	833.25
0225	7301000000-E	1715	DIRECTIONAL DRILL (*****) (2, 2")	1,125 LF	15.96	17,955.00
0226	7324000000-N	1716	JUNCTION BOX (STANDARD SIZE)	50 EA	297.95	14,897.50
0227	7348000000-N	1716	JUNCTION BOX (OVER-SIZED, HEAVY DUTY)	20 EA	515.10	10,302.00
0228	7360000000-N	1720	WOOD POLE	19 EA	1,010.00	19,190.00
0229	7372000000-N	1721	GUY ASSEMBLY	41 EA	707.00	28,987.00
0230	7396000000-E	1722	1/2" RISER WITH WEATHERHEAD	2 EA	323.20	646.40

Line #	ItemNumber	Sec #	Description	Quantity Unit	Unit Bid Price	Amount Bid
0231	7408000000-E	1722	1" RISER WITH WEATHERHEAD	5 EA	353.50	1,767.50
0232	7420000000-E	1722	2" RISER WITH WEATHERHEAD	22 EA	621.15	13,665.30
0233	7430000000-N	1722	HEAT SHRINK TUBING RETROFIT KIT	5 EA	101.00	505.00
0234	7432000000-E	1722	2" RISER WITH HEAT SHRINK TUBING	3 EA	707.00	2,121.00
0235	7444000000-E	1725	INDUCTIVE LOOP SAWCUT	7,275 LF	6.82	49,615.50
0236	7456000000-E	1726	LEAD-IN CABLE (***** (14-2)	32,175 LF	1.01	32,496.75
0237	7481000000-N	SP	SITE SURVEY	5 EA	1,196.85	5,984.25
0238	7481240000-N	SP	CAMERA WITHOUT INTERNAL LOOP EMULATOR PROCESSING UNIT	17 EA	3,030.00	51,510.00
0239	7481260000-N	SP	EXTERNAL LOOP EMULATOR PROCESSING UNIT	5 EA	6,060.00	30,300.00
0240	7481280000-N	SP	RELOCATE CAMERA SENSOR UNIT	23 EA	272.70	6,272.10
0241	7516000000-E	1730	COMMUNICATIONS CABLE (**FIBER) (12)	5,425 LF	2.42	13,128.50
0242	7528000000-E	1730	DROP CABLE	450 LF	2.88	1,296.00
0243	7540000000-N	1731	SPLICE ENCLOSURE	5 EA	2,121.00	10,605.00
0244	7541000000-N	1731	MODIFY SPLICE ENCLOSURE	3 EA	858.50	2,575.50
0245	7552000000-N	1731	INTERCONNECT CENTER	6 EA	1,504.90	9,029.40
0246	7566000000-N	1733	DELINEATOR MARKER	11 EA	65.00	715.00
0247	7575142010-N	1736	900MHZ SERIAL/ETHERNET SPREAD SPECTRUM RADIO	8 EA	4,368.25	34,946.00
0248	7575142060-N	SP	MODIFY RADIO INSTALLATION	1 EA	650.44	650.44
0249	7575160000-E	1734	REMOVE EXISTING COMMUNICATIONS CABLE	3,175 LF	1.01	3,206.75



Line #	ItemNumber	Sec #	Description	Quantity Unit	Unit Bid Price	Amount Bid
0250	7575180000-N	1735	CABLE TRANSFER	1 EA	404.00	404.00
0251	7576000000-N	SP	METAL STRAIN SIGNAL POLE	20 EA	8,080.00	161,600.00
0252	7613000000-N	SP	SOIL TEST	20 EA	717.10	14,342.00
0253	7614100000-E	SP	DRILLED PIER FOUNDATION	140 CY	929.20	130,088.00
0254	7636000000-N	1745	SIGN FOR SIGNALS	63 EA	382.79	24,115.77
0255	7642100000-N	1743	TYPE I POST WITH FOUNDATION	20 EA	1,313.00	26,260.00
0256	7642200000-N	1743	TYPE II PEDESTAL WITH FOUNDATION	16 EA	2,020.00	32,320.00
0257	7648000000-N	1746	RELOCATE EXISTING SIGN	1 EA	303.00	303.00
0258	7684000000-N	1750	SIGNAL CABINET FOUNDATION	8 EA	1,313.00	10,504.00
0259	7686000000-N	1752	CONDUIT ENTRANCE INTO EXISTING FOUNDATION	10 EA	757.50	7,575.00
0260	7696000000-N	1751	CONTROLLERS WITH CABINET (***** (TYPE 2070LX, BASE MOUNTED)	9 EA	12,928.00	116,352.00
0261	7744000000-N	1751	DETECTOR CARD (TYPE 170)	89 EA	101.00	8,989.00
0262	7901000000-N	1753	CABINET BASE EXTENDER	9 EA	530.25	4,772.25
0263	7960000000-N	SP	METAL POLE FOUNDATION REMOVAL	1 EA	1,212.00	1,212.00
0264	7972000000-N	SP	METAL POLE REMOVAL	1 EA	1,010.00	1,010.00
0265	7980000000-N	SP	GENERIC SIGNAL ITEM ETHERNET EDGE SWITCH	9 EA	1,515.00	13,635.00
0266	7980000000-N	SP	GENERIC SIGNAL ITEM JUNCTION BOX MARKER	6 EA	171.70	1,030.20
0267	7980000000-N	SP	GENERIC SIGNAL ITEM REMOVE RADIO INSTALLATION	8 EA	656.50	5,252.00

Contract Item Sheets For C204603

Line #	ItemNumber	Sec #	Description	Quantity	Unit	Unit Bid Price	Amount Bid
0268	7990000000-E	SP	GENERIC SIGNAL ITEM BACK PULL FIBER OPTIC CABLE	425	LF	2.78	1,181.50

---

Contract Item Sheets For C204603

Line #	ItemNumber	Sec #	Description	Quantity Unit	Unit Bid Price	Amount Bid
0269	8801000000-E	SP	MSE RETAINING WALL NO **** (1)	1,160 SF	85.00	98,600.00
0270	8802040000-E	453	CIP GRAVITY RETAINING WALLS	325 SF	91.26	29,659.50

Line #	ItemNumber	Sec #	Description	Quantity Unit	Unit Bid Price	Amount Bid
0271	8105540000-E	411	3'-6" DIA DRILLED PIERS IN SOIL	65 LF	1,100.00	71,500.00
0272	8105640000-E	411	3'-6" DIA DRILLED PIERS NOT IN SOIL	124 LF	1,100.00	136,400.00
0273	8113000000-N	411	SID INSPECTIONS	3 EA	600.00	1,800.00
0274	8114000000-N	411	SPT TESTING	6 EA	600.00	3,600.00
0275	8115000000-N	411	CSL TESTING	3 EA	1,500.00	4,500.00
0276	8147000000-E	420	REINFORCED CONCRETE DECK SLAB	15,562 SF	65.00	1,011,530.00
0277	8161000000-E	420	GROOVING BRIDGE FLOORS	25,401.6 SF	1.00	25,401.60
0278	8182000000-E	420	CLASS A CONCRETE (BRIDGE)	297.4 CY	1,200.00	356,880.00
0279	8210000000-N	422	BRIDGE APPROACH SLABS, STATION ***** (27+02.26 -L-)	Lump Sum LS	55,000.00	55,000.00
0280	8217000000-E	425	REINFORCING STEEL (BRIDGE)	52,536 LB	1.50	78,804.00
0281	8224000000-E	425	EPOXY COATED REINFORCING STEEL (BRIDGE)	911 LB	1.75	1,594.25
0282	8238000000-E	425	SPIRAL COLUMN REINFORCING STEEL (BRIDGE)	7,630 LB	2.50	19,075.00
0283	8280000000-E	440	APPROX ..... LBS STRUCTURAL STEEL	441,500 LS	1,400,000.00	1,400,000.00
0284	8328200000-E	450	PILE DRIVING EQUIPMENT SETUP FOR *** STEEL PILES (HP 12 X 53)	16 EA	5,000.00	80,000.00
0285	8364000000-E	450	HP12X53 STEEL PILES	360 LF	65.00	23,400.00
0286	8391000000-N	450	STEEL PILE POINTS	16 EA	150.00	2,400.00
0287	8482000000-E	460	THREE BAR METAL RAIL	422.5 LF	150.00	63,375.00
0288	8524000000-E	SP	*** CHAIN LINK FENCE (104")	427.83 LF	152.00	65,030.16

Line #	ItemNumber	Sec #	Description	Quantity Unit	Unit Bid Price	Amount Bid
0289	8531000000-E	462	4" SLOPE PROTECTION	635 SY	95.00	60,325.00
0290	8559000000-E	SP	CLASS II, SURFACE PREPARATION	4.2 SY	600.00	2,520.00
0291	8657000000-N	430	ELASTOMERIC BEARINGS	Lump Sum LS	75,000.00	75,000.00
0292	8664000000-E	SP	SHOTCRETE REPAIRS	6.4 CF	2,500.00	16,000.00
0293	8678000000-E	SP	EPOXY RESIN INJECTION	1,112 LF	155.00	172,360.00
0294	8692000000-N	SP	FOAM JOINT SEALS	Lump Sum LS	42,000.00	42,000.00
0295	8727000000-N	SP	ELECTRICAL CONDUIT SYSTEM FOR SIGNALS AT STA***** (27+02.26 -L-)	Lump Sum LS	55,550.00	55,550.00
0296	8881000000-E	SP	GENERIC STRUCTURE ITEM POLYESTER POLYMER CONCRETE MATERIALS	62.1 CY	3,400.00	211,140.00
0297	8892000000-E	SP	GENERIC STRUCTURE ITEM EPOXY COATING	647 SF	40.00	25,880.00
0298	8893000000-E	SP	GENERIC STRUCTURE ITEM CONCRETE DECK REPAIR FOR POLYESTER POLYMER CONCRETE OVE RLAY	4.2 SY	150.00	630.00
0299	8893000000-E	SP	GENERIC STRUCTURE ITEM PLACING & FINISHING POLYESTER POLYMER CONCRETE OVERLAY	2,234.5 SY	56.00	125,132.00
0300	8893000000-E	SP	GENERIC STRUCTURE ITEM SCARIFYING BRIDGE DECK	1,464.5 SY	15.00	21,967.50
0301	8893000000-E	SP	GENERIC STRUCTURE ITEM SHOTBLASTING BRIDGE DECK	2,234.5 SY	5.00	11,172.50
0302	8035000000-N	402	REMOVAL OF EXISTING STRUCTURE AT STATION ***** (27+02.26 -L-)	Lump Sum LS	125,000.00	125,000.00

TOTAL AMOUNT OF BID FOR ENTIRE PROJECT

\$12,865,732.71

Contract No. C204603  
County Alamance

Rev. 1-16-18

**EXECUTION OF CONTRACT  
NON-COLLUSION, DEBARMENT AND GIFT BAN CERTIFICATION**

**CORPORATION**

The Contractor declares (or certifies, verifies, or states) under penalty of perjury under the laws of the United States that neither he, nor any official, agent or employee has entered into any agreement, participated in any collusion, or otherwise taken any action which is in restraint of free competitive bidding in connection with this Contract, that the Contractor has not been convicted of violating *N.C.G.S. § 133-24* within the last three years, and that the Contractor intends to do the work with its own bonafide employees or subcontractors and did not bid for the benefit of another contractor.

By submitting this Execution of Contract, Non-Collusion and Debarment Certification, the Contractor is certifying his status under penalty of perjury under the laws of the United States in accordance with the Debarment Certification attached, provided that the Debarment Certification also includes any required statements concerning exceptions that are applicable.

*N.C.G.S. § 133-32* and Executive Order 24 prohibit the offer to, or acceptance by, any State Employee of any gift from anyone with a contract with the State, or from any person seeking to do business with the State. By execution of any response in this procurement, you attest, for your entire organization and its employees or agents, that you are not aware that any such gift has been offered, accepted, or promised by any employees of your organization.

**SIGNATURE OF CONTRACTOR**

Zachry Construction Corporation

Full name of Corporation

P. O. Box 33240, San Antonio, TX 78265

Address as Prequalified

Attest

Kathryn Cordova  
Secretary/Assistant Secretary  
Select appropriate title

By

Samuel White  
President/Vice President/Assistant Vice President  
Select appropriate title

Kathryn Cordova

Print or type Signer's name

Samuel White

Print or type Signer's name

CORPORATE SEAL



## DEBARMENT CERTIFICATION

Conditions for certification:

1. The prequalified bidder shall provide immediate written notice to the Department if at any time the bidder learns that his certification was erroneous when he submitted his debarment certification or explanation filed with the Department, or has become erroneous because of changed circumstances.
2. The terms *covered transaction, debarred, suspended, ineligible, lower tier covered transaction, participant, person, primary covered transaction, principal, proposal, and voluntarily excluded*, as used in this provision, have the meanings set out in the Definitions and Coverage sections of the rules implementing Executive Order 12549. A copy of the Federal Rules requiring this certification and detailing the definitions and coverages may be obtained from the Contract Officer of the Department.
3. The prequalified bidder agrees by submitting this form, that he will not knowingly enter into any lower tier covered transaction with a person who is debarred, suspended, declared ineligible, or voluntarily excluded from participation in NCDOT contracts, unless authorized by the Department.
4. For Federal Aid projects, the prequalified bidder further agrees that by submitting this form he will include the Federal-Aid Provision titled *Required Contract Provisions Federal-Aid Construction Contract (Form FHWA PR 1273)* provided by the Department, without subsequent modification, in all lower tier covered transactions.
5. The prequalified bidder may rely upon a certification of a participant in a lower tier covered transaction that he is not debarred, suspended, ineligible, or voluntarily excluded from the covered transaction, unless he knows that the certification is erroneous. The bidder may decide the method and frequency by which he will determine the eligibility of his subcontractors.
6. Nothing contained in the foregoing shall be construed to require establishment of a system of records in order to render in good faith the certification required by this provision. The knowledge and information of a participant is not required to exceed that which is normally possessed by a prudent person in the ordinary course of business dealings.
7. Except as authorized in paragraph 6 herein, the Department may terminate any contract if the bidder knowingly enters into a lower tier covered transaction with a person who is suspended, debarred, ineligible, or voluntarily excluded from participation in this transaction, in addition to other remedies available by the Federal Government.

### DEBARMENT CERTIFICATION

The prequalified bidder certifies to the best of his knowledge and belief, that he and his principals:

- a. Are not presently debarred, suspended, proposed for debarment, declared ineligible, or voluntarily excluded from covered transactions by any Federal department or agency;
- b. Have not within a three-year period preceding this proposal been convicted of or had a civil judgment rendered against them for commission of fraud or a criminal offense in connection with obtaining, attempting to obtain, or performing a public (Federal, State or local) transaction or contract under a public transaction; violation of Federal or State antitrust statutes or commission of embezzlement, theft, forgery, bribery, falsification or destruction of records; making false statements; or receiving stolen property;
- c. Are not presently indicted for or otherwise criminally or civilly charged by a governmental entity (Federal, State or local) with commission of any of the offenses enumerated in paragraph b. of this certification; and
- d. Have not within a three-year period preceding this proposal had one or more public transactions (Federal, State or local) terminated for cause or default.
- e. Will submit a revised Debarment Certification immediately if his status changes and will show in his bid proposal an explanation for the change in status.

If the prequalified bidder cannot certify that he is not debarred, he shall provide an explanation with this submittal. An explanation will not necessarily result in denial of participation in a contract.

Failure to submit a non-collusion and debarment certification will result in the prequalified bidder's bid being considered non-responsive.

Check here if an explanation is attached to this certification.



**Contract No.**     **C204603**

**County (ies):**     **Alamance**

ACCEPTED BY THE  
DEPARTMENT OF TRANSPORTATION

DocuSigned by:  
*Ronald E. Davenport, Jr.*  
F81B6038A47A442...  
\_\_\_\_\_  
Contract Officer

4/7/2021  
\_\_\_\_\_  
Date

Execution of Contract and Bonds  
Approved as to Form:

DocuSigned by:  
*Jessica Price*  
\_\_\_\_\_  
Attorney General  
B584472DA33F432...

4/7/2021  
\_\_\_\_\_  
Date

Contract No.  
County

**C204603**

Alamance

Rev 5-17-11

Bond Number: 9264737 - Zurich  
82392370 - Pacific

**CONTRACT PAYMENT BOND**

Date of Payment Bond Execution March 30, 2021

Name of Principal Contractor Zachry Construction Corporation

Name of Surety: Zurich American Insurance Company, Pacific Indemnity Company

Name of Contracting Body: North Carolina Department of Transportation  
Raleigh, North Carolina

Amount of Bond: \$12,865,732.71

Contract ID No.: C204603

County Name: Alamance

KNOW ALL MEN BY THESE PRESENTS, That we, the PRINCIPAL CONTRACTOR (hereafter, PRINCIPAL) and SURETY above named, are held and firmly bound unto the above named Contracting Body, hereinafter called the Contracting Body, in the penal sum of the amount stated above for the payment of which sum well and truly to be made, we bind ourselves, our heirs, executors, administrators, and successors, jointly and severally, firmly by these presents.

THE CONDITION OF THIS OBLIGATION IS SUCH, that whereas the principal entered into a certain contract with the Contracting Body, numbered as shown above and hereto attached:

NOW THEREFORE, if the principal shall promptly make payment to all persons supplying labor and material in the prosecution of the work provided for in said contract, and any and all duly authorized modifications of said contract that may hereafter be made, notice of which modifications to the surety being hereby waived, then this obligation to be void; otherwise to remain in full force and virtue.

IN WITNESS WHEREOF, the above-bound parties have executed this instrument under their several seals on the date indicated above, the name and corporate seal of each corporate party being hereto affixed and these presents duly signed by its undersigned representative, pursuant to authority of its governing body.

Contract No.  
County

C204603

Alamance

Rev 5-17-11

**CONTRACT PAYMENT BOND**

Zurich American Insurance Company, Pacific Indemnity Company

Print or type Surety Company Name



*Affix Seal of Surety Company*

By **Donald E. Miller Jr.**

Print, stamp or type name of Attorney-in-Fact



Signature of Attorney-in-Fact

Signature of Witness

**Deborah L. Jung**

Print or type Signer's name

2330 N. Loop 1604 W, San Antonio, TX 78248

Address of Attorney-in-Fact

Contract No.  
County

C204603

Alamance

Rev 5-17-11

**CONTRACT PAYMENT BOND**

**CORPORATION**

SIGNATURE OF CONTRACTOR (Principal)

**Zachry Construction Corporation**

Full name of Corporation

**P. O. Box 33240, San Antonio, TX 78265**

Address as prequalified

By

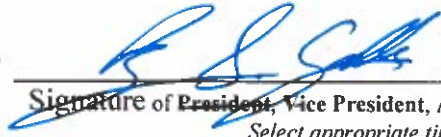

Signature of President, Vice President, Assistant Vice President  
Select appropriate title

**Bryan S. Golla**  
Vice President & Controller

Print or type Signer's name

*Affix Corporate Seal*



Attest



Signature of Secretary, Assistant Secretary  
Select appropriate title

**Kathryn Cordova**

Print or type Signer's name

Contract No. **C204603**  
County Alamance

Rev 5-17-11

Bond Number: 9264737 - Zurich  
82392370 - Pacific

**CONTRACT PERFORMANCE BOND**

Date of Performance Bond Execution: March 30, 2021  
Name of Principal Contractor: Zachry Construction Corporation  
Name of Surety: Zurich American Insurance Company, Pacific Indemnity Company  
Name of Contracting Body: North Carolina Department of Transportation  
Raleigh, North Carolina  
Amount of Bond: \$12,865,732.71  
Contract ID No.: C204603  
County Name: Alamance

KNOW ALL MEN BY THESE PRESENTS, That we, the PRINCIPAL CONTRACTOR (hereafter, PRINCIPAL) and SURETY above named, are held and firmly bound unto the above named Contracting Body, hereinafter called the Contracting Body, in the penal sum of the amount stated above for the payment of which sum well and truly to be made, we bind ourselves, our heirs, executors, administrators, and successors, jointly and severally, firmly by these presents.

THE CONDITION OF THIS OBLIGATION IS SUCH, that whereas the principal entered into a certain contract with the Contracting Body, numbered as shown above and hereto attached:

NOW THEREFORE, if the principal shall well and truly perform and fulfill all the undertakings, covenants, terms, conditions, and agreements of said contract during the original term of said contract and any extensions thereof that may be granted by the Contracting Body, with or without notice to the Surety, and during the life of any guaranty required under the contract, and shall also well and truly perform and fulfill all the undertakings, covenants, terms, conditions, and agreements of any and all duly authorized modifications of said contract that may hereafter be made, notice of which modifications to the surety being hereby waived, then this obligation to be void; otherwise to remain in full force and virtue.

IN WITNESS WHEREOF, the above-bound parties have executed this instrument under their several seals on the date indicated above, the name and corporate seal of each corporate party being hereto affixed and these presents duly signed by its undersigned representative, pursuant to authority of its governing body.

Contract No.  
County

C204603

Alamance

Rev 5-17-11

**CONTRACT PERFORMANCE BOND**

Zurich American Insurance Company, Pacific Indemnity Company

Print or type Surety Company Name

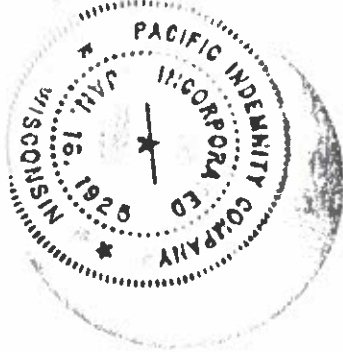
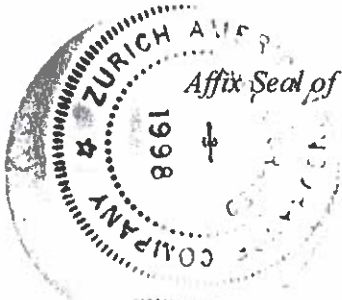

By **Donald E. Miller Jr.**

Print, stamp or type name of Attorney-in-Fact

Signature of Attorney-in-Fact

Signature of Witness

**Deborah L. Jung**

Print or type Signer's name

2330 N. Loop 1604 W, San Antonio, TX 78248

Address of Attorney-in-Fact

Contract No.  
County

C204603

Alamance

Rev 5-17-11

**CONTRACT PERFORMANCE BOND**

**CORPORATION**

SIGNATURE OF CONTRACTOR (Principal)

**Zachry Construction Corporation**

Full name of Corporation

**P. O. Box 33240, San Antonio, TX 78265**

Address as prequalified

By



Signature of ~~President~~, Vice President, Assistant Vice President  
Select appropriate title

**Bryan S. Golla**  
**Vice President & Controller**

Print or type Signer's name

*Affix Corporate Seal*



Attest



Signature of ~~Secretary~~, Assistant Secretary  
Select appropriate title



Print or type Signer's name

**ZURICH AMERICAN INSURANCE COMPANY  
COLONIAL AMERICAN CASUALTY AND SURETY COMPANY  
FIDELITY AND DEPOSIT COMPANY OF MARYLAND  
POWER OF ATTORNEY**

KNOW ALL MEN BY THESE PRESENTS: That the ZURICH AMERICAN INSURANCE COMPANY, a corporation of the State of New York, the COLONIAL AMERICAN CASUALTY AND SURETY COMPANY, a corporation of the State of Illinois, and the FIDELITY AND DEPOSIT COMPANY OF MARYLAND a corporation of the State of Illinois (herein collectively called the "Companies"), by **Robert D. Murray, Vice President**, in pursuance of authority granted by Article V, Section 8, of the By-Laws of said Companies, which are set forth on the reverse side hereof and are hereby certified to be in full force and effect on the date hereof, do hereby nominate, constitute, and appoint, **Michael N. VENSON, Donald E. MILLER, JR., Robert B. WRAY, Deborah L. JUNG, Stevens W. WARREN, Catherine M. MARTINEZ, and Thomas E. WHITNEY**, all of San Antonio, Texas, EACH, its true and lawful agent and Attorney-in-Fact, to make, execute, seal and deliver, for, and on its behalf as surety, and as its act and deed: any and all bonds and undertakings, and the execution of such bonds or undertakings in pursuance of these presents, shall be as binding upon said Companies, as fully and amply, to all intents and purposes, as if they had been duly executed and acknowledged by the regularly elected officers of the ZURICH AMERICAN INSURANCE COMPANY at its office in New York, New York., the regularly elected officers of the COLONIAL AMERICAN CASUALTY AND SURETY COMPANY at its office in Owings Mills, Maryland., and the regularly elected officers of the FIDELITY AND DEPOSIT COMPANY OF MARYLAND at its office in Owings Mills, Maryland, in their own proper persons.

The said Vice President does hereby certify that the extract set forth on the reverse side hereof is a true copy of Article V, Section 8, of the By-Laws of said Companies and is now in force.

IN WITNESS WHEREOF, the said Vice-President has hereunto subscribed his/her names and affixed the Corporate Seals of the said **ZURICH AMERICAN INSURANCE COMPANY, COLONIAL AMERICAN CASUALTY AND SURETY COMPANY, and FIDELITY AND DEPOSIT COMPANY OF MARYLAND**, this 17th day of March, A.D. 2020.

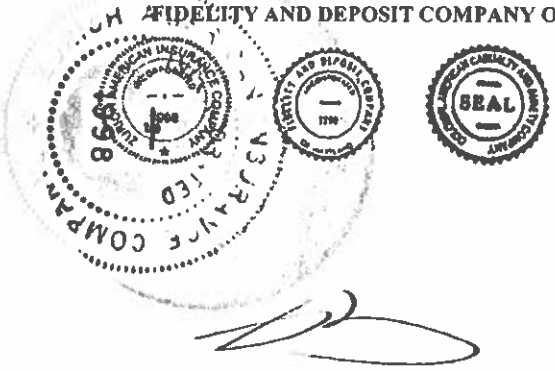

**ATTEST:  
ZURICH AMERICAN INSURANCE COMPANY  
COLONIAL AMERICAN CASUALTY AND SURETY COMPANY  
FIDELITY AND DEPOSIT COMPANY OF MARYLAND**

By: Robert D. Murray  
Vice President

Dawn E. Brown

By: Dawn E. Brown  
Secretary

**State of Maryland  
County of Baltimore**

On this 17th day of March, A.D. 2020, before the subscriber, a Notary Public of the State of Maryland, duly commissioned and qualified, **Robert D. Murray, Vice President and Dawn E. Brown, Secretary** of the Companies, to me personally known to be the individuals and officers described in and who executed the preceding instrument, and acknowledged the execution of same, and being by me duly sworn, deposed and saith, that he/she is the said officer of the Company aforesaid, and that the seals affixed to the preceding instrument are the Corporate Seals of said Companies, and that the said Corporate Seals and the signature as such officer were duly affixed and subscribed to the said instrument by the authority and direction of the said Corporations.

IN TESTIMONY WHEREOF, I have hereunto set my hand and affixed my Official Seal the day and year first above written.



Constance A. Dunn

Constance A. Dunn, Notary Public  
My Commission Expires: July 9, 2023



**EXTRACT FROM BY-LAWS OF THE COMPANIES**

"Article V, Section 8, Attorneys-in-Fact. The Chief Executive Officer, the President, or any Executive Vice President or Vice President may, by written instrument under the attested corporate seal, appoint attorneys-in-fact with authority to execute bonds, policies, recognizances, stipulations, undertakings, or other like instruments on behalf of the Company, and may authorize any officer or any such attorney-in-fact to affix the corporate seal thereto; and may with or without cause modify or revoke any such appointment or authority at any time."

**CERTIFICATE**

I, the undersigned, Vice President of the ZURICH AMERICAN INSURANCE COMPANY, the COLONIAL AMERICAN CASUALTY AND SURETY COMPANY, and the FIDELITY AND DEPOSIT COMPANY OF MARYLAND, do hereby certify that the foregoing Power of Attorney is still in full force and effect on the date of this certificate, and I do further certify that Article V, Section 8, of the By- Laws of the Companies is still in force.

This Power of Attorney and Certificate may be signed by facsimile under and by authority of the following resolution of the Board of Directors of the ZURICH AMERICAN INSURANCE COMPANY at a meeting duly called and held on the 15th day of December 1998.

RESOLVED: "That the signature of the President or a Vice President and the attesting signature of a Secretary or an Assistant Secretary and the Seal of the Company may be affixed by facsimile on any Power of Attorney...Any such Power or any certificate thereof bearing such facsimile signature and seal shall be valid and binding on the Company."

This Power of Attorney and Certificate may be signed by facsimile under and by authority of the following resolution of the Board of Directors of the COLONIAL AMERICAN CASUALTY AND SURETY COMPANY at a meeting duly called and held on the 5th day of May, 1994, and the following resolution of the Board of Directors of the FIDELITY AND DEPOSIT COMPANY OF MARYLAND at a meeting duly called and held on the 10th day of May, 1990.

RESOLVED: "That the facsimile or mechanically reproduced seal of the company and facsimile or mechanically reproduced signature of any Vice President, Secretary, or Assistant Secretary of the Company, whether made heretofore or hereafter, wherever appearing upon a certified copy of any power of attorney issued by the Company, shall be valid and binding upon the Company with the same force and effect as though manually affixed.

IN TESTIMONY WHEREOF, I have hereunto subscribed my name and affixed the corporate seals of the said Companies, this 30th day of March, 2021.

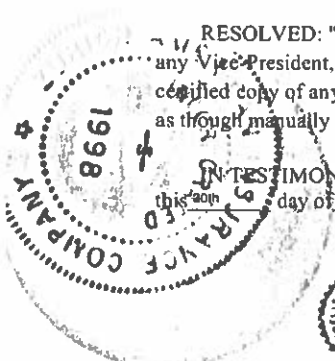

*Brian M. Hodges*

By: Brian M. Hodges  
Vice President

**TO REPORT A CLAIM WITH REGARD TO A SURETY BOND, PLEASE SUBMIT A COMPLETE DESCRIPTION OF THE CLAIM INCLUDING THE PRINCIPAL ON THE BOND, THE BOND NUMBER, AND YOUR CONTACT INFORMATION TO:**

Zurich Surety Claims  
1299 Zurich Way  
Schaumburg, IL 60196-1056  
[www.reportsfclaims@zurichna.com](http://www.reportsfclaims@zurichna.com)  
800-626-4577

**CHUBB**  
Power of Attorney

Federal Insurance Company | Vigilant Insurance Company | Pacific Indemnity Company

Know All by These Presents, That **FEDERAL INSURANCE COMPANY**, an Indiana corporation, **VIGILANT INSURANCE COMPANY**, a New York corporation, and **PACIFIC INDEMNITY COMPANY**, a Wisconsin corporation, do each hereby constitute and appoint **Deborah L. Jung, Catherine M. Martinez, Donald E. Miller Jr., Michael N. Venson, S. West Warren and Thomas E. Whitney** of San Antonio, Texas-----

each as their true and lawful Attorney-in-Fact to execute under such designation in their names and to affix their corporate seals to and deliver for and on their behalf as surety thereon or otherwise, bonds and undertakings and other writings obligatory in the nature thereof (other than bail bonds) given or executed in the course of business, and any instruments amending or altering the same, and consents to the modification or alteration of any instrument referred to in said bonds or obligations.

In Witness Whereof, said **FEDERAL INSURANCE COMPANY, VIGILANT INSURANCE COMPANY, and PACIFIC INDEMNITY COMPANY** have each executed and attested these presents and affixed their corporate seals on this 1<sup>st</sup> day of August, 2018.

*Dawn M. Chloros*

Dawn M. Chloros, Assistant Secretary

*Stephen M. Haney*

Stephen M. Haney, Vice President



STATE OF NEW JERSEY  
County of Hunterdon

On this 1<sup>st</sup> day of August, 2018, before me, a Notary Public of New Jersey, personally came Dawn M. Chloros, to me known to be Assistant Secretary of FEDERAL INSURANCE COMPANY, VIGILANT INSURANCE COMPANY, and PACIFIC INDEMNITY COMPANY, the companies which executed the foregoing Power of Attorney, and the said Dawn M. Chloros, being by me duly sworn, did depose and say that she is Assistant Secretary of FEDERAL INSURANCE COMPANY, VIGILANT INSURANCE COMPANY, and PACIFIC INDEMNITY COMPANY and knows the corporate seals thereof, that the seals affixed to the foregoing Power of Attorney are such corporate seals and were thereto affixed by authority of said Companies; and that she signed said Power of Attorney as Assistant Secretary of said Companies by like authority; and that she is acquainted with Stephen M. Haney, and knows him to be Vice President of said Companies; and that the signature of Stephen M. Haney, subscribed to said Power of Attorney is in the genuine handwriting of Stephen M. Haney, and was thereto subscribed by authority of said Companies and in deponent's presence.

Notarial Seal



KATHERINE J. ADELAAR  
NOTARY PUBLIC OF NEW JERSEY  
No. 2318606  
Commission Expires July 16, 2018

*Katherine J. Adelaar*  
Notary Public

**CERTIFICATION**

Resolutions adopted by the Boards of Directors of FEDERAL INSURANCE COMPANY, VIGILANT INSURANCE COMPANY, and PACIFIC INDEMNITY COMPANY on August 30, 2016:

"RESOLVED, that the following authorizations relate to the execution, for and on behalf of the Company, of bonds, undertakings, recognizances, contracts and other written commitments of the Company entered into in the ordinary course of business (each a "Written Commitment"):

- (1) Each of the Chairman, the President and the Vice Presidents of the Company is hereby authorized to execute any Written Commitment for and on behalf of the Company, under the seal of the Company or otherwise.
- (2) Each duly appointed attorney-in-fact of the Company is hereby authorized to execute any Written Commitment for and on behalf of the Company, under the seal of the Company or otherwise, to the extent that such action is authorized by the grant of powers provided for in such person's written appointment as such attorney-in-fact.
- (3) Each of the Chairman, the President and the Vice Presidents of the Company is hereby authorized, for and on behalf of the Company, to appoint in writing any person the attorney-in-fact of the Company with full power and authority to execute, for and on behalf of the Company, under the seal of the Company or otherwise, such Written Commitments of the Company as may be specified in such written appointment, which specification may be by general type or class of Written Commitments or by specification of one or more particular Written Commitments.
- (4) Each of the Chairman, the President and the Vice Presidents of the Company is hereby authorized, for and on behalf of the Company, to delegate in writing to any other officer of the Company the authority to execute, for and on behalf of the Company, under the Company's seal or otherwise, such Written Commitments of the Company as are specified in such written delegation, which specification may be by general type or class of Written Commitments or by specification of one or more particular Written Commitments.
- (5) The signature of any officer or other person executing any Written Commitment or appointment or delegation pursuant to this Resolution, and the seal of the Company, may be affixed by facsimile on such Written Commitment or written appointment or delegation.

FURTHER RESOLVED, that the foregoing Resolution shall not be deemed to be an exclusive statement of the powers and authority of officers, employees and other persons to act for and on behalf of the Company, and such Resolution shall not limit or otherwise affect the exercise of any such power or authority otherwise validly granted or vested."

I, Dawn M. Chloros, Assistant Secretary of FEDERAL INSURANCE COMPANY, VIGILANT INSURANCE COMPANY, and PACIFIC INDEMNITY COMPANY (the "Companies") do hereby certify that

- (i) the foregoing Resolutions adopted by the Board of Directors of the Companies are true, correct and in full force and effect,
- (ii) the foregoing Power of Attorney is true, correct and in full force and effect.

Given under my hand and seals of said Companies at Whitehouse Station, NJ, this 30th day of March, 2021.

*Dawn M. Chloros*

Dawn M. Chloros, Assistant Secretary



IN THE EVENT YOU WISH TO VERIFY THE AUTHENTICITY OF THIS BOND OR NOTIFY US OF ANY OTHER MATTER, PLEASE CONTACT US AT:  
Telephone (908) 903-3493 Fax (908) 903-3656 e-mail: surety@chubb.com